



GUSTAV BECKER

HAUPT-KATALOG 1937/38
MAIN-CATALOGUE · CATALOGUE PRINCIPAL · CATÁLOGO PRINCIPAL



UHRENFABRIKEN

Clock Factories - Fabriques d'horlogerie - Fabricas de relojes

GEBRÜDER JUNGHANS A.-G.

WERK GUSTAV BECKER

SCHRAMBERG

Schwarzwald
Black-Forest - Forêt-Noire - Selva negra



Gruppen-Verzeichnis

Index of Groups - Index des groupes - Indice por grupos

Gruppe		Seite Page	Gruppe		Seite Page
1002	Boudoir-Uhren	1		Regulateure	
1003	Boudoir clocks	3	1021	Regulators	84
1005	Pendulettes de boudoir	21		Régulateurs	
	Relojes para tocador			Reguladores	
	Wecker in Metall- und Holz- gehäusen		1023	Wanduhren	86
1008	Alarm clocks in metal and wooden cases	25	1024	Wall clocks	89
1009	Réveils en boîtes métal et bois	42	1025	Régulateurs	99
	Despertadores en cajas de metal y de madera			Reguladores	
	Schreibtischuhren		1027	Moderne Wanduhren	
1010	Writing table clocks	43		Art regulators	109
	Pendulettes de bureau			Régulateurs modernes	
	Relojes para escritorio			Reguladores estilo moderno	
	Tischuhren		1028	Hausuhren	
1017	Mantle clocks	45		Hall clocks	113
	Pendules de cheminée			Horloges de parquet	
	Relojes de sobremesa			Relojes de recibidor	
	Bürouhren — Rundrahmenuhren		1054	Kleine Wecker und Stiluhren	
1018	Dial clocks - Office clocks	61		Small alarms and boudoir clocks	9
	CEils de Bœuf - Pendules pour bureaux			Petit réveils et pendulettes de boudoir	
	Relojes de pared y para despachos			Despertadores pequeña y relojes para tocador	
	Küchenuhren				
1019	Kitchen clocks	77			
	Pendules pour cuisine				
	Relojes de cocina				



Nummern-Verzeichnis

Index of numbers - Index des numéros - Índice por números

No.	Seite Page	No.	Seite Page	No.	Seite Page
1002/72-73	1	1005/411-413 ..	22	1008/702	31
1002/78	2	1005/416-419	23	1008/703	33
1002/119	2	1005/425	24	1008/705	33
1002/121	2	1005/427	24	1008/713	34
1002/137	1	1005/435	23	1008/1000-1008 ..	36
				1008/1009-1012 ..	37
1003/141	5	1008/9-19	41	1008/1016	37
1003/175	4	1008/98-100	26	1008/1017-1019 ..	38
1003/176-178	5	1008/184-185	29	1008/1021-1024 ..	37
1003/179-180	8	1008/190-195	27	1008/1025	36
1003/209	8	1008/197-201	29	1008/1026	37
1003/212-215	6	1008/207-208	31	1008/1030-1032 ..	35
1003/217	8	1008/209-211	29	1008/1039-1040 ..	38
1003/221	8	1008/213	29	1008/1042	38
1003/225-226	4	1008/227	32	1008/1046	38
1003/228-233	7	1008/228	27	1008/1086-1089 ..	39
		1008/233	29	1008/1095	40
1054/1	9	1008/234-235	26	1008/1097-1100 ..	40
1054/3	9	1008/242	26		
1054/168-170	9	1008/246	27	1009/144	42
1054/171	10	1008/265	26	1009/159	42
1054/173-174	11	1008/276-277	28		
1054/255-257	11	1008/307	29	1010/94	44
1054/258-260	10	1008/309	28	1010/100	43
1054/261-263	12	1008/364	32	1010/102	44
1054/264-265	19	1008/373-374	30	1010/106	43
1054/266	20	1008/376-379	28		
1054/274-276	20	1008/381	34	1017/2-7	60
1054/279	19	1008/385	34	1017/954	59
1054/280	20	1008/391	34	1017/956	47
1054/1000-1007 ..	13	1008/410-411	33	1017/960	49
1054/1008-1015 ..	14	1008/439	32	1017/961	50
1054/1018-1023 ..	15	1008/474	30	1017/964	50
1054/1024-1031 ..	16	1008/476-479	28	1017/965	56
1054/1032-1037 ..	17	1008/560	30	1017/967-968	53
1054/1038-1039 ..	18	1008/571-572	32	1017/970	54
1054/1046-1047 ..	18	1008/594	28	1017/976	55
1054/1052-1053 ..	18	1008/700	30	1017/991	47



Nummern-Verzeichnis (Fortsetzung)

Index of numbers - Index des numéros - Índice por números

No.	Seite Page	No.	Seite Page	No.	Seite Page
1017/998	54	1019/441-446 ..	78	1025/560	103
1017/1091	59	1019/590-593	79	1025/561	108
1017/1239	49	1019/594-597	80	1025/562	103
1017/1241	54	1019/598-601	81	1025/564	104
1017/1245	49	1019/602-605	82	1025/566	104
1017/1246	53	1019/606-607	83	1025/568	107
1017/1251	51			1027/65-66	111
1017/1257	48	1021/12	84	1027/67-68	112
1017/1258	50	1021/32	84	1027/78-79	109
1017/1259	52	1021/53	85	1027/80	110
1017/1260	56			1027/86	110
1017/1262-1263 ..	58	1023/79	87		
1017/1273	57	1023/88	88	1028/184-185 ..	114
1017/1275	47	1023/90	88	1028/186-187	116
1017/1276	48	1023/92	88	1028/192-193	117
1017/1277	51			1028/201-202	115
1017/1279	55	1024/111-116 ..	94	1028/205	116
1017/1281	57	1024/127-129	89		
1018/1-2	63	1024/131-133	93	Werke	
1018/42	70	1024/152-154	95	Movements	
1018/71	69	1024/207-209	90	Mouvements	
1018/91-94	67	1024/210-213	91	Máquinas	
1018/96	69	1024/214-217	96	J 44	21
1018/100-103	68	1024/218-220	97	J 66	21
1018/133-144	66			10	25
1018/169-176	68	1025/362-363 ..	107	52	62,77
1018/202-213	64	1025/367-372	100	64	46,86
1018/216-236	65	1025/440	102	70	113
1018/327	71	1025/442	102	74	62
1018/338-339	71	1025/466-471	99	81	1, 3
1018/343-344	72	1025/484-488	101	146	61
1018/358	71	1025/492-493	104	184	61
1018/385-386	74	1025/522	100	200	46
1018/402	71	1025/524-525	105	225	113
1018/437-439	73	1025/527	105	231	25
1018/440	74	1025/528-529	106	239	43,61
1018/448	76	1025/530	107	247	62,77
1018/450-451	75	1025/557-558	103	250	25
1018/453	75	1025/559	108	276	45
1018/458	76			277	86
				278	45



GRUPPE 1002

Stiluhren mit flachem Weckerwerk No. 81
Boudoir clocks - Pendulettes de boudoir - Relojes para tocador

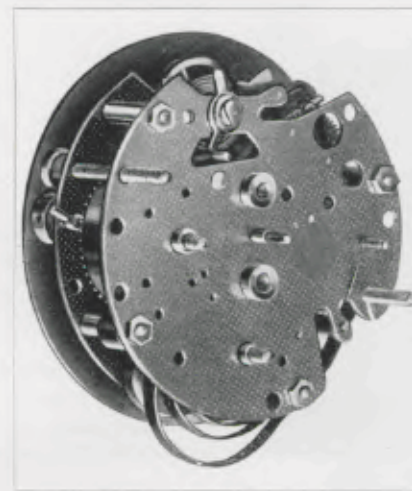

Platinen - Plates - Platines - Platinas
54x54 mm = 2 1/4 x 2 1/4 inches

No. 81

Zuverlässiges, flaches Weckerwerk, Schlag auf Werkkapsel - 1 day alarm, flat, strike on case - 30 heures réveil, plat, sonnerie sur boîte - 30 horas despertador, plano, sonería sobre caja



7x7 cm = 2 3/4 x 2 3/4 inches

1002/137 RZ

Verchromt, zweifarbiges Metallblatt mit Radiumzahlen - Chromium plated, two-coloured metal dial with luminous figures
Chromé, cadran métal bicolore avec chiffres lumineux - Cromado, esfera de metal bicolor con cifras luminosas



7,5x9 cm = 3 x 3 1/2 inches

1002/72 RZ

Verchromt, zweifarbiges Metallblatt mit Radiumzahlen - Chromium plated, two-coloured metal dial with luminous figures
Chromé, cadran métal bicolore avec chiffres lumineux - Cromado, esfera de metal bicolor con cifras luminosas



7,5x9 cm = 3 x 3 1/2 inches

1002/73 RP

Verchromt, zweifarbiges Metallblatt mit aufgelegten polierten Zahlen, Radiumpunkte und -zeiger
Chromium plated, two-coloured metal dial with polished raised figures, luminous points and hands
Chromé, cadran métal bicolore avec chiffres polis en relief, points et aiguilles lumineux
Cromado, esfera de metal bicolor con cifras pulidas en relieve, puntos y agujas luminosas

1 Tag flaches Weckerwerk No. 81 - 1 day alarm movement
Mouvement 30 heures réveil - Despertador, 30 horas cuerda



GRUPPE 1002

Stiluhren mit flachem Weckerwerk No. 81
Boudoir clocks - Pendulettes de boudoir - Relojes para tocador



1002/78 RZ

Verchromt, zweifarbiges Metallblatt mit Radiumzahlen

Chromium plated, two-coloured metal dial with luminous figures

9,5 x 11 cm = 3 3/4 x 4 1/4 inches

Chromé, cadran métal bicolore avec chiffres lumineux

Cromado, esfera de metal bicolor con cifras luminosas



1002/119 RP

Verchromt, zweifarbiges Metallblatt mit blauen Reliefzahlen, Radiumpunkte und -zeiger

Chromium plated, two-coloured metal dial with blue raised figures, luminous points and hands

8,5 x 10,5 cm = 3 3/4 x 4 1/4 inches

Chromé, cadran métal bicolore avec chiffres bleus en relief, points et aiguilles lumineux

Cromado, esfera de metal bicolor con cifras azules en relieve, puntos y agujas luminosas



1002/121 RP

Verchromt, zweifarbiges Metallblatt mit blauen Reliefzahlen, Radiumpunkte und -zeiger

Chromium plated, two-coloured metal dial with blue raised figures, luminous points and hands

9,5 x 11,5 cm = 3 3/4 x 4 1/2 inches

Chromé, cadran métal bicolore avec chiffres bleus en relief, points et aiguilles lumineux

Cromado, esfera de metal bicolor con cifras azules en relieve, puntos y agujas luminosas

1 Tag flaches Weckerwerk No. 81 - 1 day alarm movement
Mouvement 30 heures réveil - Despertador, 30 horas cuerda



GRUPPE 1003

Boudoir-Uhren mit halbflachem Weckerwerk, mit Glocke und Knopfabsteller
Boudoir clocks - Pendulettes de boudoir - Relojes para tocador

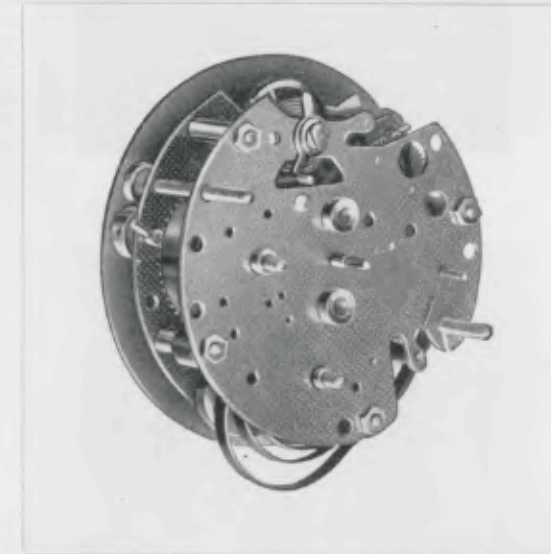

Platinen - Plates - Platines - Platinas
54 x 54 mm = 2 1/4 x 2 1/4 inches

No. 81

1 Tag halbflaches Weckerwerk mit Glocke und Knopfabsteller

1 day alarm, semi-flat, with bell and stopper

30 heures réveil, mi-plat, avec cloche et arrêt à bouton

30 horas despertador, medio plana, con campana para despertador por medio del botón



GRUPPE 1003

Boudoir-Uhren mit halbflachem Weckerwerk, mit Glocke und Knopfabsteller

Boudoir clocks - Pendulettes de boudoir - Relojes para tocador

1003/225 RP

Verchromt poliert, bombiertes Glas, zweifarbiges Metallblatt mit aufgelegten Goldzahlen, Radiumpunkte und -zeiger, 1 Tag Weckerwerk No. 81

Chromium plated polished, convex glass, two-coloured metal dial with gilt raised figures, luminous points and hands, 1 day alarm movement



7,5 x 7,5 cm = 3 x 3 inches

Chromé poli, verre bombé, cadran métal bicolore avec chiffres dorés en relief, points et aiguilles lumineux, 30 heures réveil mouvement

Cromado pulido, cristal bombado, esfera de metal bicolor con cifras doradas en relieve, puntos y agujas luminosas, despertador, 30 horas cuerda

1003/226 RP

Verchromt poliert, bombiertes Glas, zweifarbiges Metallblatt mit aufgelegten Goldzahlen, Radiumpunkte und -zeiger, 1 Tag Weckerwerk No. 81

Chromium plated polished, convex glass, two-coloured metal dial with gilt raised figures, luminous points and hands, 1 day alarm movement



7,5 x 7,5 cm = 3 x 3 inches

Chromé poli, verre bombé, cadran métal bicolore avec chiffres dorés en relief, points et aiguilles lumineux, 30 heures réveil mouvement

Cromado pulido, cristal bombado, esfera de metal bicolor con cifras doradas en relieve, puntos y agujas luminosas, despertador, 30 horas cuerda

1003/175 RP

Verchromt mit vergoldetem Zwischenstück und brüniertem Sockel, zweifarbiges Metallblatt mit aufgelegten Chromzahlen, Radiumpunkte und -zeiger, 1 Tag Weckerwerk No. 81

Chromium plated, gilt and browned, two-coloured metal dial with chromium raised figures, luminous points and hands, 1 day alarm movement



8 x 7,5 cm = 3 1/4 x 3 inches

Chromé, doré et bruni, cadran métal bicolore avec chiffres chromés en relief, points et aiguilles lumineux, 30 heures réveil mouvement

Cromado, dorado y marrón, esfera de metal bicolor con cifras cromadas en relieve, puntos y agujas luminosas, despertador, 30 horas cuerda



GRUPPE 1003

Boudoir-Uhren mit halbflachem Weckerwerk, mit Glocke und Knopfabsteller

Boudoir clocks - Pendulettes de boudoir - Relojes para tocador

1003/141 RP

Verchromt, Silberblatt mit aufgelegten Chromzahlen, Radiumpunkte und -zeiger, Facetteglas, 1 Tag Weckerwerk No. 81

Chromium plated silver dial with raised chrome figures, luminous points and hands, bevelled glass, 1 day alarm movement

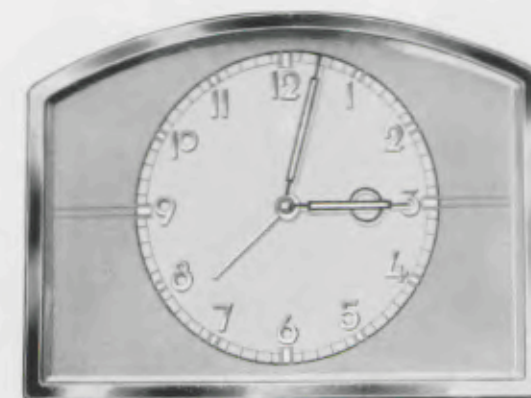

11 x 14,5 cm = 4 1/4 x 5 3/4 inches

Chromé, cadran argenté avec chiffres appliqués chromés, points et aiguilles lumineux, verre à biseau, 30 heures réveil mouvement

Cromado, esfera plateada con cifras cromadas en relieve, puntos y agujas luminosas, cristal biselado, despertador, 30 horas cuerda

1003/176 RP

Verchromt mit vergoldetem Zwischenstück und brüniertem Sockel, zweifarbiges Metallblatt mit aufgelegten Chromzahlen, Radiumpunkte und -zeiger, 1 Tag Weckerwerk No. 81

Chromium plated, gilt and browned, two-coloured metal dial with chromium raised figures, luminous points and hands, 1 day alarm movement



8 x 10,5 cm = 3 1/4 x 4 1/4 inches

Chromé, doré et bruni, cadran métal bicolore avec chiffres chromés en relief, points et aiguilles lumineux, 30 heures réveil mouvement

Cromado, dorado y marrón, esfera de metal bicolor con cifras cromadas en relieve, puntos y agujas luminosas, despertador, 30 horas cuerda

1003/177 RP

1 Tag Weckerwerk No. 81 - 1 day alarm movement - 30 heures réveil Despertador, 30 horas cuerda

1003/178

8 Tag Ankergehwerk No. 240 8 day lever time movement - Mouvement 8 jours simple à ancre - Mâquins 8 días cuerda à ancora

Verchromt, poliert und geschliffen Metallblatt mit aufgelegten Chromzahlen, Radiumpunkte und -zeiger



8,5 x 11,5 cm = 3 3/8 x 4 1/2 inches

Chromé, poli et affiné, cadran métal avec chiffres chromés en relief, points et aiguilles lumineux

Cromado, pulido y biselado, esfera de metal con cifras cromadas en relieve, puntos y agujas luminosas

Cromado, pulido y biselado, esfera de metal con cifras cromadas en relieve, puntos y agujas luminosas



GRUPPE 1003

Boudoir-Uhren mit halbflachem Weckerwerk, mit Glocke und Knopfabsteller
Boudoir clocks - Pendulettes de boudoir - Relojes para tocador



10,5 x 15 cm = 4 1/4 x 6 inches

1003/212 RP

1 Tag Weckerwerk No. 81 - 1 day alarm movement
30 heures réveil - Despertador, 30 horas cuerdas

1003/213

8 Tag Ankergehwerk No. 240 - 8 day lever time movement - Mouvement 8 jours simple à ancre
Máquina 8 días cuerdas à âncora

Verchromt poliert, Metallblatt mit aufgelegten Chromzahlen, Radiumpunkte und -zeiger - Chromium plated polished, metal dial with chromium raised figures, luminous points and hands - Chromé poli, cadran métal avec chiffres chromés en relief, points et aiguilles lumineux - Cromado pulido, esfera de metal con cifras cromadas en relieve, puntos y agujas luminosos



11,5 x 15 cm = 4 1/2 x 6 inches

1003/214 RP

Verchromt poliert mit vergoldeten Füßen, zweifarbigen Metallblatt mit aufgelegten Chromzahlen, Radiumpunkte und -zeiger, 8 Tag Ankergehwerk No. 240

Chromium plated polished with gilt feet, two-coloured metal dial with chromium raised figures, luminous points and hands, 8 day lever time movement

Chromé poli avec pieds dorés, cadran métal bicolore avec chiffres chromés en relief, points et aiguilles lumineux, mouvement 8 jours simple, échappement à ancre

Cromado pulido con pies dorados, esfera de metal bicolore con cifras cromadas en relieve, puntos y agujas luminosos, máquina 8 días cuerdas, escape à âncora

1036/3/214 RP

Synchronegehwerk - Synchronous movement
Mouvement Synchron - Máquina Sincron



11,5 x 15 cm = 4 1/2 x 6 inches

1003/215 RP

Vergoldet, zweifarbigen Metallblatt mit aufgelegten Goldzahlen, Radiumpunkte und -zeiger, 8 Tag Ankergehwerk No. 240

Gilt, two-coloured metal dial with gilt raised figures, luminous points and hands, 8 day lever time movement

Doré, cadran métal bicolore avec chiffres dorés en relief, points et aiguilles lumineux, mouvement 8 jours simple, échappement à ancre

Dorado, esfera de metal bicolore con cifras doradas en relieve, puntos y agujas luminosos, máquina 8 días cuerdas, escape à âncora



GRUPPE 1003

Boudoir-Uhren mit halbflachem Weckerwerk, mit Glocke und Knopfabsteller
Boudoir clocks - Pendulettes de boudoir - Relojes para tocador



12 x 15,5 cm = 4 3/4 x 6 inches

Blaues Glas - Blue plate glass - Verre bleu - Cristal azul

1003/228 RP 1 Tag Weckerwerk No. 81 - 1 day alarm - 30 heures réveil - 30 horas despertador

1003/229 8 Tag Ankergehwerk No. 240 - 8 day lever time movement
Mouvement 8 jours simple à ancre - Máquina 8 días cuerdas à âncora

Schwarzes Glas - Black plate glass - Verre noir - Cristal negro

1003/230 RP 1 Tag Weckerwerk No. 81 - 1 day alarm - 30 heures réveil - 30 horas despertador

1003/231 8 Tag Ankergehwerk No. 240 - 8 day lever time movement
Mouvement 8 jours simple à ancre - Máquina 8 días cuerdas à âncora

Chromlunette, matt versilberter Zahlenreif - Chromium plated bezel, mat-silvered figure-circle
Lunette chromée, cercle à chiffres argenté mat - Bisel cromado, cerco de cifras plateado mate



12 x 15,5 cm = 4 3/4 x 6 inches

Bernsteinglas - Amber glass frame - Verre couleur ambre jaune - Cristal color ambar

1003/232 RP 1 Tag Weckerwerk No. 81 - 1 day alarm - 30 heures réveil - 30 horas despertador

1003/233 8 Tag Ankergehwerk No. 240 - 8 day lever time movement
Mouvement 8 jours simple à ancre - Máquina 8 días cuerdas à âncora

Goldlunette, matt vergoldeter Zahlenreif - Gilt bezel, mat gilt figure-circle
Lunette dorée, cercle à chiffres doré mat - Bisel dorado, cerco de cifras dorado mate



GRUPPE 1003

Boudoir-Uhren mit halbflachem Weckerwerk, mit Glocke und Knopfabsteller

Boudoir clocks - Pendulettes de boudoir - Relojes para tocar

1003/179 RP

1 Tag Weckerwerk No. 81 - 1 day alarm movement - 30 heures réveil - Despertador, 30 horas cuerda

1003/180

8 Tag Ankergehwerk No. 240 - 8 day lever time movement - Mouvement 8 jours simple à ancre - Máquina 8 días cuerda á áncora

1003/209

1 Tag Schlagwerk No. 245 auf Glocke 1 day strike on bell - 30 heures sonnerie sur cloche - 30 horas soneria sobre campana



8,5 x 11,5 cm = 3 3/4 x 4 1/2 inches

Verchromt, poliert und guillochiert, zweifarbige Metallblatt mit aufgelegten Chromzahlen, Radiumpunkten und -zeiger - Chromium plated, polished and engine-turned, two-coloured metal dial with chromium raised figures, luminous points and hands - Chromé, poli et guilloché, cadran métal bicolore avec chiffres chromés en relief, points et aiguilles lumineux - Cromado, pulido y grabado, esfera de metal bicolor con cifras cromadas en relieve, puntos y agujas luminosos

1003/217

Verchromt und verkupfert mit Kristallglas, zweifarbige Metallblatt mit aufgelegten Chromzahlen, 8 Tag Ankergehwerk No. 240

Chromium plated and coppered with plate-glass, two-coloured metal dial with chromium raised figures, 8 day lever time movement



11,5 x 21,5 cm = 4 1/2 x 8 1/2 inches

Chromé et cuivré avec verre, cadran métal bicolore avec chiffres chromés en relief, mouvement 8 jours simple à ancre - Cromado y color cobre con cristal, esfera de metal bicolor con cifras cromadas en relieve, máquina 8 días cuerda á áncora

1003/221

Nußbaum feinmatt, antik, mit vergoldetem Sockel, aufgelegte vergoldete Zahlen und Zeiger, 8 Tag Ankergehwerk No. 240

Dull antique figured walnut with gilt socle, gilt raised figures and hands, 8 day lever time movement

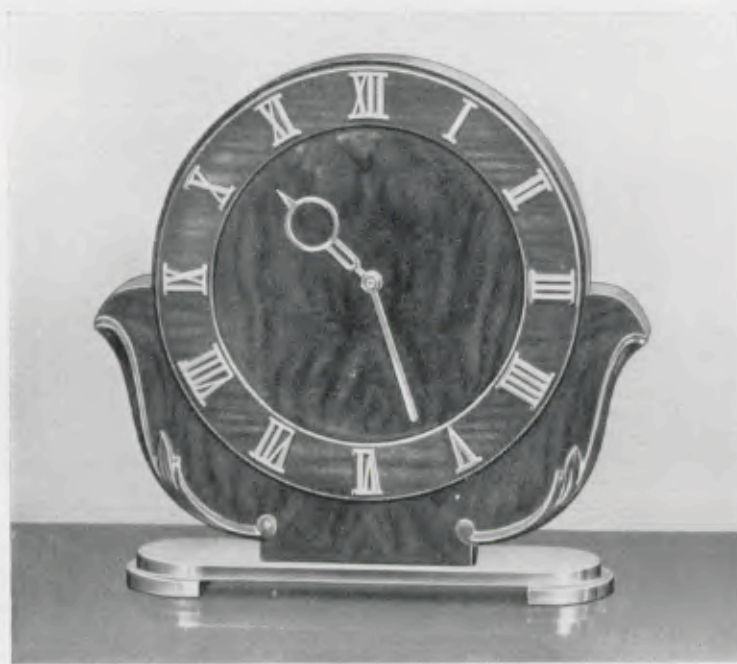

17,5 x 16,5 cm = 6 7/8 x 6 1/2 inches

Noyer mat antique avec socle doré, chiffres appliqués et aiguilles dorés, mouvement 8 jours simple à ancre - Nogal mate antiguo con zócalo dorado, cifras aplicadas y agujas doradas, máquina 8 días cuerda á áncora

1036/3/221

Synchrongehwerk - Synchronous movement - Mouvement Synchron - Máquina Sincron



GRUPPE 1054

Kleine Wecker mit Hohltriebwerk ohne Federhaus

Small alarms, movement with lantern pinions, without spring-barrel - Petit réveils, mouvement avec pignons lanternes, sans barillet - Despertadores pequeña, máquina con piones de linterna, sin barrilete

1054/1

1 Tag Gehwerk - 1 day time - 30 heures simple - 30 horas cuerda Metallgehäuse vernickelt, weißes Kartonblatt



8,5 cm = 3 3/4 inches

Metal case nickelled, white cardboard dial Boîte métal nickelé, cadran carton blanc Caja de metal niquelado, esfera blanca de cartón

1054/3

1 Tag Wecker - 1 day alarm - 30 heures réveil - 30 horas despertador Metallgehäuse vernickelt, weißes Kartonblatt



10,5 cm = 4 1/4 inches

Metal case nickelled, white cardboard dial Boîte métal nickelé, cadran carton blanc Caja de metal niquelado, esfera blanca de cartón

1054/168

1 Tag Wecker - 1 day alarm - 30 heures réveil - 30 horas despertador Rotbraun - Claret coloured Brun-rouge - Rojo oscuro Weißes Kartonblatt - White cardboard dial - Cadran carton blanc - Esfera blanca de cartón



7,5 cm = 3 inches

1054/169

1 Tag Wecker - 1 day alarm - 30 heures réveil - 30 horas despertador Blau - Blue - Bleu - Azul Weißes Kartonblatt - White cardboard dial - Cadran carton blanc - Esfera blanca de cartón

1054/170

1 Tag Wecker - 1 day alarm - 30 heures réveil - 30 horas despertador Vernickelt mit rotem Band, Silberblatt Nickelled with red enamelled centre-band, silver dial



7,5 cm = 3 inches

Nickelé avec bande émaillée rouge, cadran argenté Niquelado con cinta esmaltada roja, esfera plateada



GRUPPE 1054

Kleine Wecker mit Hohltriebwerk ohne Federhaus

Small alarms, movement with lantern pinions, without spring-barrel - Petit réveils, mouvement avec pignons lanternes, sans barillet - Despertadores pequeña, máquina con piñones de linterna, sin barrilete

1054/171

Vernickelt mit blauem Band

Nickelled with blue enamelled centre-band

Nickelé avec bande émaillée bleue

Niquelado con cinta esmaltada azul



7,5 cm = 3 inches

1 Tag Wecker, Silberblatt

1 day alarm, silver dial

30 heures réveil, cadran argenté

30 horas despertador, esfera plateada

1054/260

Vernickelt mit elfenbeinfarbigem Band, Silberblatt, 1 Tag Weckerwerk

Nickelled with ivory colour centre-band, silver dial, 1 day alarm movement

Nickelé avec bande beige, cadran argenté, 30 heures réveil

Niquelado con cinta color marfil, esfera plateada, despertador, 30 horas cuerda



7,5 cm = 3 inches

Nickelé avec bande beige, cadran argenté, 30 heures réveil

Niquelado con cinta color marfil, esfera plateada, despertador, 30 horas cuerda

1054/258

Blau - Blue - Bleu - Azul

1054/259

Hellrot - Red - Rouge - Rojo

Weißblatt, 1 Tag Weckerwerk, Bügelabsteller



8 cm = 3 1/4 inches

White dial, 1 day alarm movement, the alarm is stopped by pushing the handle down

Cadran blanc, 30 heures réveil, arrêtage du réveil par la poignée

Esfera blanca, despertador, 30 horas cuerda, el despertador se para doblando la manija



GRUPPE 1054

Kleine Wecker mit Hohltriebwerk ohne Federhaus

Small alarms, movement with lantern pinions, without spring-barrel - Petit réveils, mouvement avec pignons lanternes, sans barillet - Despertadores pequeña, máquina con piñones de linterna, sin barrilete



7,5 cm = 3 inches

1054/173

Vernickelt mit rotem Band

Nickelled with red enamelled centre-band

Nickelé avec bande émaillée rouge

Niquelado con cinta esmaltada roja



7,5 cm = 3 inches

1054/174

Vernickelt mit blauem Band

Nickelled with blue enamelled centre-band

Nickelé avec bande émaillée bleue

Niquelado con cinta esmaltada azul

Silberblatt

Silver dial - Cadran argenté - Esfera plateada



7,5 cm = 3 inches

1054/255

Blau - Blue - Bleu - Azul

1054/256

Hellrot - Red - Rouge - Rojo

Goldblatt - Gilt dial

Cadran doré - Esfera dorada

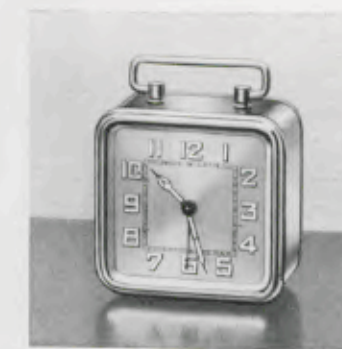

7,5 cm = 3 inches

1054/257

Verchromt, Silberblatt

Chromium plated, silver dial

Chromé, cadran argenté

Cromado, esfera plateada

1 Tag Weckerwerk, Bügelabsteller

1 day alarm movement, the alarm is stopped by pushing the handle down

30 heures réveil, arrêtage du réveil par la poignée

Despertador, 30 horas cuerda, el despertador se para doblando la manija



GRUPPE 1054

Kleine Wecker

Small alarms - Petit réveils - Despertadores pequeña

1054/261

Vernickelt mit blauem Band
Nickelled with blue centre-band
Nickelé avec ruban bleu
Niquelado con cinta azul



8,5 cm = 3 3/8 inches

1054/262

Vernickelt mit rotem Band
Nickelled with red centre-band
Nickelé avec ruban rouge
Niquelado con cinta roja

1054/263

Vernickelt mit elfenbeinfarbigem Band
Nickelled with ivory colour centre-band



8,5 cm = 3 3/8 inches

1 Tag Weckerwerk No. 81, zweifarbiges Metallblatt
1 day alarm movement, two-coloured metal dial
30 heures réveil - cadran métal bicolore
Despertador, 30 horas cuerda, esfera de metal bicolor



GRUPPE 1054

Stiluhren mit Hohltriebwerk ohne Federhaus

Boudoir clocks, movement with lantern pinions, without spring-barrel - Pendulettes de boudoir, mouvement avec pignons lanternes, sans barillet - Relojes para tocador, máquina con piñones de linterna, sin barrilete



6,5 x 6,5 cm = 2 1/2 x 2 1/2 inches



6,5 x 6,5 cm = 2 1/2 x 2 1/2 inches

1054/1000 N
Nickel - Nickelled - Nickelé - Niquelado

1054/1000 C
Chrom - Chromium plated - Chromé - Cromado
1 Tag Gehwerk - 1 day time
30 heures simple - 30 horas cuerda

1054/1001 C
Chrom - Chromium plated - Chromé - Cromado
1 Tag Wecker - 1 day alarm
30 heures réveil - 30 horas despertador
Metallblatt, bombiertes Glas
Metal dial, convex glass - Cadran métal, verre bombé
Esfera de metal, vidrio bombado

1054/1002 N
Nickel - Nickelled - Nickelé - Niquelado

1054/1002 C
Chrom - Chromium plated - Chromé - Cromado
1 Tag Gehwerk - 1 day time
30 heures simple - 30 horas cuerda

1054/1003 C
Chrom - Chromium plated - Chromé - Cromado
1 Tag Wecker - 1 day alarm
30 heures réveil - 30 horas despertador
Zweifarbigen Metallblatt - Two-coloured metal dial
Cadran métal bicolore - Esfera de metal bicolor



8 x 8 cm = 3 1/4 x 3 1/4 inches



8 x 8 cm = 3 1/4 x 3 1/4 inches

1054/1004 N
Nickel - Nickelled - Nickelé - Niquelado

1054/1004 C
Chrom - Chromium plated - Chromé - Cromado
1 Tag Gehwerk - 1 day time
30 heures simple - 30 horas cuerda

1054/1005 C
Chrom - Chromium plated - Chromé - Cromado
1 Tag Wecker - 1 day alarm
30 heures réveil - 30 horas despertador
Metallblatt - Metal dial - Cadran métal - Esfera de metal

1054/1006 N
Nickel - Nickelled - Nickelé - Niquelado

1054/1006 C
Chrom - Chromium plated - Chromé - Cromado
1 Tag Gehwerk - 1 day time
30 heures simple - 30 horas cuerda

1054/1007 C
Chrom - Chromium plated - Chromé - Cromado
1 Tag Wecker - 1 day alarm
30 heures réveil - 30 horas despertador
Metallblatt - Metal dial - Cadran métal - Esfera de metal



GRUPPE 1054

Stiluhren mit Hohltriebwerk ohne Federhaus

Boudoir clocks, movement with lantern pinions, without spring-barrel - Pendulettes de boudoir, mouvement avec pignons lanternes, sans barillet - Relojes para tocador, máquina con piñones de linterna, sin barrilete



8 x 8 cm = 3 1/8 x 3 1/8 inches

1054/1008 C

Chrom, 1 Tag Gehwerk - Chromium plated, 1 day time
Chromé, 30 heures simple - Cromado, 30 horas cuerda

1054/1009 C

Chrom, 1 Tag Wecker - Chromium plated, 1 day alarm
Chromé, 30 heures réveil - Cromado, 30 horas despertador

Zweifarbigen Metallblatt mit Relieffzahlen
Two-coloured metal dial with raised figures
Cadran métal bicolore avec chiffres relief
Esfera de metal bicolor con cifras en relieve



10 x 10 cm = 4 x 4 inches

1054/1012 N

Nickel - Nickelled - Nickelé - Niquelado

1054/1012 C

Chrom - Chromium plated - Chromé - Cromado
1 Tag Gehwerk - 1 day time
30 heures simple - 30 horas cuerda

1054/1013 C

Chrom - Chromium plated - Chromé - Cromado
1 Tag Wecker - 1 day alarm
30 heures réveil - 30 horas despertador

Metallblatt - Metal dial
Cadran métal - Esfera de metal



9 x 12 cm = 3 1/2 x 4 3/4 inches

1054/1010 C

Chrom, 1 Tag Gehwerk - Chromium plated, 1 day time
Chromé, 30 heures simple - Cromado, 30 horas cuerda

1054/1011 C

Chrom, 1 Tag Wecker - Chromium plated, 1 day alarm
Chromé, 30 heures réveil - Cromado, 30 horas despertador

Metallblatt - Metal dial - Cadran métal - Esfera de metal



10 x 10 cm = 4 x 4 inches

1054/1014 N

Nickel - Nickelled - Nickelé - Niquelado

1054/1014 C

Chrom - Chromium plated - Chromé - Cromado
1 Tag Gehwerk - 1 day time
30 heures simple - 30 horas cuerda

1054/1015 C

Chrom - Chromium plated - Chromé - Cromado
1 Tag Wecker - 1 day alarm
30 heures réveil - 30 horas despertador

Zweifarbigen Metallblatt - Two-coloured metal dial
Cadran métal bicolore - Esfera de metal bicolor



GRUPPE 1054

Stiluhren mit Hohltriebwerk ohne Federhaus

Boudoir clocks, movement with lantern pinions, without spring-barrel - Pendulettes de boudoir, mouvement avec pignons lanternes, sans barillet - Relojes para tocador, máquina con piñones de linterna, sin barrilete



10,5 x 15 cm = 4 1/8 x 6 inches

1054/1018 C

Chrom, 1 Tag Gehwerk
Chromium plated, 1 day time
Chromé, 30 heures simple
Cromado, 30 horas cuerda

1054/1019 C

Chrom, 1 Tag Wecker
Chromium plated, 1 day alarm
Chromé, 30 heures réveil
Cromado, 30 horas despertador

Zweifarbigen Metallblatt
Two-coloured metal dial
Cadran métal bicolore
Esfera de metal bicolor



12,5 x 12,5 cm = 5 x 5 inches

1054/1020 C

Chrom, 1 Tag Gehwerk
Chromium plated, 1 day time
Chromé, 30 heures simple
Cromado, 30 horas cuerda

1054/1021 C

Chrom, 1 Tag Wecker
Chromium plated, 1 day alarm
Chromé, 30 heures réveil
Cromado, 30 horas despertador

Metallblatt - Metal dial
Cadran métal - Esfera de metal



12,5 x 12,5 cm = 5 x 5 inches

1054/1022 C

Chrom, 1 Tag Gehwerk
Chromium plated, 1 day time
Chromé, 30 heures simple
Cromado, 30 horas cuerda

1054/1023 C

Chrom, 1 Tag Wecker
Chromium plated, 1 day alarm
Chromé, 30 heures réveil
Cromado, 30 horas despertador

Zweifarbigen Metallblatt - Two-coloured metal dial
Cadran métal bicolore - Esfera de metal bicolor



GRUPPE 1054

Stiluhren mit Hohltriebwerk ohne Federhaus

Boudoir clocks, movement with lantern pinions, without spring-barrel - Pendulettes de boudoir, mouvement avec pignons lanternes, sans barillet - Relojes para tocador, máquina con piñones de linterna, sin barrilete



7,5 x 11,5 cm = 3 x 4 1/2 inches

1054/1024 N

Nickel - Nickelled - Nickelé - Niquelado

1054/1024 C

Chrom - Chromium plated - Chromé - Cromado

1 Tag Gehwerk - 1 day time
30 heures simple - 30 horas cuerda

1054/1025 C

Chrom - Chromium plated - Chromé - Cromado

1 Tag Wecker - 1 day alarm
30 heures réveil - 30 horas despertador

Metallblatt - Metal dial - Cadran métal - Esfera de metal



8 x 11,5 cm = 3 1/4 x 4 1/4 inches

1054/1026 N

Nickel - Nickelled - Nickelé - Niquelado

1054/1026 C

Chrom - Chromium plated - Chromé - Cromado

1 Tag Gehwerk - 1 day time
30 heures simple - 30 horas cuerda

1054/1027 C

Chrom - Chromium plated - Chromé - Cromado

1 Tag Wecker - 1 day alarm
30 heures réveil - 30 horas despertador

Metallblatt - Metal dial - Cadran métal - Esfera de metal



8,5 x 8,5 cm = 3 3/4 x 3 3/4 inches

1054/1028 N

Nickel - Nickelled - Nickelé - Niquelado

1054/1028 C

Chrom - Chromium plated - Chromé - Cromado

1 Tag Gehwerk - 1 day time
30 heures simple - 30 horas cuerda

1054/1029 C

Chrom - Chromium plated - Chromé - Cromado

1 Tag Wecker - 1 day alarm
30 heures réveil - 30 horas despertador

Metallblatt - Metal dial - Cadran métal - Esfera de metal



10 x 9 cm = 4 x 3 1/2 inches

1054/1030 C

Chrom, 1 Tag Gehwerk - Chromium plated, 1 day time
Chromé, 30 heures simple - Cromado, 30 horas cuerda

1054/1031 C

Chrom, 1 Tag Wecker - Chromium plated, 1 day alarm
Chromé, 30 heures réveil - Cromado, 30 horas despertador

Metallblatt - Metal dial - Cadran métal - Esfera de metal



GRUPPE 1054

Stiluhren mit Hohltriebwerk ohne Federhaus

Boudoir clocks, movement with lantern pinions, without spring-barrel - Pendulettes de boudoir, mouvement avec pignons lanternes, sans barillet - Relojes para tocador, máquina con piñones de linterna, sin barrilete



8,5 x 9 cm = 3 3/4 x 3 1/2 inches

1054/1032 N

Vernickelt, 1 Tag Gehwerk - Nickelled, 1 day time
Nickelé, 30 heures simple - Niquelado, 30 horas cuerda

1054/1032 C

Verchromt, 1 Tag Gehwerk - Chromium plated, 1 day time
Chromé, 30 heures simple - Cromado, 30 horas cuerda

1054/1033 C

Verchromt, 1 Tag Wecker - Chromium plated, 1 day alarm
Chromé, 30 heures réveil - Cromado, 30 horas despertador

Kartonblatt - Cardboard dial
Cadran carton - Esfera de cartón



8,5 x 9 cm = 3 3/4 x 3 1/2 inches

1054/1034 N

Vernickelt, 1 Tag Gehwerk - Nickelled, 1 day time
Nickelé, 30 heures simple - Niquelado, 30 horas cuerda

1054/1034 C

Verchromt, 1 Tag Gehwerk - Chromium plated, 1 day time
Chromé, 30 heures simple - Cromado, 30 horas cuerda

1054/1035 C

Verchromt, 1 Tag Wecker - Chromium plated, 1 day alarm
Chromé, 30 heures réveil - Cromado, 30 horas despertador

Metallblatt - Metal dial
Cadran métal - Esfera de metal



8 x 11,5 cm = 3 1/4 x 4 1/2 inches

1054/1036 N

Vernickelt, 1 Tag Gehwerk - Nickelled, 1 day time
Nickelé, 30 heures simple - Niquelado, 30 horas cuerda

1054/1036 C

Verchromt, 1 Tag Gehwerk - Chromium plated, 1 day time
Chromé, 30 heures simple - Cromado, 30 horas cuerda

1054/1037 C

Verchromt, 1 Tag Wecker - Chromium plated, 1 day alarm
Chromé, 30 heures réveil - Cromado, 30 horas despertador

Kartonblatt - Cardboard dial
Cadran carton - Esfera de cartón



GRUPPE 1054

Stiluhren mit Hohltriebwerk ohne Federhaus

Boudoir clocks, movement with lantern pinions, without spring-barrel - Pendulettes de boudoir, mouvement avec pignons lanternes, sans barillet - Relojes para tocador, máquina con piñones de linterna, sin barrilete



8 x 11,5 cm = 3 1/4 x 4 1/2 inches

1054/1038 N

Vernickelt, 1 Tag Gehwerk - Nickelled, 1 day time
Nickelé, 30 heures simple - Niquelado, 30 horas cuerda

1054/1038 C

Verchromt, 1 Tag Gehwerk - Chromium plated, 1 day time
Chromé, 30 heures simple - Cromado, 30 horas cuerda

1054/1039 C

Verchromt, 1 Tag Wecker - Chromium plated, 1 day alarm
Chromé, 30 heures réveil - Cromado, 30 horas despertador

Zweifarbigen Metallblatt mit aufgelegten Chromzahlen - Two-coloured metal dial with chromium plated raised figures
Cadran métal bicolore avec chiffres chromés en relief - Esfera de metal bicolor con cifras cromadas en relieve

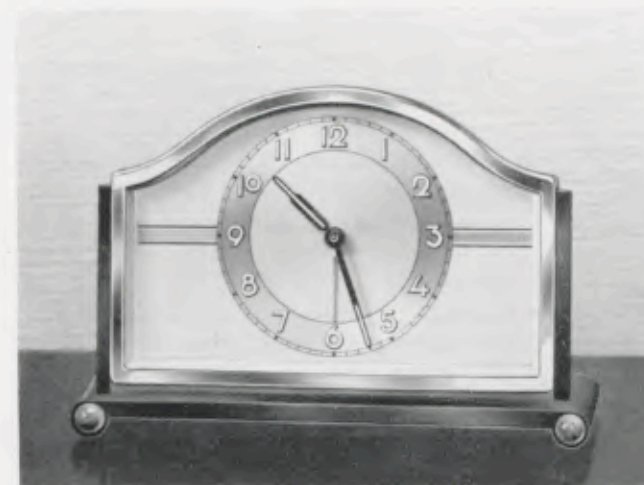

9,5 x 14 cm = 3 3/4 x 5 1/2 inches

1054/1052 C

1 Tag Gehwerk - 1 day time
30 heures simple - 30 horas cuerda

1054/1053 C

1 Tag Wecker - 1 day alarm
30 heures réveil - 30 horas despertador

Verchromt mit schwarzen und roten Einlagen, zweifarbigen Metallblatt
Chromium plated with black and red inlays, two-coloured metal dial
Chromé avec incrustations noires et rouges, cadran métal bicolore
Cromado con incrustaciones negras y encarnadas, esfera de metal bicolor



9 x 16 cm = 3 1/2 x 6 1/4 inches

1054/1046 C

1 Tag Gehwerk - 1 day time
30 heures simple - 30 horas cuerda

1054/1047 C

1 Tag Wecker - 1 day alarm
30 heures réveil - 30 horas despertador

Verchromt mit blauer Einlage, zweifarbigen Metallblatt
Chromium plated with blue inlay, two-coloured metal dial
Chromé avec incrustation bleue, cadran métal bicolore
Cromado con incrustaciones azules, esfera de metal bicolor



GRUPPE 1054

Kleine Holzwecker mit Hohltriebwerk ohne Federhaus

Small alarms in wooden cases, movement with lantern pinions, without spring-barrel - Petit réveils en boîtes bois, mouvement avec pignons lanternes, sans barillet - Despertadores pequeña en cajas de madera, máquina con piñones de linterna, sin barrilete



8,5 x 13 cm = 3 3/4 x 5 1/4 inches

1054/264

Eiche, Chromlunette, Silberblatt, 1 Tag Weckerwerk No. 60

Oak, chromium plated bezel, silver dial, 1 day alarm movement

Chêne, lunette chromée, cadran argenté, 30 heures réveil

Roble, bisel cromado, esfera plateada, despertador, 30 horas cuerda



9 x 15 cm = 3 1/2 x 6 inches

1054/265

Eiche mit Nußbaum poliert, Chromlunette, Silberblatt, 1 Tag Weckerwerk No. 60

Oak with polished walnut, chromium plated bezel, silver dial, 1 day alarm movement

Chêne avec noyer poli, lunette chromée, cadran argenté, 30 heures réveil

Roble con nogal pulido, bisel cromado, esfera plateada, despertador, 30 horas cuerda



10 x 17,5 cm = 4 x 7 inches

1054/279

Eiche mit Nußbaum poliert, Goldlunette, Goldblatt, 1 Tag Weckerwerk No. 60

Oak with polished walnut, gilt bezel, gilt dial, 1 day alarm movement

Chêne avec noyer poli, lunette dorée, cadran doré, 30 heures réveil

Roble con nogal pulido, bisel dorado, esfera dorada, despertador, 30 horas cuerda



GRUPPE 1054

Kleine Holzwecker mit Hohltriebwerk ohne Federhaus

Small alarms in wooden cases, movement with lantern pinions, without spring-barrel - Petits réveils en boîtes bois, mouvement avec pignons lanternes, sans barillet - Despertadores pequeña en cajas de madera, máquina con piñones de linterna, sin barrilete



10x15 cm = 4x6 inches

1054/276

Eiche mit Nußbaum poliert, Chromlunette, Silberblatt, 1 Tag Weckerwerk No. 60

Oak with polished walnut, chromium plated bezel, silver dial, 1 day alarm movement

Chêne avec noyer poli, lunette chromée, cadran argenté, 30 heures réveil

Roble con nogal pulido, bisel cromado, esfera plateada, despertador, 30 horas cuerda



10x15 cm = 4x6 inches

1054/280

Eiche mit Nußbaum poliert, Goldlunette, Goldblatt, 1 Tag Weckerwerk No. 60

Oak with polished walnut, gilt bezel, gilt dial, 1 day alarm movement

Chêne avec noyer poli, lunette dorée, cadran doré, 30 heures réveil

Roble con nogal pulido, bisel dorado, esfera dorada, despertador, 30 horas cuerda



10x15 cm = 4x6 inches

1054/274

Mahagoni poliert
Polished mahogany - Acajou poli - Caoba pulida

1054/275

Kaukasisch Nußbaum poliert
Polished Caucasian walnut - Noyer Caucasiens poli
Nogal Caucaso pulido

Chromlunette, Silberblatt
1 Tag Weckerwerk No. 60

Chromium plated bezel, silver dial
1 day alarm movement

Lunette chromée, cadran argenté
30 heures réveil

Bisel cromado, esfera plateada
Despertador, 30 horas cuerda



8,5x13 cm = 3 3/4 x 5 1/4 inches

1054/266

Kaukasisch Nußbaum poliert, Chromlunette, Silberblatt, 1 Tag Weckerwerk No. 60

Polished Caucasian walnut, chromium plated bezel, silver dial, 1 day alarm movement

Noyer Caucasiens poli, lunette chromée, cadran argenté, 30 heures réveil

Nogal Caucaso pulido, bisel cromado, esfera plateada, despertador, 30 horas cuerda



GRUPPE 1005

Feine Stiluhren mit Qualitätswerk

Highclass quality boudoir clocks - Pendulettes de boudoir, qualité supérieure
Relojes para tocador de calidad superior

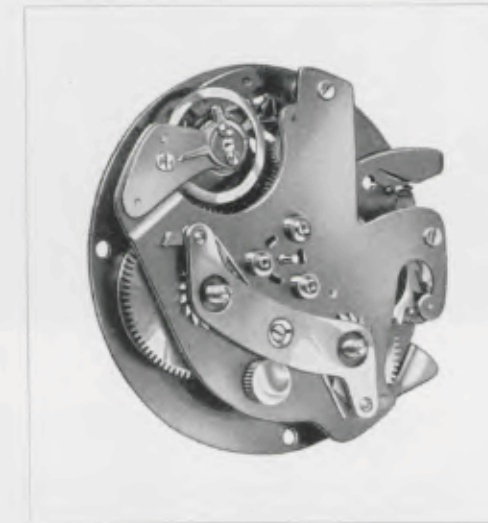

No. J 66

1 Tag flaches Weckerwerk, abnehmbare Anker- und Balancebrücke, herausnehmbare Federhäuser

1 day alarm, removable balance and lever bridges, interchangeable spring barrel

Mouvement 30 heures réveil, pont d'ancre et d'échappement démontable, barillet démontable

Despertador, 30 horas cuerda, puentes para el áncora y volante a desmontar, barrilete intercambiable

52,5 mm = 2 1/4 inches

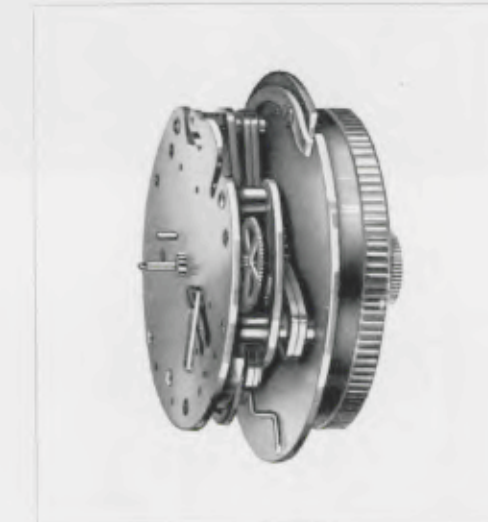

No. J 44

Gut regulierendes 8 Tag Ankergehwerk

Well regulated 8 day lever time movement

Mouvement 8 jours simple, échappement à ancre, avec bon réglage

Máquina 8 días cuerda, escape á áncora, Bien ajustada

50x42 mm = 2x1 3/4 inches



GRUPPE 1005

Feine Stiluhren mit Qualitätswerk

Highclass quality boudoir clocks - Pendulettes de boudoir, qualité supérieure
Relojes para tocador de calidad superior



7 x 10 cm = 2 7/8 x 4 inches

1005/411 RP

Verchromt poliert, zweifarbige Metallblatt mit aufgelegten Chromzahlen, Radiumpunkte und -zeiger, 1 Tag flaches Weckerwerk No. J 66

Chromium plated polished, two-coloured metal dial with chromium raised figures, luminous points and hands, 1 day alarm movement

Chromé poli, cadran métal bicolore avec chiffres chromés en relief, points et aiguilles lumineux, 30 heures réveil

Cromado pulido, esfera de metal bicolor con cifras cromadas en relieve, puntos y agujas luminosas, despertador, 30 horas cuerda



7 x 10 cm = 2 7/8 x 4 inches

1005/412 RP

Verchromt mit vergoldeter Gullochierung, zweifarbige Metallblatt mit aufgelegten Chromzahlen, Radiumpunkte und -zeiger, 1 Tag flaches Weckerwerk No. J 66

Chromium plated and gilt engine-turned, two-coloured metal dial with chromium raised figures, luminous points and hands, 1 day alarm movement

Chromé et doré avec guilloché, cadran métal bicolore avec chiffres chromés en relief, points et aiguilles lumineux, 30 heures réveil

Cromado, dorado y gravado, esfera de metal bicolor con cifras cromadas en relieve, puntos y agujas luminosas, despertador, 30 horas cuerda



7 x 10 cm = 2 7/8 x 4 inches

1005/413 RP

Vergoldet, poliert und guillochiert, zweifarbige Metallblatt mit aufgelegten Goldzahlen, Radiumpunkte und -zeiger, 1 Tag flaches Weckerwerk No. J 66

Gilt, polished and engine-turned, two-coloured metal dial with gilt raised figures, luminous points and hands, 1 day alarm movement

Doré, poli et guilloché, cadran métal bicolore avec chiffres dorés en relief, points et aiguilles lumineux, 30 heures réveil mouvement

Dorado, pulido y gravado, esfera de metal bicolor con cifras doradas en relieve, puntos y agujas luminosas, despertador, 30 horas cuerda



GRUPPE 1005

Feine Stiluhren mit Qualitätswerk

Highclass quality boudoir clocks - Pendulettes de boudoir, qualité supérieure
Relojes para tocador de calidad superior



7,5 x 9 cm = 3 x 3 1/2 inches

1005/435 RP

Verchromt, vergoldet und guillochiert, zweifarbige Metallblatt mit aufgelegten Chromzahlen, Radiumpunkte und -zeiger, 1 Tag flaches Weckerwerk No. J 66

Chromium plated, gilt and engine-turned, two-coloured metal dial with chromium raised figures, luminous points and hands, 1 day alarm movement

Chromé, doré et guilloché, cadran métal bicolore avec chiffres chromés en relief, points et aiguilles lumineux, 30 heures réveil

Cromado, dorado y gravado, esfera de metal bicolor con cifras cromadas en relieve, puntos y agujas luminosas, despertador, 30 horas cuerda

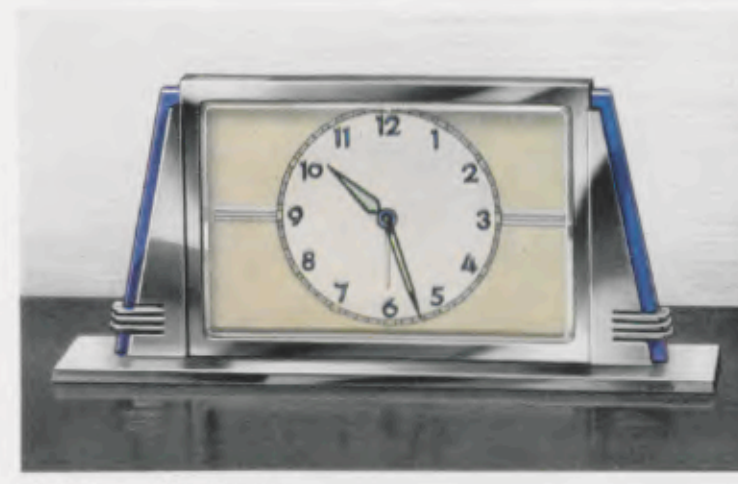

8,5 x 16,5 cm = 3 3/8 x 6 1/2 inches

1005/416 RP

1 Tag flaches Weckerwerk No. J 66 - 1 day alarm movement
30 heures réveil - Despertador, 30 horas cuerda

1005/417

8 Tag Ankergehwerk No. J 44 - 8 day lever time movement
8 jours simple à ancre - Máquina 8 días cuerda á áncora

Verchromt poliert mit blauem Kristallglas, zweifarbige Metallblatt mit aufgelegten blauen Zahlen, Radiumpunkte und -zeiger

Chromium plated polished with blue plate-glass, two-coloured metal dial with blue raised figures, luminous points and hands

Chromé poli avec verre bleu, cadran métal bicolore avec chiffres bleus en relief, points et aiguilles lumineux

Cromado pulido con cristal azul, esfera de metal bicolor con cifras azules en relieve, puntos y agujas luminosas

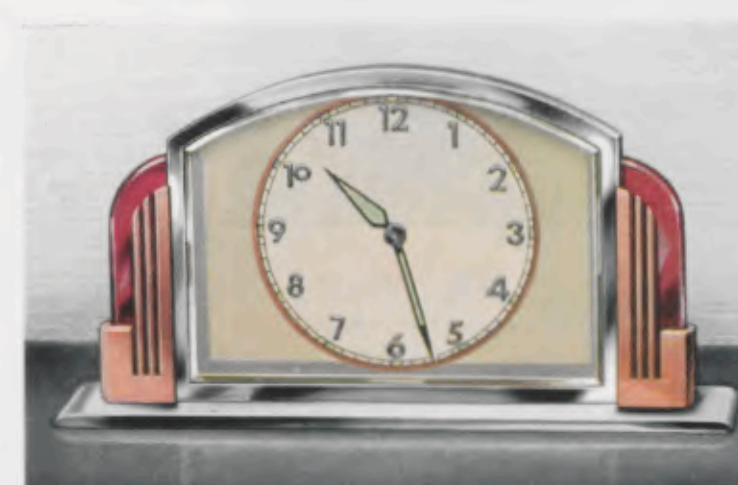

8,5 x 17,5 cm = 3 3/8 x 6 7/8 inches

1005/418 RP

1 Tag flaches Weckerwerk No. J 66 - 1 day alarm movement
30 heures réveil - Despertador, 30 horas cuerda

1005/419

8 Tag Ankergehwerk No. J 44 - 8 day lever time movement
8 jours simple à ancre - Máquina 8 días cuerda á áncora

Verchromt und verkupfert mit Kristallglas, zweifarbige Metallblatt mit aufgelegten blauen Zahlen, Radiumpunkte und -zeiger

Chromium plated and coppered with plate-glass, two-coloured metal dial with blue raised figures, luminous points and hands

Chromé et cuivré avec verre, cadran métal bicolore avec chiffres bleus en relief, points et aiguilles lumineux

Cromado y color cobre con cristal, esfera de metal bicolor con cifras azules en relieve, puntos y agujas luminosas



GRUPPE 1005

Feine Stiluhren mit Qualitätswerk

Highclass quality boudoir clocks - Pendulettes de boudoir, qualité supérieure
Relojes para tocador de calidad superior



11 x 12 cm = 4 1/4 x 4 1/4 inches

1005/425

Verchromt, mit durchsichtigem blauem Kristallglas, Goldzahlen
8 Tag Ankergehwerk No. J 44, 14 Steine

Chromium plated, with blue plate-glass, gilt figures
8 day lever time movement No. J 44, 14 jewels

Chromé, avec verre bleu, chiffres dorés
Mouvement 8 jours simple, échappement à ancre, No. J 44, 14 rubis
Cromado, con cristal azul, cifras doradas
Máquina, 8 días cuerda, escape à ancora, No. J 44, 14 rubis



13,5 x 20,5 cm = 5 1/4 x 8 inches

1005/427

Braun mit kupferfarbigem Zifferblatt, durchsichtiges Kristallglas
8 Tag Ankergehwerk No. J 44, 14 Steine

Brown with copper-coloured dial, grey plate-glass
8 day lever time movement No. J 44, 14 jewels

Brun avec cadran couleur cuivre, verre gris
Mouvement 8 jours simple, échappement à ancre, No. J 44, 14 rubis
Marron con esfera color cobre, cristal gris
Máquina 8 días cuerda, escape à ancora, No. J 44, 14 rubis



GRUPPE 1008

Wecker in Metallgehäusen

Alarm clocks in metal cases - Réveils en boîtes métal - Despertadores en cajas de metal



8,2 x 5,8 cm = 3 1/4 x 2 1/4 inches

No. 10

Großes Werk - Large movement

Grand mouvement - Máquina grande



7,1 x 5,8 cm = 2 7/8 x 2 1/4 inches

No. 231

Normalwerk, große Balance
Standard movement, large balance
Mouvement normal, grand balancier
Máquina normal, volante grande

No. 231 L

Normalwerk, große Balance, leise
tickend
Standard movement, large balance,
soft ticking
Mouvement normal, grand balancier,
à tic tac doux
Máquina normal, volante grande,
à tique-taque bajo



5,7 x 5,2 cm = 2 1/4 x 2 1/4 inches

No. 250

Kleines Werk - Small movement

Petit mouvement - Máquina pequeña

Die weltberühmten Weckerwerke - The world-renowned alarm movements
Les mouvements de réveils de réputation mondiale - Las máquinas de despertadores de fama mundial



GRUPPE 1008

Wecker in Metallgehäusen

Alarm clocks in metal cases - Réveils en boîtes métal - Despertadores en cajas de metal



Klein-Baby

15,5 cm = 6 1/8 inches

1008/265

Metallgehäuse vernickelt - Metal case nickelled
Boîte métal nickelé - Caja de metal niqueladoWeißes Kartonblatt - White cardboard dial
Cadran carton blanc - Esfera blanca de cartón1 Tag Wecker, Normalwerk - 1 day alarm, standard movement
30 heures réveil, mouvement normal - 30 horas despertador, máquina normal

Baby

18 cm = 7 inches

1008/98

Metallgehäuse vernickelt - Metal case nickelled
Boîte métal nickelé - Caja de metal niquelado

1008/234

Rotbraun - Claret coloured - Brun-rouge - Rojo oscuro

1008/235

Blau - Blue - Bleu - Azul

1 Tag Wecker, Normalwerk - 1 day alarm, standard movement
30 heures réveil, mouvement normal - 30 horas despertador, máquina normal

Stella

18 cm = 7 inches

1008/100

Metallgehäuse vernickelt - Metal case nickelled
Boîte métal nickelé - Caja de metal niquelado

1008/100 M

Messinggehäuse vernickelt - Brass case nickelled
Boîte laiton nickelé - Caja de latón niqueladoStaubdichter Regulierschlit - Dustproof regulating-slot
Fente de réglage hermétique - Hendrija de ajustamiento hermética

1008/99

Metallgehäuse vernickelt - Metal case nickelled
Boîte métal nickelé - Caja de metal niquelado1 Tag Wecker, Normalwerk - 1 day alarm, standard movement
30 heures réveil, mouvement normal - 30 horas despertador, máquina normal

Weißes Kartonblatt - White cardboard dial - Cadran carton blanc - Esfera blanca de cartón



Baby

18 cm = 7 inches

1008/242

Metallgehäuse vernickelt - Metal case nickelled
Boîte métal nickelé - Caja de metal niquelado

1008/242 M

Messinggehäuse vernickelt - Brass case nickelled
Boîte laiton nickelé - Caja de latón niquelado

Großes Werk, staubdichter Regulierschlit - Large movement, dustproof regulating-slot - Grand mouvement, fente de réglage hermétique - Máquina grande, hendrija de ajustamiento hermética

GRUPPE 1008

Wecker in Metallgehäusen

Alarm clocks in metal cases - Réveils en boîtes métal - Despertadores en cajas de metal



Tommy

18 cm = 7 inches

1008/228

Metallgehäuse vernickelt - Metal case nickelled
Boîte métal nickelé - Caja de metal niquelado1 Tag Wecker, Normalwerk - 1 day alarm, standard movement
30 heures réveil, mouvement normal
30 horas despertador, máquina normal

Globe

14 cm = 5 1/2 inches

1008/190

1 Tag Gehwerk - 1 day time movement
Mouvement 30 heures simple - 30 horas movimiento soloMetallgehäuse vernickelt - Metal case nickelled
Boîte métal nickelé - Caja de metal niquelado

Globe



16 cm = 6 1/4 inches

1008/191

Metallgehäuse vernickelt, gefalzt - Metal case nickelled, seamless
Boîte métal nickelé, plié - Caja de metal, niquelado, doblado

1008/246

Rotbraun - Claret coloured - Brun-rouge - Rojo oscuro

Glocke vernickelt - Nickelled bell
Cloche nickelée - Campana niquelada1 Tag Wecker, Normalwerk - 1 day alarm, standard movement
30 heures réveil, mouvement normal
30 horas despertador, máquina normal

Globe-Bravo



15 cm = 6 inches

1008/192

Vernickelt - Nickelled - Nickelé - Niquelado

1008/195

Rotbraun - Claret coloured - Brun-rouge - Rojo oscuro

1 Tag Wecker, Normalwerk, Schlag auf Rückwand
1 day alarm, standard movement, strike on back - 30 heures réveil, mouvement normal, sonnerie sur fond
30 horas despertador, máquina normal, tocando en el respaldo



GRUPPE 1008
Wecker in Metallgehäusen

Alarm clocks in metal cases - Réveils en boîtes métal - Despertadores en cajas de metal

Klein-Globe



12 cm = 4 3/4 inches

1008/376

Rotbraun - Claret coloured - Brun-rouge - Rojo oscuro

1008/377

Blau - Blue - Bleu - Azul

1008/379

Vernickelt, gefalzt - Nickelled, seamless
Nickelé, plié - Niquelado, doblado

Schlag auf Rückwand - Strike on back - Sonnerie sur fond - Tocando en el respaldo

Globe



13,5 cm = 5 1/4 inches

1008/276

Rotbraun - Claret coloured - Brun-rouge - Rojo oscuro

1008/277

Blau - Blue - Bleu - Azul

1008/309

Vernickelt, gefalzt - Nickelled, seamless
Nickelé, plié - Niquelado, doblado

Groß-Globe



14,5 cm = 5 3/4 inches

1008/476

Rotbraun - Claret coloured - Brun-rouge - Rojo oscuro

1008/477

Blau - Blue - Bleu - Azul

1008/479

Vernickelt - Nickelled - Nickelé - Niquelado

1 Tag Wecker, Normalwerk, Schlag auf Rückwand - 1 day alarm, standard movement, strike on back
30 heures réveil, mouvement normal, sonnerie sur fond - 30 horas despertador, máquina normal, tocando en el respaldo



10,5 cm = 4 1/4 inches

1008/594

Elfenbein, weißes Kartonblatt

Varnished ivory dull, white cardboard dial
Peinture ivoire laquée dépolie, cadran carton blanc
Barniz pulido mate, marfil, esfera blanca de cartón



GRUPPE 1008
Wecker in Metallgehäusen

Alarm clocks in metal cases - Réveils en boîtes métal - Despertadores en cajas de metal

Bravo



14,5 cm = 5 3/4 inches

1008/233

Verchromt - Chromium plated - Chromé - Cromado

1008/201

Rotbraun, mit Repetition - Claret coloured, repeating alarm - Brun-rouge, avec répétition - Rojo oscuro, con repetición

1 Tag Wecker, Normalwerk - 1 day alarm, standard movement - 30 heures réveil, mouvement normal - 30 horas despertador, máquina normal

Bravetto



12 cm = 4 3/4 inches

1008/209

Blau - Blue - Bleu - Azul

1008/211

Rotbraun - Claret coloured - Brun-rouge - Rojo oscuro

1 Tag Wecker, Normalwerk - 1 day alarm, standard movement - 30 heures réveil, mouvement normal - 30 horas despertador, máquina normal

Boxer



12 cm = 4 3/4 inches

1 Tag Wecker, Normalwerk, Rückwandglocke - 1 day alarm, standard movement, back bell - 30 heures réveil, mouvement normal, timbre fond - 30 horas despertador, máquina normal, campana en el respaldo

1008/197

Vernickelt - Nickelled - Nickelé - Niquelado

1008/198

Blau - Blue - Bleu - Azul

1008/200

Rotbraun - Claret coloured - Brun-rouge - Rojo oscuro

1008/184

Vernickelt - Nickelled - Nickelé - Niquelado

1008/185

Verchromt - Chromium plated - Chromé - Cromado

Silber- oder Kartonblatt - Silver or cardboard dial - Cadran argenté ou carton - Esfera plateada ó de cartón

1008/213

Vernickelt - Nickelled - Nickelé - Niquelado

1008/307

Vernickelt, mit Repetition - Nickelled, repeating alarm - Nickelé, avec répétition - Niquelado, con repetición



GRUPPE 1008
Wecker in Metallgehäusen

Alarm clocks in metal cases - Réveils en boîtes métal - Despertadores en cajas de metal

Neu-Bravetto



10,5 cm = 4 1/4 inches

1008/373

Rotbraun - Claret coloured - Brun-rouge - Rojo oscuro

1008/474

Rotbraun, mit Repetition - Claret coloured, repeating alarm - Brun-rouge, avec répétition - Rojo oscuro, con repetición

Weißes Kartonblatt - White cardboard dial
Cadran carton blanc - Esfera blanca de cartón

Neu-Bravetto



10,5 cm = 4 1/4 inches

1008/374

Verchromt mit blauem Band
Chromium plated with blue centre-band
Chromé avec bande émaillée bleue
Cromado con cinta esmaltada azul

Silberblatt - Silver dial - Cadran argenté
Esfera plateada



10,5 cm = 4 1/4 inches

1008/560

Elfenbeinartig, weißes Kartonblatt
Varnished ivory dull, white cardboard dial
Peinture ivoire laquée dépolie, cadran carton blanc
Barnis pulido mate, marfil, esfera blanca de cartón

1 Tag Wecker, Normalwerk - 1 day alarm, standard movement
30 heures réveil, mouvement normal - 30 horas despertador, máquina normal



10,5 cm = 4 1/4 inches

1008/700

Vernickelt mit blauem Band und Rückwand, Kartonblatt - Nickelled with blue centre-band and back-case, cardboard dial - Nickelé avec ruban et fond bleu, cadran carton - Niquelado con cinta y respaldo azul, esfera de cartón



GRUPPE 1008
Wecker in Metallgehäusen

Alarm clocks in metal cases - Réveils en boîtes métal - Despertadores en cajas de metal



10,5 cm = 4 1/4 inches

1008/702 RP

Vernickelt mit blauem Band und blauer Rückwand, Metallblatt mit Relieffzahlen, Radiumpunkte und -zeiger

Nickelled with blue centre-band and back-case, metal dial with raised figures, luminous points and hands

Nickelé avec ruban et fond bleu, cadran métal avec chiffres relief, points et aiguilles lumineux

Niquelado con cinta y respaldo azul, esfera de metal con cifras en relieve, puntos y agujas luminosos

1 Tag Wecker, Normalwerk - 1 day alarm, standard movement
30 heures réveil, mouvement normal - 30 horas despertador, máquina normal

Pionier I



14,5 cm = 5 3/4 inches

1008/207

Vernickelt - Nickelled - Nickelé - Niquelado

1 Tag Wecker, Normalwerk, Rückwandglocke - 1 day alarm, standard movement, back bell - 30 heures réveil, mouvement normal, timbre fond - 30 horas despertador, máquina normal, campana en el respaldo

Pionier II



15,5 cm = 6 inches

1008/208

Metallgehäuse vernickelt - Metal case nickelled
Boîte métal nickelé - Caja de metal niquelado

1 Tag Wecker, Normalwerk, Rückwandglocke, abstellbare Repetition - 1 day alarm, standard movement, back bell, with both continuous and repeating alarm at option - 30 heures réveil, mouvement normal, timbre fond, répétition à volonté - 30 horas despertador, máquina normal, campana en el respaldo, repetición á voluntad



GRUPPE 1008

Wecker in Metallgehäusen

Alarm clocks in metal cases - Réveils en boîtes métal - Despertadores en cajas de metal

Lloyd II



17 cm - 6 3/4 inches

1008/227

Metallgehäuse vernickelt - Metal case nickelled
Boîte métal niquelée - Caja de metal niquelado

Lloyd III



17 cm - 6 3/4 inches

1008/439

Metallgehäuse vernickelt - Metal case nickelled
Boîte métal niquelée - Caja de metal niquelado

1 Tag Wecker, Normalwerk, Rückwandglocke, abstellbare Repetition

1 day alarm, standard movement, back bell, with both continuous and repeating alarm at option
30 heures réveil, mouvement normal, timbre fond, répétition à volonté

30 horas despertador, máquina normal, campana en el respaldo, repetición a voluntad

Luxor-Repetition



16 cm - 6 1/4 inches

1008/571

Chromgehäuse mit rotem Band - Chrome case with red centre band - Boîte métal chromée avec bande rouge
Caja de metal cromada con cinta roja

1008/572

Chromgehäuse mit blauem Band - Chrome case with blue centre band - Boîte métal chromée avec bande bleue - Caja de metal cromada con cinta azul

Zweifarbigen Metallblatt mit Radium, 1 Tag Repetierwecker auf Rückwandglocke. - Two-coloured metal dial with Radium, 1 day repeat alarm on back bell
Cadran métal bicolor avec Radium, 30 heures réveil à répétition sur timbre fond - Esfera de metal bicolor con Radium, 30 horas despertador con repetición sobre campana en el respaldo

Lloyd IV



18 cm - 7 inches

1008/364

Metallgehäuse vernickelt - Metal case nickelled
Boîte métal niquelée - Caja de metal niquelado

1 Tag Wecker, großes Werk, Rückwandglocke, abstellbare Repetition

1 day alarm, large movement, back bell, with both continuous and repeating alarm at option

30 heures réveil, grand mouvement, timbre fond, répétition à volonté

30 horas despertador, máquina grande, campana en el respaldo, repetición a voluntad



GRUPPE 1008

„Silent-tic“, der leise tickende Wecker mit Vorabsteller

The alarm with soft tick - Le réveil à tic-tac doux - El despertador a tique-taque bajo



14,5 cm - 5 3/4 inches

1008/410

Vernickelt - Nickelled - Niquelée - Niquelado

1008/411

Rothbraun - Claret coloured - Brun-rouge - Rojo oscuro

Weißes Kartonblatt - White cardboard dial - Cadran carton blanc - Esfera blanca de cartón



11,5 cm - 4 1/2 inches

1008/703

Metallgehäuse rothbraun, Kartonblatt

Claret coloured metal case, cardboard dial

Boîte métal brun-rouge, cadran carton

Caja de metal rojo-oscuro, esfera de cartón

1 Tag Weckerwerk No. 231 L - 1 day alarm movement No. 231 L

30 heures réveil mouvement No. 231 L - Despertador, 30 horas cuerda, No. 231 L



10,5 cm - 4 1/8 inches

1008/705

Metallgehäuse elfenbeinfarbig, Metallblatt

Ivory colour metal case, metal dial

Boîte métal beige, cadran métal

Caja de metal color marfil, esfera de metal



GRUPPE 1008

„Silent-tic“, der leise tickende Wecker mit Vorabsteller
The alarm with soft tick - Le réveil à tic-tac doux - El despertador à tique-taque bajo



10,5 cm = 4 1/8 inches

1008/381

Rotbraun, weißes Kartonblatt - Claret coloured, white cardboard dial - Brun-rouge, cadran carton blanc - Rojo oscuro, esfera blanca de cartón



10,5 cm = 4 1/8 inches

1008/385

Verchromt mit blauem Band, Silberblatt - Chromium plated with blue centre-band, silver dial - Chromé avec ruban bleu, cadran argenté - Cromado con cinta azul, esfera plateada



10,5 cm = 4 1/8 inches

1008/391

Verchromt mit schwarzem Band, Silberblatt - Chromium plated with black centre-band, silver dial - Chromé avec ruban noir, cadran argenté - Cromado con cinta negra, esfera plateada



10,5 cm = 4 1/8 inches

1008/713 RP

Metallgehäuse vergoldet mit braunem Band, Metallblatt mit Relieffahlen, Radiumpunkte und -zeiger
Gilt metal case with brown centre-band, metal dial with raised figures, luminous points and hands - Boîte métal doré avec ruban brun, cadran métal avec chiffres relief, points et aiguilles lumineux - Caja de metal dorado con cinta marron, esfera de metal con cifras en relieve, puntos y agujas luminosos

1 Tag Weckerwerk No. 231 L - 1 day alarm movement No. 231 L
30 heures réveil mouvement No. 231 L - Despertador, 30 horas cuerda, No. 231 L



GRUPPE 1008

Wecker in Metallgehäusen

Alarm clocks in metal cases - Réveils en boîtes métal - Despertadores en cajas de metal



1 Tag Wecker - 1 day alarm - 30 heures réveil - 30 horas despertador

Kleinwerk No. 250 - Small movement
Avec le petit mouvement - Con máquina pequeña

Bravettino



9,5 cm = 3 3/4 inches

1008/1030

Metallgehäuse rotbraun - Claret coloured metal case - Boîte métal brun-rouge
Caja de metal rojo oscuro

Weißes Kartonblatt - White cardboard dial - Cadran carton blanc - Esfera blanca de cartón

Bravettino



9,5 cm = 3 3/4 inches

1008/1031

Metallgehäuse verchromt mit blau emailliertem Band - Chromium plated metal case with blue enameled centre-band - Boîte métal chromé avec bande émaillée bleue - Caja de metal cromado con cinta esmaltada azul

Metallblatt - Metal dial - Cadran métal
Esfera de metal

Bravettino



9,5 cm = 3 3/4 inches

1008/1032

Metallgehäuse verchromt, mit elfenbeinfarbigem Band, bombiertes Glas
Chromium plated metal case with centre-band, varnished ivory dull, convex glass
Boîte métal chromé avec bande peinture ivoire laquée dépolie, verre bombé
Caja de metal cromado con cinta barnis pulido mate, marfil, cristal biselado

Metallblatt mit verchromten Zahlen, Radiumpunkte und -zeiger
Metal dial with chromium plated figures, luminous points and hands
Cadran métal avec chiffres chromés, points et aiguilles chromés
Esfera de metal con cifras cromadas, puntos y agujas luminosos

1 Tag Wecker, Kleinwerk No. 250 - 1 day alarm, small movement
30 heures réveil avec petit mouvement - 30 horas despertador con máquina pequeña



GRUPPE 1008

Wecker in Metallgehäusen

Alarm clocks in metal cases - Réveils en boîtes métal - Despertadores en cajas de metal



Globe

16 cm = 6 1/4 inches

1008/1000

Metallgehäuse vernickelt - Metal case nickelled
Boîte métal nickelé - Caja de metal niquelado

1008/1001

Rotbraun - Claret coloured - Brun rouge - Rojo oscuro
Glocke vernickelt - Nickelled bell
Cloche nickelé - Campana niquelada



Klein-Baby

15,5 cm = 6 1/4 inches

1008/1025

Metallgehäuse vernickelt - Metal case nickelled
Boîte métal nickelé - Caja de metal niquelado

Weißes Kartonblatt - White cardboard dial
Cadran carton blanc - Esfera blanca de cartón



Baby

18 cm = 7 inches

1008/1003

Metallgehäuse vernickelt - Metal case nickelled
Boîte métal nickelé - Caja de metal niquelado

1008/1004

Rotbraun - Claret coloured - Brun-rouge - Rojo oscuro

Staubdichter Regulierrschlitz - Dustproof regulating-slot
Fente de réglage hermétique - Hendrija de ajustamiento hermética

1008/1007

Metallgehäuse vernickelt - Metal case nickelled
Boîte métal nickelé - Caja de metal niquelado

1 Tag Wecker, Kleinwerk No. 250 - 1 day alarm, small movement
30 heures réveil avec petit mouvement - 30 horas despertador con máquina pequeña



Tommy

18 cm = 7 inches

1008/1008

Metallgehäuse vernickelt - Metal case nickelled
Boîte métal nickelé - Caja de metal niquelado



GRUPPE 1008

Wecker in Metallgehäusen

Alarm clocks in metal cases - Réveils en boîtes métal - Despertadores en cajas de metal



Bravetto

12 cm = 4 3/4 inches

1008/1016

Rotbraun - Claret coloured - Brun-rouge - Rojo oscuro

1008/1026

Vernickelt - Nickelled - Nickelé - Niquelado



Kleinst-Globe

11 cm = 4 3/8 inches

1008/1076

Rotbraun - Claret coloured - Brun-rouge - Rojo oscuro

1008/1077

Blau - Blue - Bleu - Azul

1008/1079

Vernickelt, gefalzt - Nickelled, seamless
Nickelé, plié - Niquelado, doblado



Klein-Globe

12 cm = 4 3/4 inches

1008/1021

Rotbraun - Claret coloured - Brun-rouge - Rojo oscuro

1008/1022

Blau - Blue - Bleu - Azul

1008/1024

Vernickelt, gefalzt - Nickelled, seamless
Nickelé, plié - Niquelado, doblado

1 Tag Wecker, Kleinwerk No. 250 - 1 day alarm, small movement
30 heures réveil avec petit mouvement - 30 horas despertador con máquina pequeña

Globe



13,5 cm = 5 1/4 inches

1008/1009

Rotbraun - Claret coloured - Brun-rouge - Rojo oscuro

1008/1010

Blau - Blue - Bleu - Azul

1008/1012

Vernickelt, gefalzt - Nickelled, seamless
Nickelé, plié - Niquelado, doblado



GRUPPE 1008

Wecker in Metallgehäusen

Alarm clocks in metal cases - Réveils en boîtes métal - Despertadores en cajas de metal



15 cm = 6 inches

1008/1039

Vernickelt, gefalzt - Nickelied, seamless
Nickelé, plié - Niquelado, doblado

1008/1040

Rothbraun - Claret coloured - Brun-rouge - Rojo oscuro



14,5 cm = 5 7/8 inches

1008/1017

Rotbraun - Claret coloured - Brun-rouge - Rojo oscuro

1008/1018

Vernickelt - Nickelied - Nickelé - Niquelado

1008/1019

Blaue - Blue - Bleu - Azul



11 cm = 4 1/4 inches

1008/1046

Metallgehäuse rothbraun - Claret coloured metal case
Boîte métal brun-rouge - Caja de metal rojo oscuro

Weißes Kartonblatt - White cardboard dial
Cadran carton blanc - Esfera blanca de cartón

1 Tag Wecker, Schlag auf Rückwand, Kleinwerk No. 250 - 1 day alarm, strike on back, small movement
30 heures réveil, sonnerie sur fond, avec petit mouvement - 30 horas despertador, tocando en el respaldo, con máquina pequeña



11 cm = 4 1/4 inches

1008/1042

Metallgehäuse vernickelt mit blau emailliertem Band
Nickelied metal case with blue enamelled centre-band
Boîte métal nickelée avec bande émaillée bleue
Caja de metal niquelado con cinta esmaltada azul

Weißes Kartonblatt - White cardboard dial
Cadran carton blanc - Esfera blanca de cartón



GRUPPE 1008

Wecker in Metallgehäusen

Alarm clocks in metal cases - Réveils en boîtes métal - Despertadores en cajas de metal



11,5 cm = 4 1/2 inches

1008/1086

Vernickelt mit blauem Band
Nickelied with blue centre-band

Nickelé avec ruban bleu
Niquelado con cinta azul



11,5 cm = 4 1/2 inches

1008/1087

Vernickelt mit rotem Band
Nickelied with red centre-band

Nickelé avec ruban rouge
Niquelado con cinta roja



11,5 cm = 4 1/2 inches

1008/1089

Vernickelt mit elfenbeinfarbigem Band
Nickelied with centre-band, varnished ivory dull

Nickelé avec ruban peinture ivoire
laquée dépolie
Niquelado con cinta barniz pulido
mate

1 Tag Wecker, Kleinwerk No. 250 - 1 day alarm, small movement
30 heures réveil avec petit mouvement - 30 horas despertador con máquina pequeña



GRUPPE 1008

Wecker in Metallgehäusen

Alarm clocks in metal cases - Réveils en boîtes métal - Despertadores en cajas de metal



1008/1095 RP

Vergoldet mit grünem Band, Metallblatt mit Reliefzahlen, Radiumpunkte und -zeiger

Gilt with green centre-band, metal dial with raised figures luminous points and hands

9,5 cm = 3 3/4 inches

Doré avec bande verte, cadran métal avec chiffres relief, points et aiguilles lumineux

Dorado con cinta verde, esfera de metal con cifras en relieve, puntos y agujas luminosos



1008/1097

Rotbraun - Claret coloured Brun-rouge - Rojo oscuro

1008/1098

Blau - Blue - Bleu - Azul

12,5 cm = 5 inches

1008/1099

Vernickelt - Nickelled - Nickelé Niquelado

1008/1100

Verchromt - Chromium plated Chromé - Cromado

Kartonblatt - Cardboard dial Cadran carton - Esfera de cartón

1 Tag Wecker, Kleinwerk No. 250 - 1 day alarm, small movement

30 heures réveil avec petit mouvement - 30 horas despertador con máquina pequeña



GRUPPE 1008

Wecker in Metallgehäusen

Alarm clocks in metal cases - Réveils en boîtes métal - Despertadores en cajas de metal

Joker I



19 cm = 7 inches

Stahlgehäuse - Steel cases - Boîtes acier - Cajas de acero

1008/9

1 Tag Wecker - 1 day alarm - 30 heures réveil - 30 horas despertador

1008/15

1 Tag Schlagwerk - 1 day strike - 30 heures sonnerie - 30 horas soneria

1008/16

1 Tag Schlagwerk und Wecker - 1 day strike and alarm 30 heures sonnerie et réveil - 30 horas sonería y despertador

1008/17

1 Tag Musikwecker, 1 Arie - 1 day musical alarm, 1 air 30 heures réveil musique, 1 air - 30 horas despertador de música, 1 pieza

1008/18

1 Tag Musikwecker, 2 Arien - 1 day musical alarm, 2 airs 30 heures réveil musique, 2 airs - 30 horas despertador de música, 2 piezas

1008/19

1 Tag Musikschlagwerk, 1 Arie - 1 day musical strike, 1 air 30 heures sonnerie musique, 1 air - 30 horas sonería á música, 1 pieza



GRUPPE 1009

Wecker in Holzgehäusen

Alarm clocks in wooden cases - Réveils en cages bois - Despertadores en cajas de madera

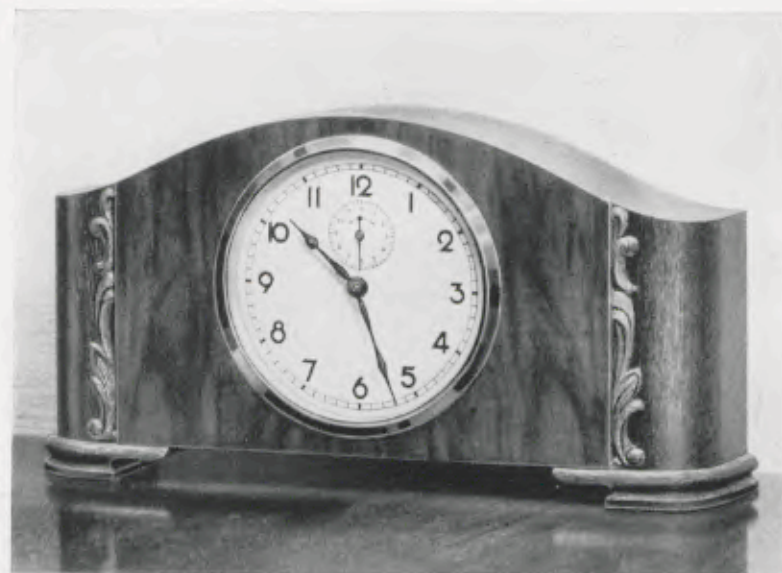

14 x 27 cm = 5 1/2 x 10 3/4 inches

1009/159

Eiche mit polierter Nussbaumfront, Chromlunette, Elfenbeinblatt, 1 Tag Weckerwerk No. 231

Oak with polished walnut, chromium plated bezel, beige dial, 1 day alarm
Chêne avec noyer poli, lunette chromée, cadran beige, 30 heures réveil
Roble con nogal pulido, bisel cromado, esfera color marfil, 30 horas despertador

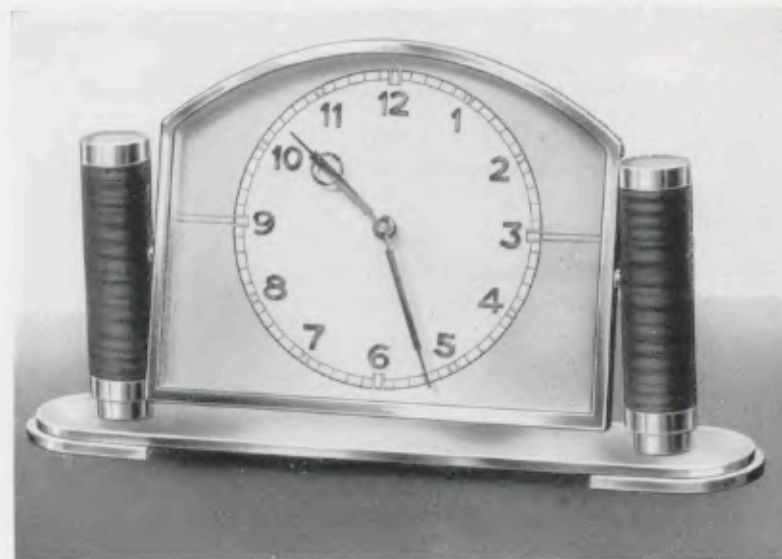

17.5 x 31 cm = 7 x 12 1/2 inches

1009/144

Chrom mi (Nussbaumsäulen, Silberblatt mit aufgelegten Chromzahlen, 1 Tag Weckerwerk No. 231

Chrome with polished walnut pillars, silver dial with raised chrome figures, 1 day alarm
Chromé avec piliers en noyer poli, cadran argenté avec chiffres appliqués chromés, 30 heures réveil
Cromado con nogal pulido, esfera plateada con cifras aplicadas cromadas, 30 horas despertador



GRUPPE 1010

Schreibtischuhren

Writing table clocks - Pendulettes de bureau - Relojes para escritorio

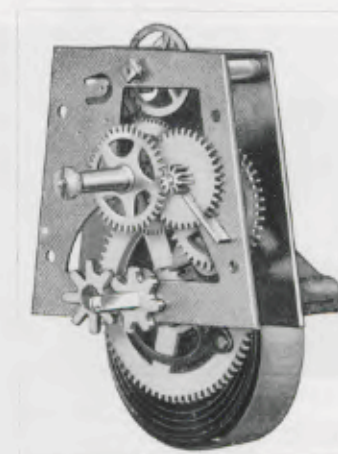

Platinen - Plates - Platines - Platinas
5.5 x 5 cm = 2 1/4 x 2 inches

No. 239

8 Tag Ankergehwerk - 8 day lever time movement
Mouvement 8 jours simple à ancre - Máquina 8 días cuerdas a ancora



14 x 27 cm = 5 1/2 x 10 3/4 inches

1010/100

Eiche mit polierter Nussbaumfront, Chromlunette, Silberblatt

Oak with polished walnut, chromium plated bezel, silver dial
Chêne avec noyer poli, lunette chromée, cadran argenté
Roble con nogal pulido, bisel cromado, esfera plateada



16 x 22 cm = 6 1/4 x 11 inches

1010/106

Nussbaum poliert, 13 cm Goldlunette, zweifarbiger Zahlenreiß

Polished walnut, gilt bezel, 5 inches, two-coloured figure-circle
Noyer poli, lunette dorée, 13 cm, cercle à chiffres bicolores
Nogal pulido, bisel dorado, 13 cm, cerco de cifras bicolor

1036/10/106

Synchrongehwerk - Synchronous movement
Mouvement Synchron - Máquina Sincron

8 Tag Ankergehwerk - 8 day lever time movement
8 jours simple, échappement à ancre - Máquina 8 días cuerdas, escape à ancora



GRUPPE 1010

Schreibtischuhren

Writing table clocks - Pendulettes de bureau - Relojes para escritorio



14 x 17,5 cm = 5 1/2 x 7 inches

1010/102

Nußbaum poliert, 11 x 11 cm Chromlünette, Metallblatt

Polished walnut, chromium plated bezel, 4 1/4 x 4 1/4 inches, metal dial

Noyer poli, lunette chromée, 11 x 11 cm, cadran argenté

Nogal pulido, bisel cromado, 11 x 11 cm, esfera plateada

1036/10/102

Synchrongehwerk - Synchronous movement
Mouvement Synchron - Máquina Sincron

17,5 x 31 cm = 7 x 12 1/2 inches

1010/94

Chrom mit Nußbaumsäulen, Silberblatt mit aufgelegten Chromzahlen

Chrome with polished walnut pillars, silver dial with raised chrome figures

Chromé avec piliers en noyer poli, cadran argenté avec chiffres appliqués chromés

Cromado con nogal pulido, esfera plateada con cifras aplicadas cromadas

1036/10/94

Synchrongehwerk - Synchronous movement
Mouvement Synchron - Máquina Sincron8 Tag Ankergehwerk No. 239 - 8 day lever time movement
8 jours simple, échappement à ancre - Máquina 8 días cuerda, escape à âncora

GRUPPE 1017

Tischuhren

Mantle Clocks - Pendules de cheminée - Relojes de sobremesa

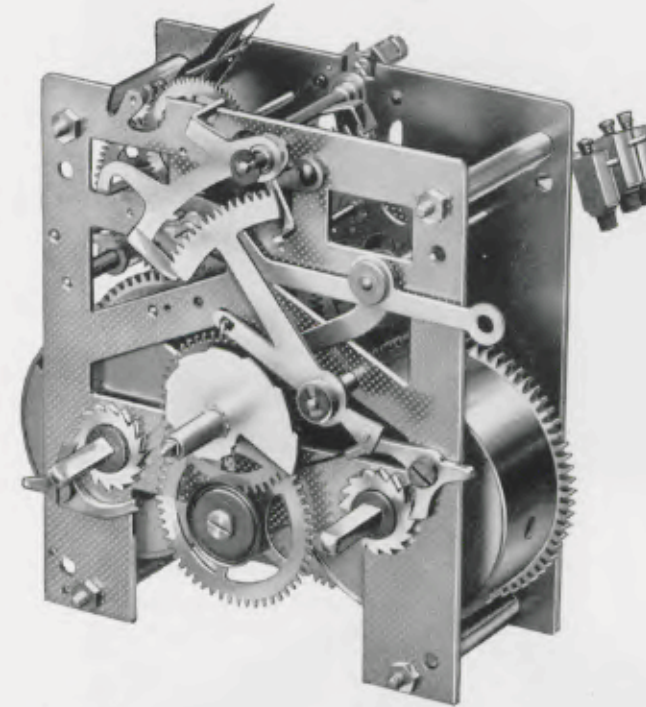

No. 278

14 Tag Halbstund-Rechenschlagwerk auf Rundgong oder Bim Bam 3 Stäbe, herausnehmbare Federhäuser

14 day half-hour rack-strike movement on Gong or Gong „Bim Bam“: 3 rods, interchangeable spring barrels

Mouvement à râteau 15 jours sonnerie heures et demies sur Gong rond ou Gong „Bim Bam“: 3 tiges, barilets interchangeables

Máquina á sierra 15 días sonería horas y medias sobre Gong redondo ó Gong „Bim Bam“: 3 varillas, barriletes intercambiables

No. 278

14 Tag Halbstund-Rechenschlagwerk auf Bügelgong D.R.G.M. Bim Bam 5 Stäbe, herausnehmbare Federhäuser

14 day half-hour rack-strike movement on Suspension-Gong D.R.G.M. Gong „Bim Bam“: 5 rods, interchangeable spring barrels

Mouvement à râteau 15 jours sonnerie heures et demies sur Gong suspension „Bim Bam“: 5 tiges, barilets interchangeables

Máquina á sierra 15 días sonería horas y medias sobre Gong suspensión D.R.G.M. Gong „Bim Bam“: 5 varillas, barriletes intercambiables

No. 278

Platinen - Plates - Platines - Platinas 11 x 9,5 cm = 4 1/4 x 3 3/4 inches

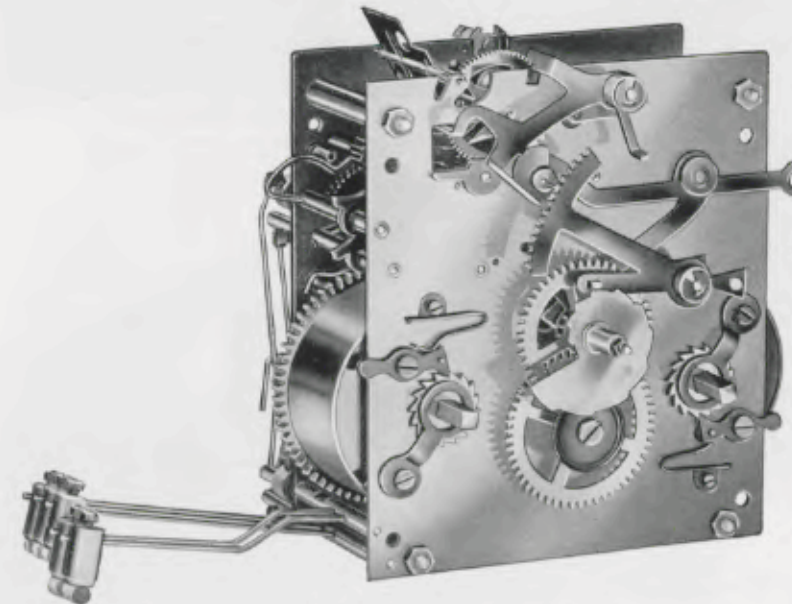

No. 276

14 Tag Halbstund-Rechenschlagwerk auf Bügelgong D.R.G.M. Bim Bam 5 Stäbe. Massive Triebe. Polierte Vollplatinen, Grahamgang

14 day half-hour rack-strike movement on Suspension Gong D.R.G.M. Gong „Bim Bam“: 5 rods. Solid pinions. Polished full plates. Graham escapement

Mouvement à râteau 15 jours sonnerie heures et demies sur Gong suspension „Bim Bam“: 5 tiges D.R.G.M. Pignons massifs. Platines polies. Echappement Graham

Máquina á sierra 15 días sonería horas y medias sobre Gong suspensión „Bim Bam“: 5 varillas D.R.G.M. Piñones macizos. Platinas pulidas. Ancora sistema Graham

No. 276 Platinen - Plates - Platines - Platinas 11 x 9,5 cm = 4 1/4 x 3 3/4 inches



GRUPPE 1017

Tischuhren

Mantle Clocks - Pendules de cheminée - Relojes de sobremesa

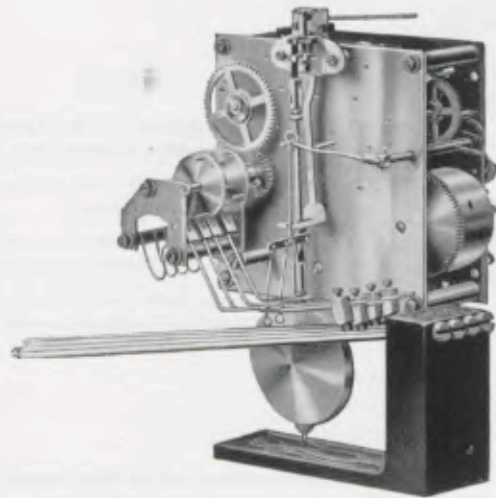

Platinen - Plates - Platines - Platinas
10,5 x 10,5 cm = 4 1/8 x 4 1/8 inches

Kleines Werk No. 200

8 Tag 1/4 Westminsterschlag, massive Triebe
8 day 1/4 Westminister chime, solid pinions
8 jours 1/4 Carillon Westminster, pignons massifs
8 dias 1/4 Carillon Westminster, piñones macizos

Großes Werk No. 64

8 Tag 1/4 Westminister-Schlagwerk mit
massiven Trieben, auswechselbare
Federhäuser

8 day 1/4 Westminister chime movement with solid
pinions, interchangeable spring barrels
8 jours mouvement 1/4 Carillon Westminster avec
pignons massifs, barillets interchangeables
Máquina 8 dias 1/4 Carillon Westminster con
piñones macizos, barriletes intercambiables

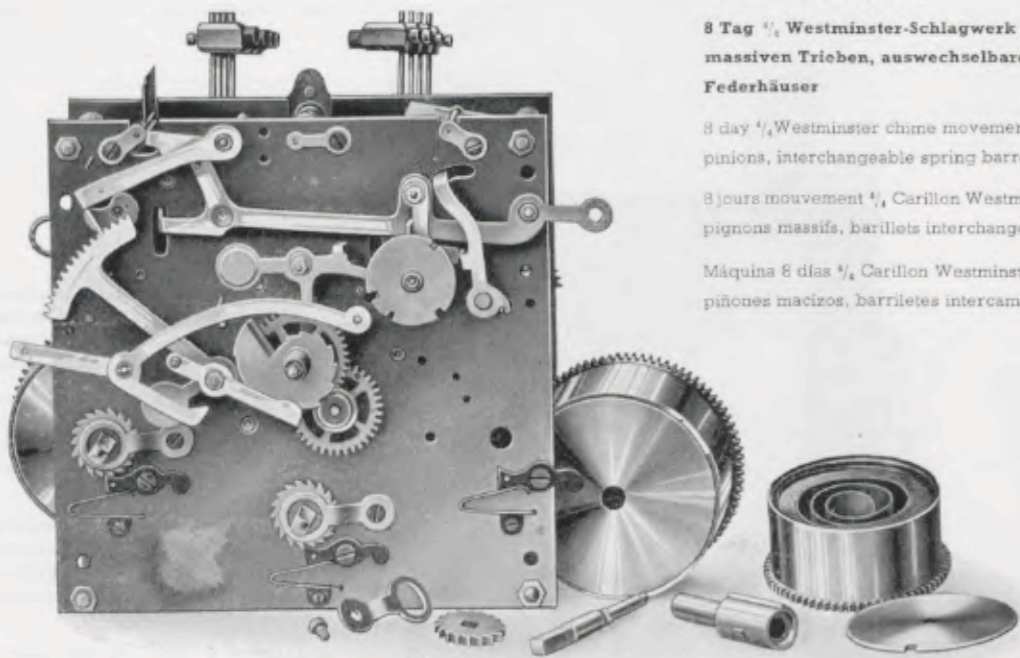

Platinen - Plates - Platines - Platinas 12,3 x 12,3 cm = 4 7/8 x 4 7/8 inches



GRUPPE 1017

Tischuhren

Mantle Clocks - Pendules de cheminée - Relojes de sobremesa

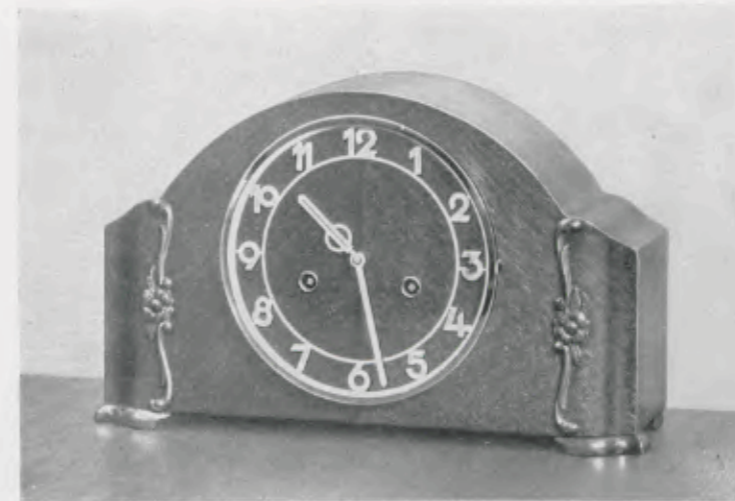

20,5 x 33 cm = 8 x 13 inches

1017/956

Eiche, 17 cm Chromlunette, matt ver-
silberter Zahlenreif, Gong - Bim Bam
3 Stäbe - 1/4 Westminsterschlag Werk 200

Oak, chromium plated bezel, 6 3/4 inches,
dull silvered figure-circle, Gong - Gong
„Bim Bam“: 3 rods - 1/4 Westminister chime

Chêne, lunette chromée, 17 cm, cercle à
chiffres argenté mat, Gong rond - Gong
„Bim Bam“: 3 tiges - 1/4 Carillon Westminster

Roble, bisel cromado, 17 cm, cerco de cifras
plateado mate, Gong redondo - Gong „Bim
Bam“: 3 varillas - 1/4 Carillon Westminster

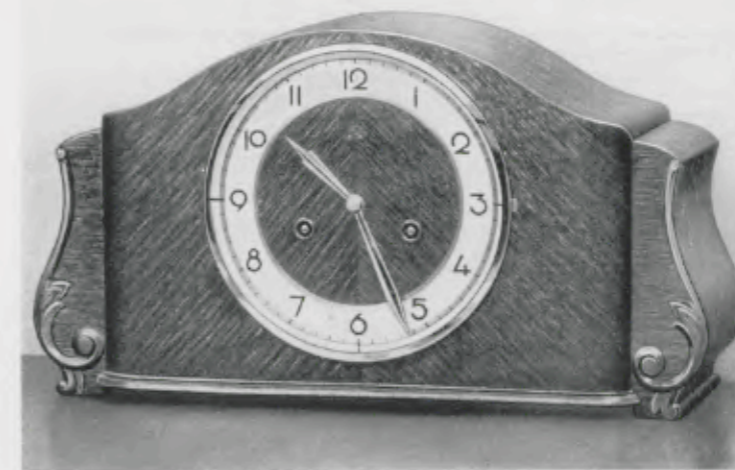

21,5 x 40 cm = 8 1/2 x 15 3/4 inches

1017/1275

Eiche, 18 cm Goldlunette, zweifarbiger
Zahlenreif, Rundgong - Bim Bam 3 Stäbe -
1/4 Westminsterschlag Werk 200

Oak, gilt bezel, 7 inches, two-coloured
figure-circle, Gong - Gong „Bim Bam“:
3 rods - 1/4 Westminister chime

Chêne, lunette dorée, 18 cm, cercle à
chiffres bicolore, Gong rond - Gong „Bim
Bam“: 3 tiges - 1/4 Carillon Westminster

Roble, bisel dorado, 18 cm, cerco de cifras
bicolor, Gong redondo - Gong „Bim Bam“:
3 varillas - 1/4 Carillon Westminster

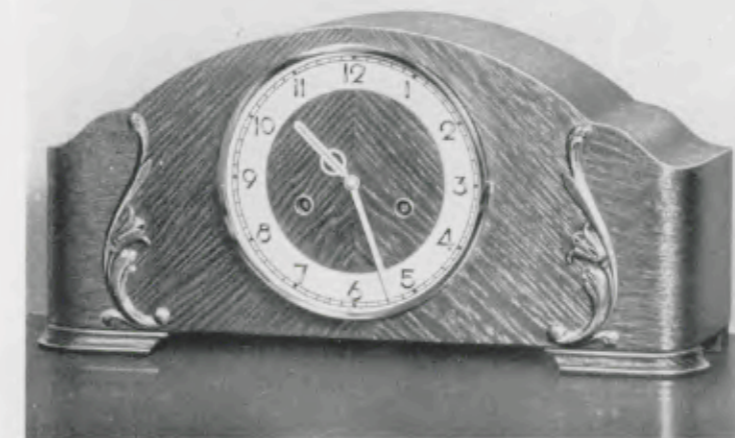

20,5 x 41 cm = 8 x 16 1/4 inches

1017/991

Eiche, 17 cm Chromlunette, Silberzahlen-
reif mit erhabenen polierten Zahlen,
Rundgong - Bim Bam 3 Stäbe - 1/4 West-
minsterschlag Werk 200

Oak, chromium plated bezel, 6 3/4 inches,
silvered figure-circle with polished raised
figures, Gong - Gong „Bim Bam“: 3 rods -
1/4 Westminister chime

Chêne, lunette chromée, 17 cm, cercle à
chiffres argenté avec chiffres polis en relief,
Gong rond - Gong „Bim Bam“: 3 tiges -
1/4 Carillon Westminster

Roble, bisel cromado, 17 cm, cerco de cifras
plateado con cifras pulidas en relieve, Gong
redondo - Gong „Bim Bam“: 3 varillas -
1/4 Carillon Westminster



GRUPPE 1017

Tischuhren

Mantle Clocks - Pendules de cheminée - Relojes de sobremesa

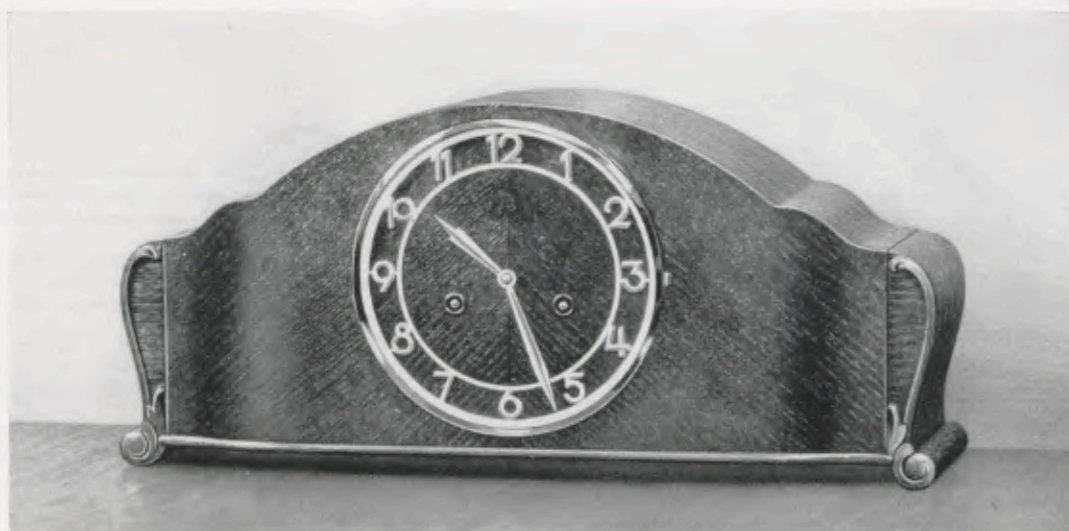

21,5 x 46 cm = 8 1/2 x 18 1/4 inches

1017/1257

Eiche, 18 cm Chromlunette, versilberter Zahlenreif mit gewölbten Zahlen, Gong - Bim Bam 5 Stäbe, Gongabsteller, 1/4 Westminsterschlag Werk 64

Oak, chromium plated bezel, 7 inches, dull silvered figure-circle with embossed figures, Gong - Gong „Bim Bam“: 5 rods, gong-stopper - 1/4 Westminister chime

Chêne, lunette chromée, 18 cm, cercle à chiffres argenté mat avec chiffres voûtés, Gong rond - Gong „Bim Bam“: 5 tiges, avec dispositif d'arrêt de la sonnerie - 1/4 Carillon Westminster

Roble, bisel cromado, 18 cm, cerco de cifras plateado mate con cifras encorvadas, Gong redondo - Gong „Bim Bam“: 5 varillas, con parasonidos - 1/4 Carillon Westminster

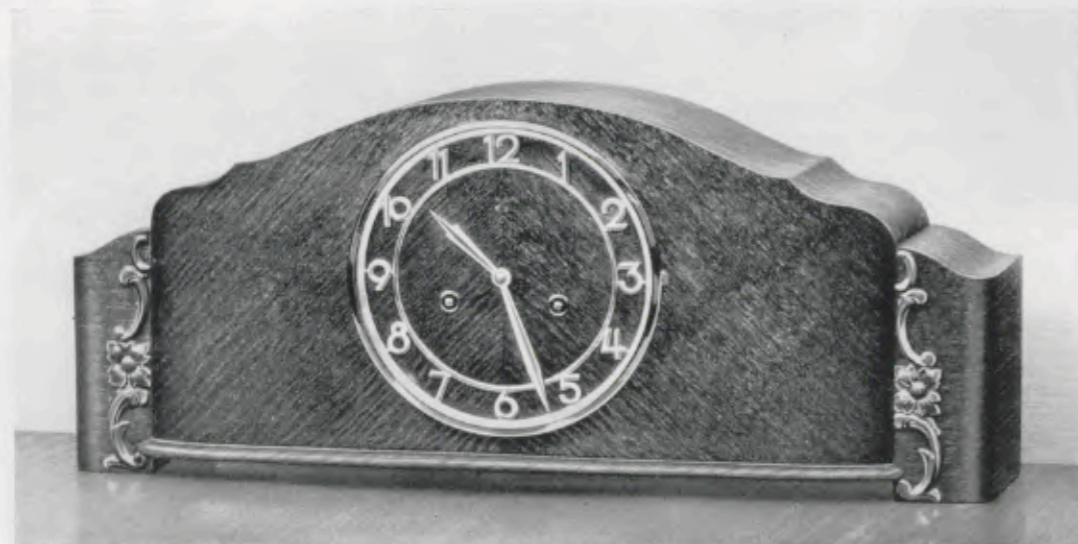

22 x 55 cm = 8 3/4 x 21 3/4 inches

1017/1276

Eiche, 18 cm Chromlunette, Silberzahlenreif mit gewölbten Zahlen, Gong - Bim Bam 5 Stäbe, Gongabsteller, 1/4 Westminsterschlag Werk 64

Oak, chromium plated bezel, 7 inches, silvered figure-circle with embossed figures, Gong - Gong „Bim Bam“: 5 rods, gong-stopper - 1/4 Westminister chime

Chêne, lunette chromée, 18 cm, cercle à chiffres argenté avec chiffres voûtés, Gong rond - Gong „Bim Bam“: 5 tiges, avec dispositif d'arrêt de la sonnerie - 1/4 Carillon Westminster

Roble, bisel cromado, 18 cm, cerco de cifras plateado con cifras encorvadas, Gong redondo - Gong „Bim Bam“: 5 varillas, con parasonidos - 1/4 Carillon Westminster



GRUPPE 1017

Tischuhren

Mantle Clocks - Pendules de cheminée - Relojes de sobremesa

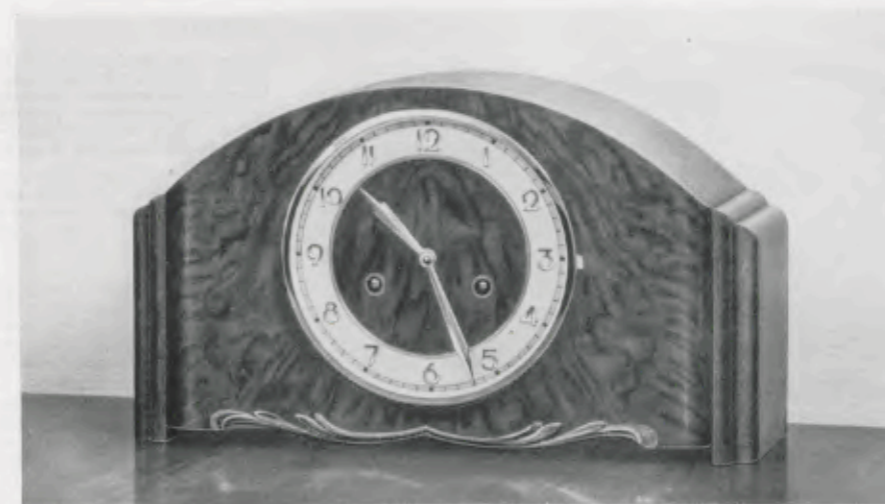

20,5 x 36 cm = 8 x 14 1/2 inches

1017/1245

Eiche mit kaukasisch Nußbaum poliert, 17 cm Goldlunette, zweifarbiger Zahlenreif mit erhabenen polierten Zahlen, Gong - Bim Bam 3 Stäbe - 1/4 Westminsterschlag Werk 200

Oak with polished Caucasian walnut, gilt bezel, 6 3/4 inches, two-coloured figure-circle with polished raised figures, Gong - Gong „Bim Bam“: 3 rods - 1/4 Westminister chime

Chêne avec noyer Caucasiens poli, lunette dorée, 17 cm, cercle à chiffres bicolore avec chiffres polis en relief, Gong rond - Gong „Bim Bam“: 3 tiges - 1/4 Carillon Westminster

Roble con nogal Caucaso pulido, bisel dorado, 17 cm, cerco de cifras bicolor con cifras pulidas en relieve - Gong redondo - Gong „Bim Bam“: 3 varillas - 1/4 Carillon Westminster



21 x 39 cm = 8 1/4 x 15 3/4 inches

1017/960

Eiche mit kaukasisch Nußbaum poliert, 17 cm Goldlunette, vergoldeter Zahlenreif, Gong - Bim Bam 3 Stäbe - 1/4 Westminsterschlag Werk 200

Oak with polished Caucasian walnut, gilt bezel, 6 3/4 inches, gilt figure-circle, Gong - Gong „Bim Bam“: 3 rods - 1/4 Westminister chime

Chêne avec noyer Caucasiens poli, lunette dorée, 17 cm, cercle à chiffres doré, Gong rond - Gong „Bim Bam“: 3 tiges - 1/4 Carillon Westminster

Roble con nogal Caucaso pulido, bisel dorado, 17 cm, cerco de cifras dorado, Gong redondo - Gong „Bim Bam“: 3 varillas - 1/4 Carillon Westminster



21,5 x 40 cm = 8 1/2 x 15 3/4 inches

1017/1239

Eiche mit kaukasisch Nußbaum poliert, 18 cm Goldlunette, zweifarbiger Zahlenreif, Gong - Bim Bam 3 Stäbe - 1/4 Westminsterschlag Werk 200

Oak with polished Caucasian walnut, gilt bezel, 7 inches, two-coloured figure-circle, Gong - Gong „Bim Bam“: 3 rods - 1/4 Westminister chime

Chêne avec noyer Caucasiens poli, lunette dorée, 18 cm, cercle à chiffres bicolore, Gong rond - Gong „Bim Bam“: 3 tiges - 1/4 Carillon Westminster

Roble con nogal Caucaso pulido, bisel dorado, 18 cm, cerco de cifras bicolor, Gong redondo - Gong „Bim Bam“: 3 varillas - 1/4 Carillon Westminster



GRUPPE 1017

Tischuhren

Mantle Clocks - Pendules de cheminée - Relojes de sobremesa

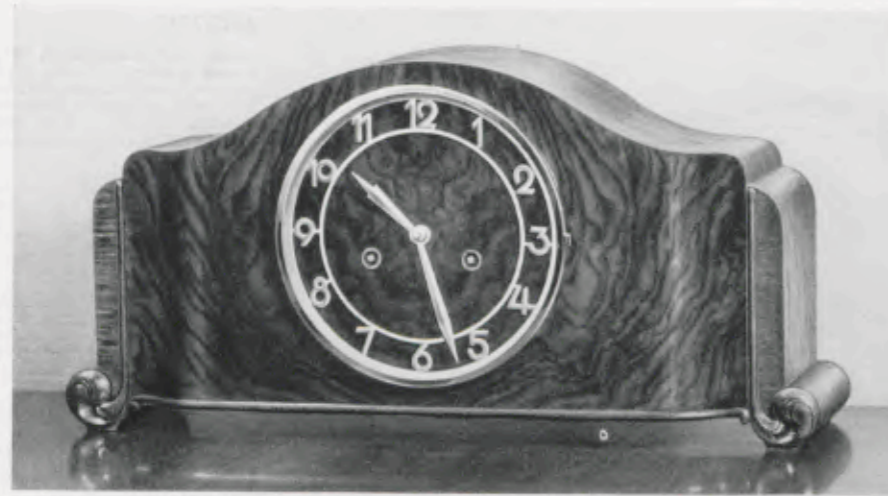

23 x 47 cm = 9 x 18 1/2 inches

1017/961

Eiche mit kaukasisch Nußbaum poliert, 18 cm Goldlunette, vergoldeter Zahlenreif mit gewölbten Zahlen, Gong - Bim Bam 5 Stäbe - 1/4 Westminsterschlag Werk 64

Oak with polished Caucasian walnut, gilt bezel, 7 inches, gilt figure-circle with embossed figures, Gong - Bim Bam 5 rods - 1/4 Westminister chime

Chêne avec noyer Caucasiens poli, lunette dorée, 18 cm, cercle à chiffres doré avec chiffres voûtés, Gong rond - Gong „Bim Bam“: 5 tiges - 1/4 Carillon Westminster

Roble con nogal Caucaso pulido, bisel dorado, 18 cm, cerco de cifras dorado con cifras encorvadas, Gong redondo - Gong „Bim Bam“: 5 varillas - 1/4 Carillon Westminster

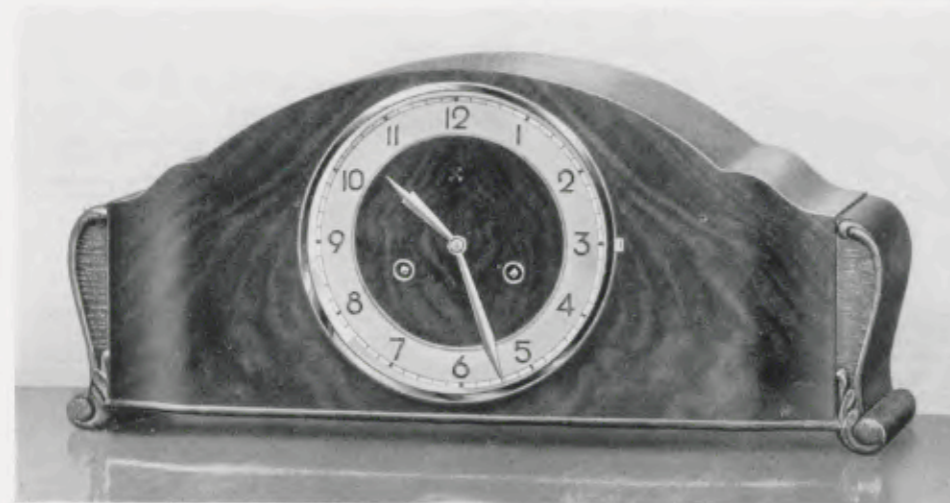

21,5 x 47 cm = 8 1/2 x 18 1/2 inches

1017/1258

Eiche mit kaukasisch Nußbaum poliert, 18 cm Goldlunette, zweifarbiger Zahlenreif mit erhabenen polierten Zahlen, Gong - Bim Bam 5 Stäbe, Gongabsteller - 1/4 Westminsterschlag Werk 64

Oak with polished Caucasian walnut, gilt bezel, 7 inches, two-coloured figure-circle with polished raised figures, Gong - Gong „Bim Bam“: 5 rods, Gong-stopper - 1/4 Westminister chime

Chêne avec noyer Caucasiens poli, lunette dorée, 18 cm, cercle à chiffres bicolore avec chiffres polis en relief, Gong rond - Gong „Bim Bam“: 5 tiges, avec dispositif d'arrêt de la sonnerie - 1/4 Carillon Westminster

Roble con nogal Caucaso pulido, bisel dorado, 18 cm, cerco de cifras bicolore con cifras pulidas en relieve, Gong redondo - Gong „Bim Bam“: 5 varillas, con parasonidos - 1/4 Carillon Westminster

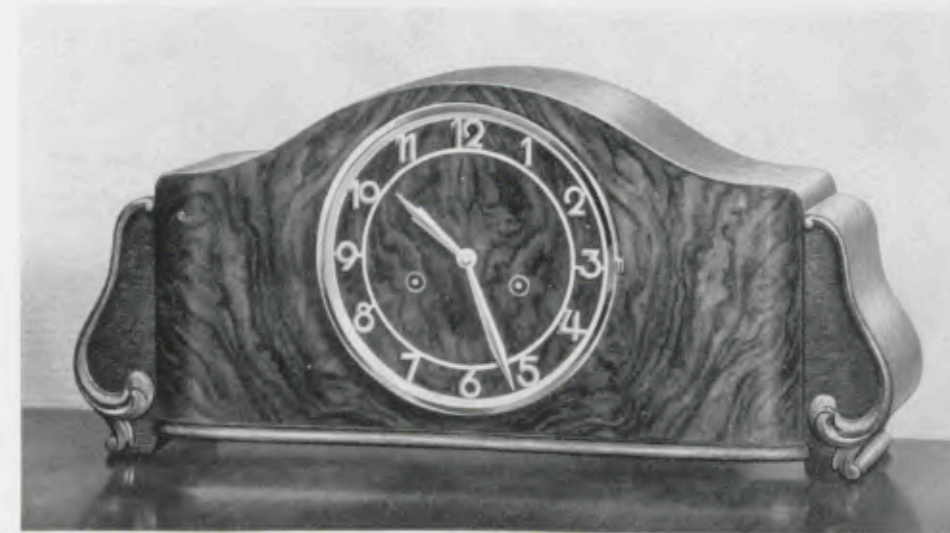

22,5 x 40 cm = 8 3/4 x 15 3/4 inches

1017/964

Eiche mit kaukasisch Nußbaum poliert, 18 cm Chromlunette, Silberzahlenreif mit gewölbten Zahlen, Gong - Bim Bam 5 Stäbe - 1/4 Westminsterschlag Werk 64

Oak with polished Caucasian walnut, chromium plated bezel, 7 inches, silvered circle with embossed figures, Gong - Gong „Bim Bam“: 5 rods - 1/4 Westminister chime

Chêne avec noyer Caucasiens poli, lunette chromée, 18 cm, cercle à chiffres argenté avec chiffres voûtés, Gong rond - Gong „Bim Bam“: 5 tiges - 1/4 Carillon Westminster

Roble con nogal Caucaso pulido, bisel cromado, 18 cm, cerco de cifras plateado con cifras encorvadas, Gong redondo - Gong „Bim Bam“: 5 varillas - 1/4 Carillon Westminster



GRUPPE 1017

Tischuhren

Mantle Clocks - Pendules de cheminée - Relojes de sobremesa

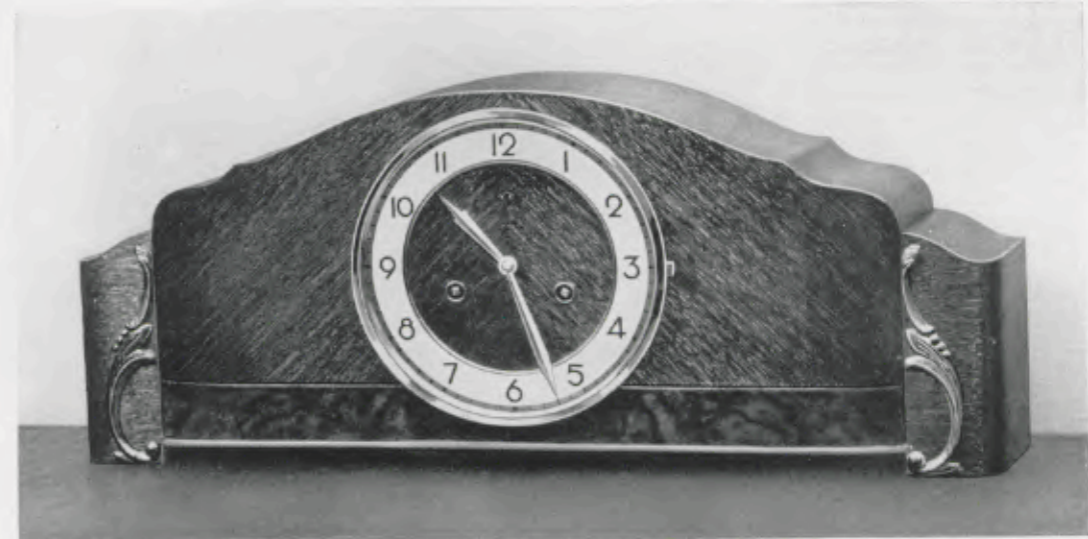

22 x 53 cm = 8 3/4 x 20 3/4 inches

1017/1251

Eiche mit Nußbaum poliert, 18 cm Chromlunette, Zahlenreif mit erhabenen polierten Zahlen, Gong - Bim Bam 5 Stäbe, Gongabsteller - 1/4 Westminsterschlag Werk 64

Oak with polished walnut, chromium plated bezel, 7 inches, figure-circle with polished raised figures, Gong - Gong „Bim Bam“: 5 rods, Gong-stopper - 1/4 Westminister chime

Chêne avec noyer poli, lunette chromée, 18 cm, cercle avec chiffres polis en relief, Gong rond - Gong „Bim Bam“: 5 tiges, avec dispositif d'arrêt de la sonnerie - 1/4 Carillon Westminster

Roble con nogal pulido, bisel cromado, 18 cm, cerco con cifras pulidas en relieve, Gong redondo - Gong „Bim Bam“: 5 varillas, con parasonidos - 1/4 Carillon Westminster



22 x 53 cm = 8 3/4 x 20 3/4 inches

1017/1277

Eiche mit kaukasisch Nußbaum poliert, 18 cm Goldlunette, zweifarbiger Zahlenreif, Gong - Bim Bam 5 Stäbe, Gongabsteller - 1/4 Westminsterschlag Werk 64

Oak with polished Caucasian walnut, gilt bezel, 7 inches, two-coloured figure-circle, Gong - Gong „Bim Bam“: 5 rods, with gong-stopper - 1/4 Westminister chime

Chêne avec noyer Caucasiens poli, lunette dorée, 18 cm, cercle à chiffres bicolore, Gong rond - Gong „Bim Bam“: 5 tiges, avec dispositif d'arrêt de la sonnerie - 1/4 Carillon Westminster

Roble con nogal Caucaso pulido, bisel dorado, 18 cm, cerco de cifras bicolore, Gong redondo - Gong „Bim Bam“: 5 varillas, con parasonidos - 1/4 Carillon Westminster



GRUPPE 1017

Tischuhren

Mantle Clocks - Pendules de cheminée - Relojes de sobremesa



23 x 56 cm = 9 x 22 inches

1017/1259

Eiche mit kaukasisch Nußbaum poliert, 18 cm Goldlunette, Zahlenreif mit aufgelegten Goldzahlen, Gong - Bim Bam 5 Stäbe, Gongabsteller - 1/4, Westminster Schlag Werk 64

Oak with polished Caucasian walnut, gilt bezel, 7 inches, figure-circle with gilt raised figures.

Gong - Gong „Bim Bam“: 5 rods, Gong-stopper - 1/4, Westminster chime

Chêne avec noyer Caucasiens poli, lunette dorée, 18 cm, cercle à chiffres avec chiffres dorés en relief, Gong rond - Gong „Bim Bam“: 5 tiges, avec dispositif d'arrêt de la sonnerie - 1/4, Carillon Westminster

Roble con nogal Cáucaso pulido, bisel dorado, 18 cm, cerco de cifras con cifras doradas en relieve, Gong redondo - Gong „Bim Bam“: 5 varillas, con parasonidos - 1/4, Carillon Westminster



GRUPPE 1017

Tischuhren

Mantle Clocks - Pendules de cheminée - Relojes de sobremesa

1017/967

Kaukasisch Nußbaum poliert, 17 cm Goldlunette, vergoldeter Zahlenreif, Gong - Bim Bam 3 Stäbe - 1/4, Westminster Schlag Werk 200

Polished Caucasian walnut, gilt bezel, 6 3/4 inches, gilt figure-circle, Gong - Gong „Bim Bam“: 3 rods - 1/4, Westminster chime

Noyer Caucasiens poli, lunette dorée, 17 cm, cercle à chiffres doré, Gong rond - Gong „Bim Bam“: 3 tiges - 1/4, Carillon Westminster

Nogal Cáucaso pulido, bisel dorado, 17 cm, cerco de cifras dorado - Gong redondo - Gong „Bim Bam“: 3 varillas - 1/4, Carillon Westminster



20 x 33 cm = 8 x 13 inches

1017/968

Kaukasisch Nußbaum poliert, 17 cm Goldlunette, vergoldeter Zahlenreif, Gong - Bim Bam 3 Stäbe - 1/4, Westminster Schlag Werk 200

Polished Caucasian walnut, gilt bezel, 6 3/4 inches, gilt figure-circle, Gong - Gong „Bim Bam“: 3 rods - 1/4, Westminster chime

Noyer Caucasiens poli, lunette dorée, 17 cm, cercle à chiffres doré, Gong rond - Gong „Bim Bam“: 3 tiges - 1/4, Carillon Westminster

Nogal Cáucaso pulido, bisel dorado, 17 cm, cerco de cifras dorado, Gong redondo - Gong „Bim Bam“: 3 varillas - 1/4, Carillon Westminster

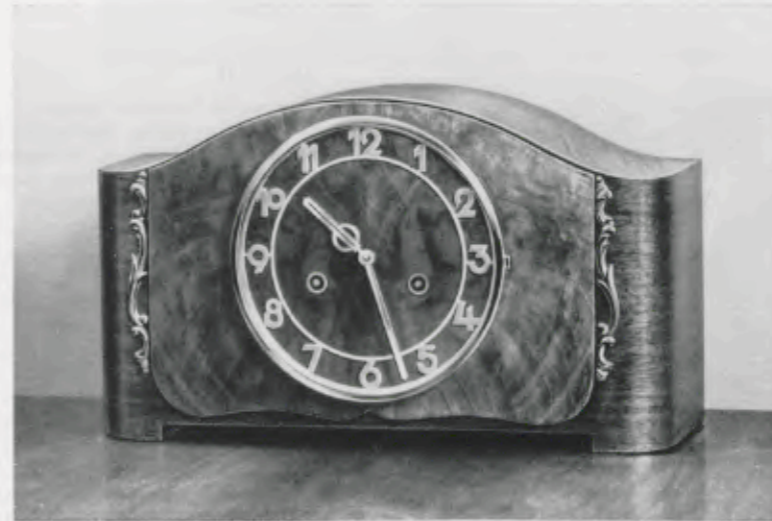

20,5 x 35 cm = 8 x 13 3/4 inches

1017/1246

Kaukasisch Nußbaum poliert, 17 cm Chromlunette, Zahlenreif mit erhabenen polierten Zahlen, Rundgong - Bim Bam 3 Stäbe - 1/4, Westminster Schlag Werk 200

Polished Caucasian walnut, chromium plated bezel, 6 3/4 inches, figure-circle with polished raised figures, Gong - Gong „Bim Bam“: 3 rods - 1/4, Westminster chime

Noyer Caucasiens poli, lunette chromée, 17 cm, cercle à chiffres avec chiffres polis en relief, Gong rond - Gong „Bim Bam“: 3 tiges - 1/4, Carillon Westminster

Nogal Cáucaso pulido, bisel cromado, 17 cm, cerco de cifras con cifras pulidas en relieve, Gong redondo - Gong „Bim Bam“: 3 varillas - 1/4, Carillon Westminster



20,5 x 38 cm = 8 x 14 1/4 inches



GRUPPE 1017

Tischuhren

Mantle Clocks - Pendules de cheminée - Relojes de sobremesa

1017/998

Kaukasisch Nußbaum poliert, 17cm Goldlunette, zweifarb. Zahlenreif mit erhabenen polierten Zahlen, Rundgong - Bim Bam 3 Stäbe - $\frac{1}{4}$, Westminster Schlag Werk 200

Polished Caucasian walnut, gilt bezel, 6 $\frac{1}{4}$ inches, two-coloured figure-circle with polished raised figures, Gong - Gong „Bim Bam“: 3 rods - $\frac{1}{4}$, Westminster chime

Noyer Caucasic poli, lunette dorée, 17 cm, cercle à chiffres bicolor avec chiffres polis en relief, Gong rond - Gong „Bim Bam“: 3 tiges - $\frac{1}{4}$, Carillon Westminster

Nogal Cáucaso pulido, bisel dorado, 17 cm, cerco de cifras bicolor con cifras pulidas en relieve, Gong redondo Gong „Bim Bam“: 3 varillas - $\frac{1}{4}$, Carillon Westminster

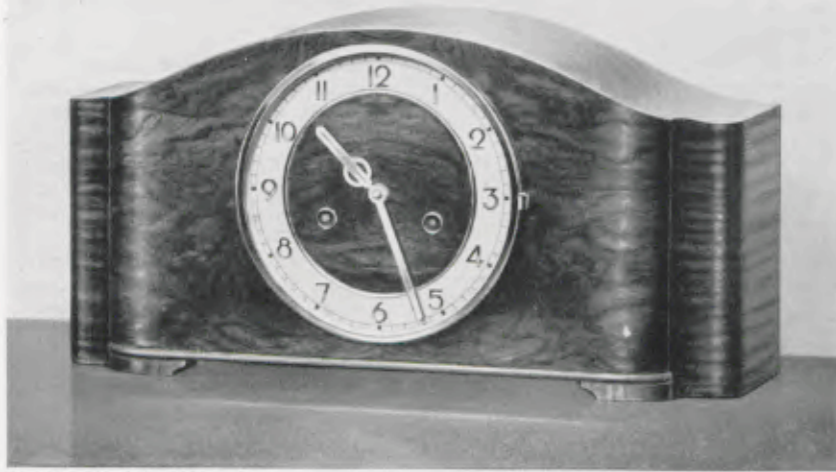
21 x 39 cm - 8 $\frac{1}{4}$ x 15 $\frac{3}{4}$ inches

1017/1241

Kaukasisch Nußbaum poliert, 18 cm Goldlunette, Zahlenreif mit aufgelegten polierten Goldzahlen, Gong - Bim Bam 5 Stäbe, Gongabsteller $\frac{1}{4}$, Westminster Schlag Werk 200

Polished Caucasian walnut, gilt bezel, 7 inches, circle with polished gilt figures, Gong - Gong „Bim Bam“: 5 rods, with gong-stopper - $\frac{1}{4}$, Westminster chime

Noyer Caucasic poli, lunette dorée, 18 cm, cercle avec chiffres appliqués dorés poli, Gong rond - Gong „Bim Bam“: 5 tiges, avec dispositif d'arrêt de la sonnerie - $\frac{1}{4}$, Carillon Westminster

Nogal Cáucaso pulido, bisel dorado, 18 cm, cerco con cifras aplicadas doradas pulidas, Gong redondo - Gong „Bim Bam“: 5 varillas, con parasonidos - $\frac{1}{4}$, Carillon Westminster

22 x 42.5 cm - 8 $\frac{3}{4}$ x 16 $\frac{3}{4}$ inches

1017/970

Kaukasisch Nußbaum poliert, 18 cm Goldlunette, vergoldeter Zahlenreif mit gewölbten Zahlen, Gong - Bim Bam 5 Stäbe, Gongabsteller - $\frac{1}{4}$, Westminster Schlag Werk 64

Polished Caucasian walnut, gilt bezel, 7 inches, gilt circle with embossed figures, Gong - Gong „Bim Bam“: 5 rods, gong-stopper - $\frac{1}{4}$, Westminster chime

Noyer Caucasic poli, lunette dorée, 18 cm, cercle à chiffres doré avec chiffres voûtés, Gong rond - Gong „Bim Bam“: 5 tiges, avec dispositif d'arrêt de la sonnerie - $\frac{1}{4}$, Carillon Westminster

Nogal Cáucaso pulido, bisel dorado, 18 cm, cerco de cifras dorado con cifras encorvadas, Gong redondo - Gong „Bim Bam“: 5 varillas, con parasonidos - $\frac{1}{4}$, Carillon Westminster

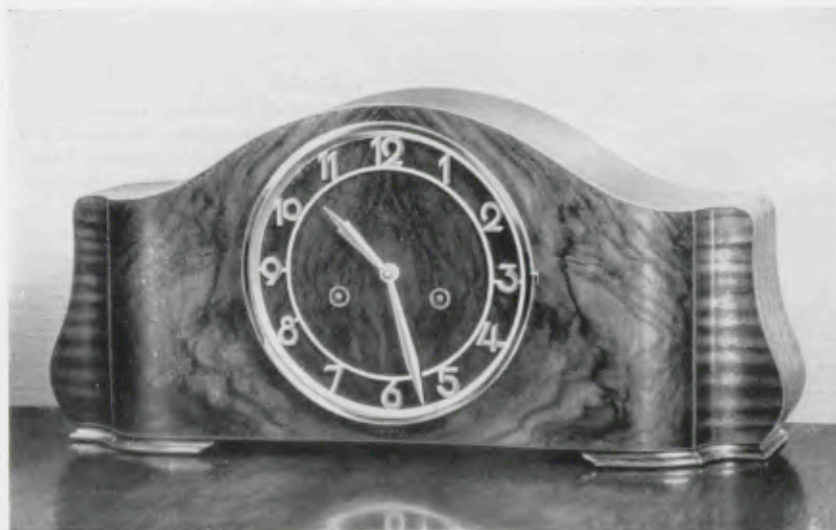
21 x 46 cm - 8 $\frac{3}{4}$ x 18 $\frac{1}{4}$ inches

GRUPPE 1017

Tischuhren

Mantle Clocks - Pendules de cheminée - Relojes de sobremesa

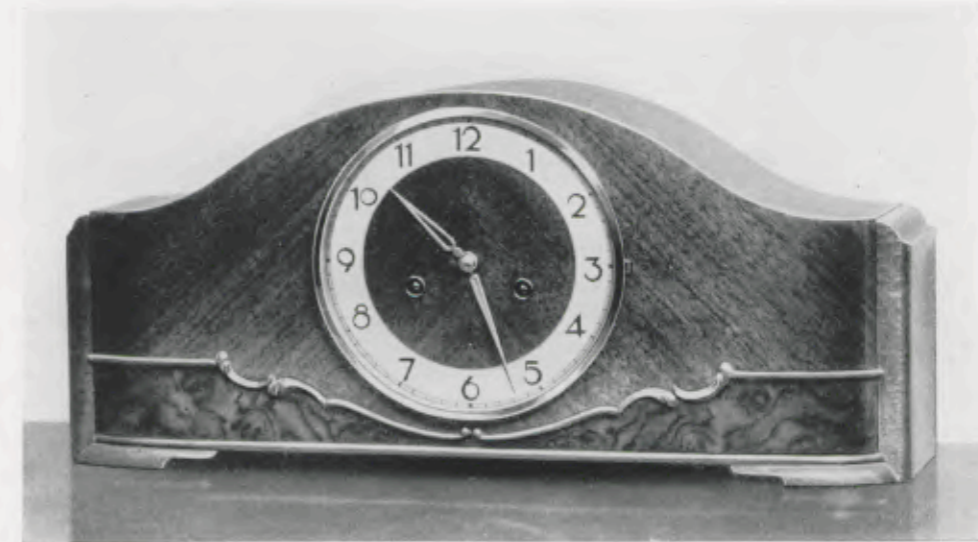
22 x 50 cm - 8 $\frac{3}{4}$ x 19 $\frac{1}{4}$ inches

1017/1279

Nußbaum poliert, 18 cm Goldlunette, Zahlenreif mit aufgelegten Goldzahlen Gong - Bim Bam 5 Stäbe, Gongabsteller - $\frac{1}{4}$, Westminster Schlag Werk 64

Polished walnut, gilt bezel, 7 inches, circle with gilt raised figures Gong - Gong „Bim Bam“: 5 rods, with gong-stopper - $\frac{1}{4}$, Westminster chime

Noyer poli, lunette dorée, 18 cm, cercle avec chiffres appliqués dorés Gong rond - Gong „Bim Bam“: 5 tiges, avec dispositif d'arrêt de la sonnerie - $\frac{1}{4}$, Carillon Westminster

Nogal pulido, bisel dorado, 18 cm, cerco con cifras aplicadas doradas Gong redondo - Gong „Bim Bam“: 5 varillas, con parasonidos - $\frac{1}{4}$, Carillon Westminster

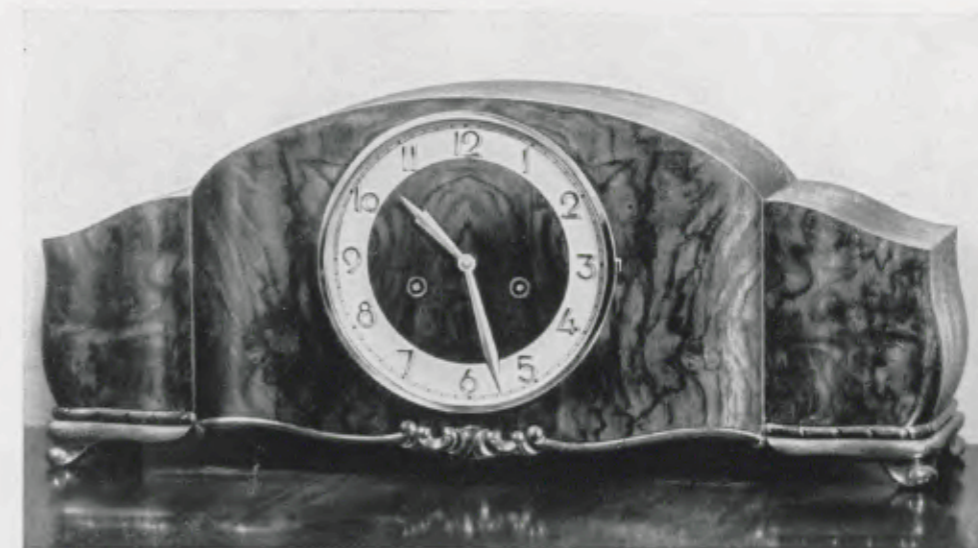
22.5 x 55 cm - 9 x 21 $\frac{1}{2}$ inches

1017/976

Kaukasisch Nußbaum poliert, 18 cm Goldlunette, Zahlenreif mit aufgelegten polierten Goldzahlen Gong - Bim Bam 5 Stäbe, Gongabsteller - $\frac{1}{4}$, Westminster Schlag Werk 200

Polished Caucasian walnut, gilt bezel, 7 inches, circle with polished gilt figures Gong - Gong „Bim Bam“: 5 rods, with gong-stopper - $\frac{1}{4}$, Westminster chime

Noyer Caucasic poli, lunette dorée, 18 cm, cercle avec chiffres appliqués dorés poli Gong rond - Gong „Bim Bam“: 5 tiges, avec dispositif d'arrêt de la sonnerie - $\frac{1}{4}$, Carillon Westminster

Nogal Cáucaso pulido, bisel dorado, 18 cm, cerco con cifras aplicadas doradas pulidas Gong redondo - Gong „Bim Bam“: 5 varillas, con parasonidos - $\frac{1}{4}$, Carillon Westminster



GRUPPE 1017

Tischuhren

Mantle Clocks - Pendules de cheminée - Relojes de sobremesa



21,5 x 40 cm - 8 1/2 x 15 3/4 inches

1017/1260

Nußbaum feinmatt antik, 18 cm Goldlunette, brauner Zahlenreif mit aufgelegten Goldzahlen
Gong - Bim Bam 3 Stäbe - 1/4 Westminster Werk 200
Dull antique figured walnut, gilt bezel, 7 inches, brown figure-circle with gilt raised figures
Gong - Gong „Bim Bam“: 3 rods - 1/4 Westminster chime
Noyer mat antique, lunette dorée, 18 cm, cercle à chiffres brun avec chiffres dorés en relief
Gong rond - Gong „Bim Bam“: 3 tiges - 1/4 Carillon Westminster
Nogal mate antiguo, bisel dorado, 18 cm, cerco de cifras color marron con cifras doradas en relieve
Gong redondo - Gong „Bim Bam“: 3 varillas - 1/4 Carillon Westminster

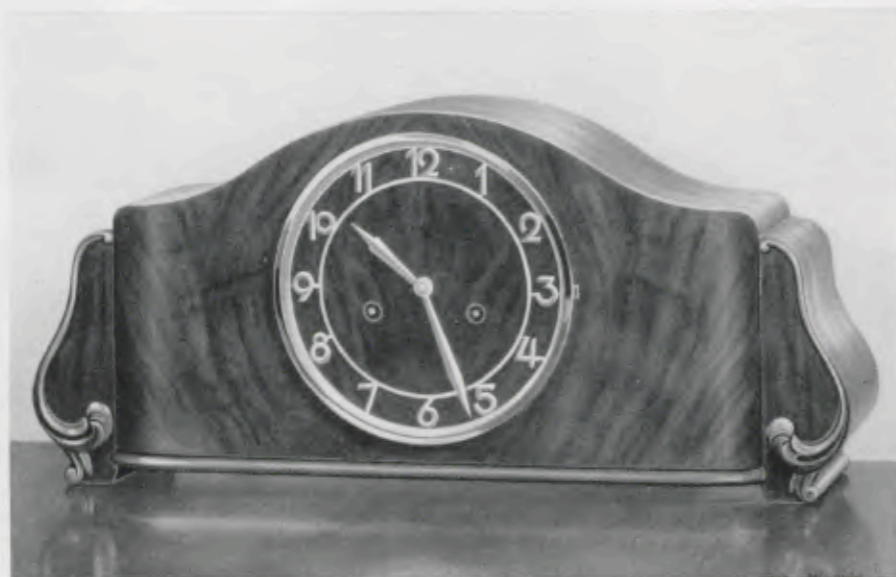

22,5 x 40 cm - 8 7/8 x 15 3/4 inches

1017/965

Nußbaum feinmatt antik, 18 cm Goldlunette, vergoldeter Zahlenreif mit gewölbten Zahlen
Gong - Bim Bam 5 Stäbe - 1/4 Westminsterschlag Werk 64
Dull antique figured walnut, gilt bezel, 7 inches, gilt figure-circle with embossed figures
Gong - Gong „Bim Bam“: 5 rods - 1/4 Westminster chime
Noyer mat antique, lunette dorée, 18 cm, cercle à chiffres doré avec chiffres voutés
Gong rond - Gong „Bim Bam“: 5 tiges - 1/4 Carillon Westminster
Nogal mate antiguo, bisel dorado, 18 cm, cerco de cifras dorado con cifras encorvadas
Gong redondo - Gong „Bim Bam“: 5 varillas - 1/4 Carillon Westminster



GRUPPE 1017

Tischuhren

Mantle Clocks - Pendules de cheminée - Relojes de sobremesa



23,5 x 45 cm - 9 1/4 x 17 3/4 inches

1017/1273

Nußbaum feinmatt antik, 18 cm Goldlunette, aufgelegte vergoldete Zahlen
Gong - Bim Bam 5 Stäbe, Gongabsteller - 1/4 Westminsterschlag Werk 200
Dull antique figured walnut, gilt bezel, 7 inches, gilt raised figures
Gong - Gong „Bim Bam“: 5 rods, gong-stopper - 1/4 Westminster chime
Noyer mat antique, lunette dorée, 18 cm, chiffres dorés en relief
Gong rond - Gong „Bim Bam“: 5 tiges, avec dispositif d'arrêt de la sonnerie - 1/4 Carillon Westminster
Nogal mate antiguo, bisel dorado, 18 cm, cifras doradas en relieve
Gong redondo - Gong „Bim Bam“: 5 varillas, con parasonidos - 1/4 Carillon Westminster

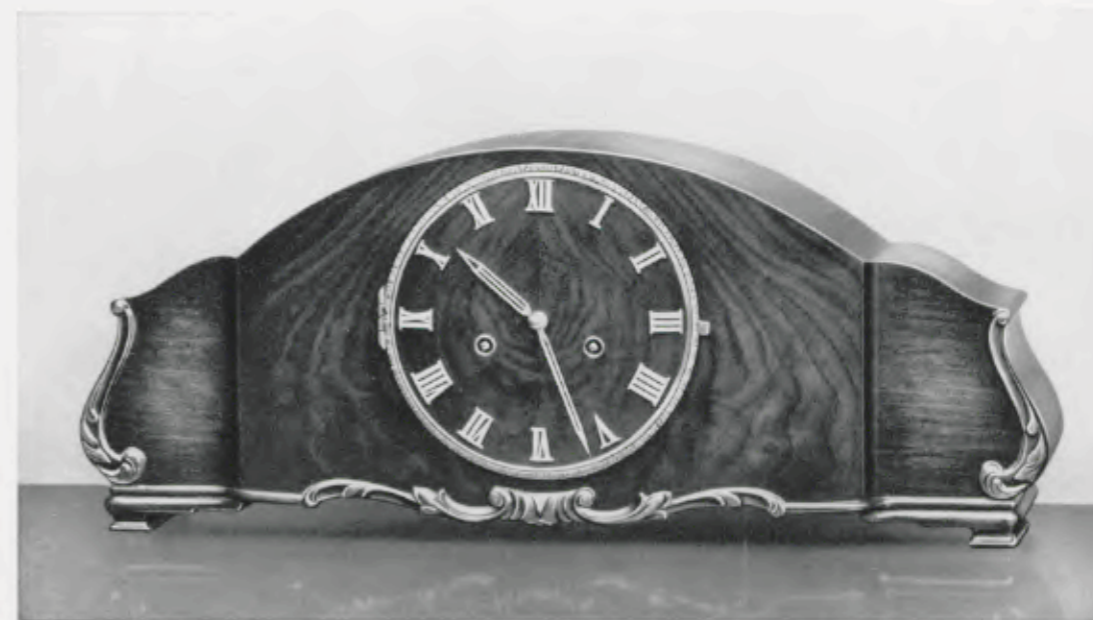

23 x 56 cm - 9 x 22 inches

1017/1281

Nußbaum feinmatt antik, 18 cm Goldlunette, aufgelegte vergoldete Zahlen, Gong - Bim Bam 5 Stäbe,
Massivwerk, Gongabsteller - 1/4 Westminsterschlag Werk 64
Dull antique figured walnut, gilt bezel, 7 inches, gilt raised figures, Gong - Gong „Bim Bam“: 5 rods,
solid movement, with gong-stopper - 1/4 Westminster chime
Noyer mat antique, lunette dorée, 18 cm, chiffres dorés appliqués, Gong rond - Gong „Bim Bam“: 5 tiges,
mouvement massif, avec dispositif d'arrêt de la sonnerie - 1/4 Carillon Westminster
Nogal mate antiguo, bisel dorado, 18 cm, cifras doradas aplicadas, Gong redondo - Gong „Bim Bam“: 5 varillas,
máquina maciza, con parasonidos - 1/4 Carillon Westminster



GRUPPE 1017

Tischuhren

Mantle Clocks - Pendules de cheminée - Relojes de sobremesa

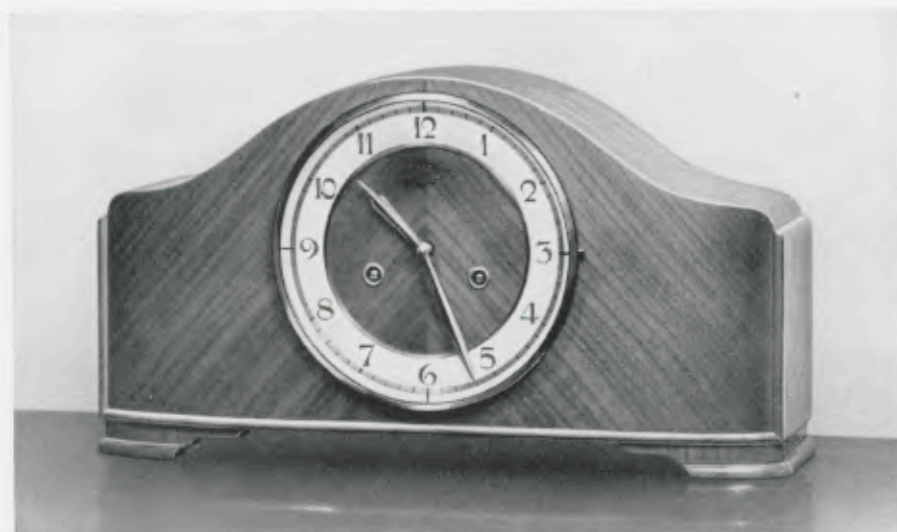

22 x 42 cm = 8 3/4 x 16 1/2 inches

1017/1262

Kirschbaum poliert, 18 cm Goldlunette, zweifarbiger Zahlenreif
 Gong - Bim Bam 5 Stäbe, Massivwerk, Gongabsteller - 1/4 Westminsterschlag Werk 200
 Polished cherry wood, gilt bezel, 7 inches, two-coloured figure-circle
 Gong - Gong „Bim Bam“: 5 rods, solid movement, gong-stopper - 1/4 Westminister chime
 Cerisier poli, lunette dorée, 18 cm, cercle à chiffres bicolore
 Gong rond - Gong „Bim Bam“: 5 tiges, mouvement massif, avec dispositif d'arrêt de la sonnerie
 1/4 Carillon Westminster
 Cerezo pulido, bisel dorado, 18 cm, cerco de cifras bicolor
 Gong redondo - Gong „Bim Bam“: 5 varillas, máquina maciza, con parasonidos
 1/4 Carillon Westminster

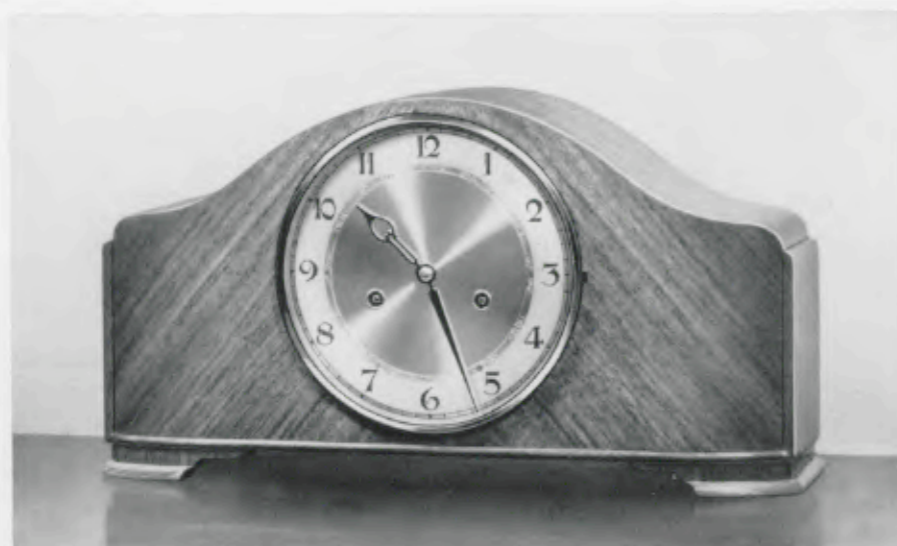

22 x 42 cm = 8 3/4 x 16 1/2 inches

1017/1263

Nußbaum poliert, 18 cm Goldlunette, Zifferblatt Messing geätzt
 Gong - Bim Bam 5 Stäbe, Massivwerk, Gongabsteller - 1/4 Westminsterschlag Werk 200
 Polished walnut, gilt bezel, 7 inches, etched brass dial
 Gong - Gong „Bim Bam“: 5 rods, solid movement, gong-stopper - 1/4 Westminister chime
 Noyer poli, lunette dorée, 18 cm, cadran laiton corrodé
 Gong - Gong „Bim Bam“: 5 tiges, mouvement massif, avec dispositif d'arrêt de la sonnerie
 1/4 Carillon Westminster
 Nogal pulido, bisel dorado, 18 cm, esfera latón mate pulido
 Gong - Gong „Bim Bam“: 5 varillas, máquina maciza, con parasonidos - 1/4 Carillon Westminster



GRUPPE 1017

Tischuhren

Mantle Clocks - Pendules de cheminée - Relojes de sobremesa

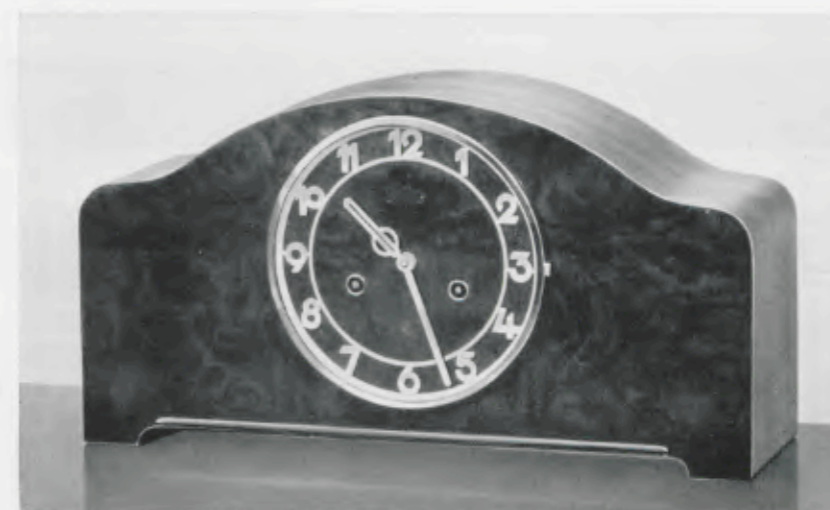

21 x 41 cm = 8 1/4 x 16 1/8 inches

1017/1091

Nußbaum poliert, 18 cm Chromlunette, matt versilberter Zahlenreif
 Rundgong - Bim Bam 3 Stäbe
 Polished walnut, chromium plated bezel, 8 1/4 inches, dull silvered figure-circle
 Gong - Gong „Bim Bam“: 3 rods
 Noyer poli, lunette chromée, 17 cm, cercle à chiffres argenté mat
 Gong rond - Gong „Bim Bam“: 3 tiges
 Nogal pulido, bisel cromado, 17 cm, cerco de cifras plateado mate
 Gong redondo - Gong „Bim Bam“: 3 varillas

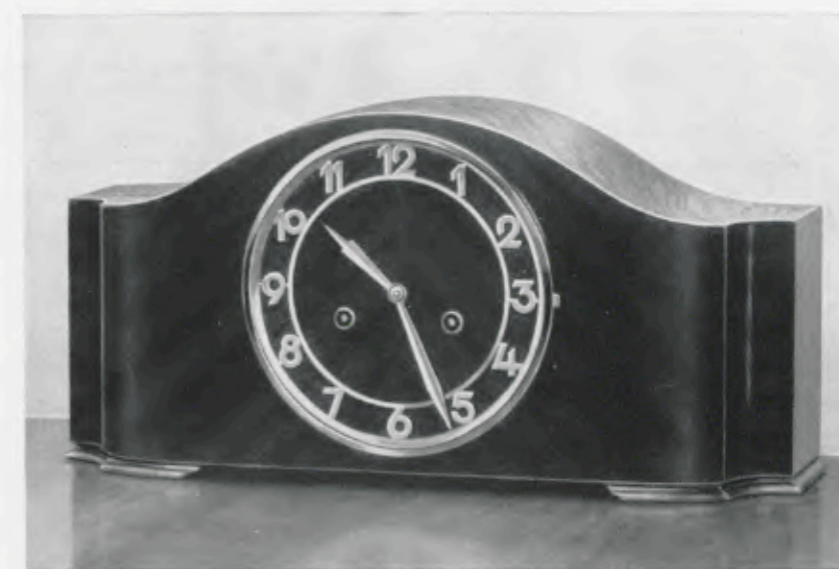

21,5 x 43 cm = 8 1/2 x 16 inches

1017/954

Mahagoni poliert, 18 cm Chromlunette, matt versilberter Zahlenreif
 Gong - Bim Bam 5 Stäbe - 1/4 Westminsterschlag Werk 200
 Polished mahogany, chromium plated bezel, 7 inches, dull silvered figure-circle
 Gong - Gong „Bim Bam“: 5 rods - 1/4 Westminister chime
 Acajou poli, lunette chromée, 18 cm, cercle à chiffres argenté mat
 Gong rond - Gong „Bim Bam“: 5 tiges - 1/4 Carillon Westminster
 Caoba pulida, bisel cromado, 18 cm, cerco de cifras plateado mate
 Gong redondo - Gong „Bim Bam“: 5 varillas - 1/4 Carillon Westminster



GRUPPE 1017

Konsolen - Brackets - Consoles - Consolas

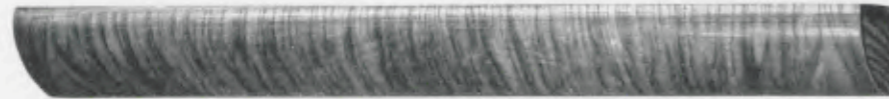

Konsole 1017/2 Kaukasisch Nußbaum poliert - Polished Caucasian walnut
 Noyer Caucasiens poli - Nogal Caucaso pulido = 50 x 16 x 5,5 cm = 19 3/4 x 6 1/4 x 2 1/4 inches

Konsole 1017/3 Eiche - Oak - Chêne - Roble = 50 x 16 x 5,5 cm = 19 3/4 x 6 1/4 x 2 1/4 inches



Konsole 1017/4 Nußbaum poliert - Polished walnut - Noyer poli - Nogal pulido = 45 x 16,5 x 8 cm = 17 3/4 x 6 1/2 x 3 1/4 inches

Konsole 1017/5 Eiche - Oak - Chêne - Roble = 45 x 16,5 x 8 cm = 17 3/4 x 6 1/2 x 3 1/4 inches

Konsole 1017/6 Nußbaum poliert - Polished walnut - Noyer poli - Nogal pulido = 55 x 16,5 x 8 cm = 21 3/4 x 6 1/2 x 3 1/4 inches

Konsole 1017/7 Eiche - Oak - Chêne - Roble = 55 x 16,5 x 8 cm = 21 3/4 x 6 1/2 x 3 1/4 inches

Für alle Tischuhren lieferbar

Can be used for all clocks - Tous les modèles sont livrables avec console - Con consola se suministran todos los modelos

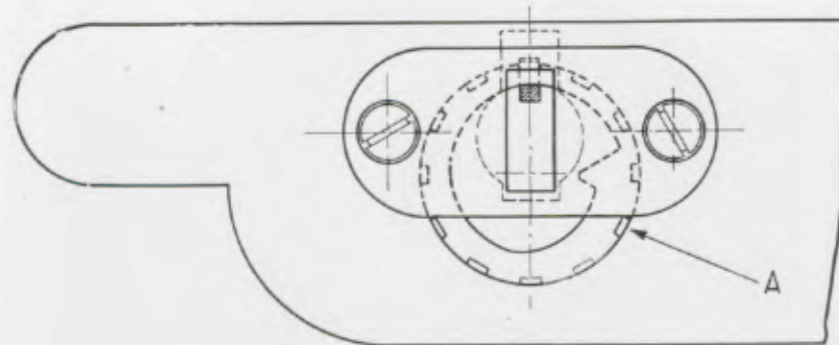

Aufhängevorrichtung der Konsole D. R. P. a.

Durch Drehen der Scheibe A kann die Konsole jederzeit leicht in eine absolut waagrechte Lage gebracht werden.

Suspension device of bracket. Patented.

The bracket can easily be brought into an absolutely horizontal position by turning disc A.

Dispositif de suspension de la console D. R. P. a.

En tournant le disque A, on peut en tout temps mettre la console en position absolument horizontale.

Aparato para suspender la consola D. R. P. a.

Dando vueltas al disco A, la consola siempre se puede poner facilmente en una posición absolutamente horizontal.



GRUPPE 1018

Einsatzuhren, Rundrahmenuhren, Bürouhren, Dropuhren

Clocks for fitting into furniture - Dial Clocks - Office Clocks - Drop Dial Clocks

Pendules à encastrer - Cèils de Bœuf - Pendules pour Bureaux - Pendules octogones

Relojes para colocar en estantes, muebles etc.

Relojes de pared, forma ojo de buey - Relojes para despachos

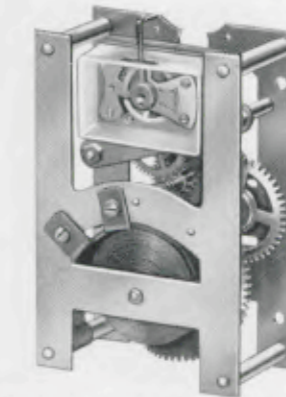

Platinen - Plates - Platinas - Platinas
8 x 6 cm = 3 1/4 x 2 1/4 inches

No. 184

8 Tag Ankergehwerk, Echappement mit 7 Steinen

8 day lever time movement, escapement with 7 jewels

8 jours simple, échappement à ancre avec 7 rubis

Máquina 8 días cuerda, escape à áncora con 7 rubis



Platinen - Plates - Platinas - Platinas
5,5 x 5 cm = 2 1/4 x 2 inches

No. 239

8 Tag Ankergehwerk, 2 Steinkörner, Nivarox-Spirale, normale Lebensdauer, unempfindlich gegen Temperaturschwankungen

8 day lever time movement, 2 endstones, normal longevity, Nivarox-hairspring, insensible to differences in temperature

Mouvement 8 jours simple à ancre, fond et pointe empierrés, spiral Nivarox, durabilité normale, insensible aux changements de température

Máquina 8 días cuerda à áncora, fondo y punta con rubis, espiral Nivarox, durabilidad normal, insensible à los cambios de temperatura

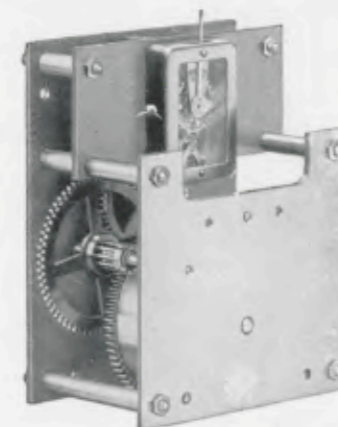

Platinen - Plates - Platinas - Platinas
9,5 x 7,5 cm = 3 3/4 x 3 inches

No. 146

8 Tag Marine-Präzisionswerk mit 7 Steinen, staubdicht abgedeckte Taschenuhrhemmung

Precision lever movement, 8 day time, escapement with 7 jewels under dust-proof protector

Mouvement de précision, 8 jours simple, échappement hermétiquement fermé avec 7 rubis

Máquina de precisión, 8 días cuerda, escape hermético à áncora con 7 rubis



GRUPPE 1018

Einsatzzuhren, Rundrahmuhren, Bürouhren, Dropuhren

Clocks for fitting into furniture - Dial Clocks - Office Clocks - Drop Dial Clocks
Pendules à encastrer - Cils de Bœuf - Pendules pour Bureaux - Pendules octogones
Relojes para colocar en estantes, muebles etc.
Relojes de pared, forma ojo de bue - Relojes para despachos

No. 247

8 Tag Pendelgehwerk, schweres Pendel, mit einfacher und sicherer Transportbefestigung

8 day pendulum time movement, heavy pendulum, simple and securely fastened for transport

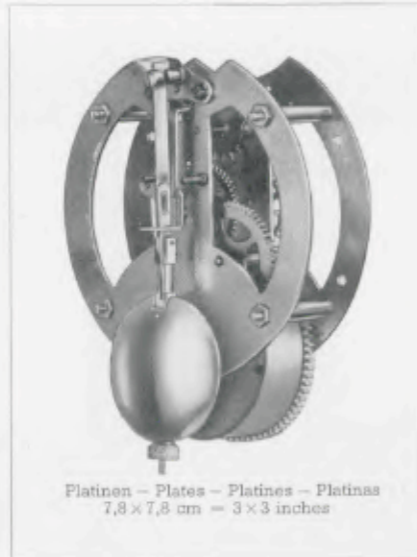

Platinen - Plates - Platines - Platinas
7,8 x 7,8 cm = 3 x 3 inches

Mouvement 8 jours simple à balancier, balancier lourd, simple et sûrement attaché pour éviter tout dégât

Máquina 8 días cuerda á péndula, péndula pesada, simple y seguramente atado impidiendo causar daños

No. 74

14 Tag Pendelgehwerk

14 day pendulum time movement



Platinen - Plates - Platines - Platinas
8,5 x 8,2 cm = 3 1/4 x 3 1/4 inches

Mouvement à balancier, 15 jours simple

Máquina á péndula, 15 días cuerda

No. 52

8 Tag Pendelgehwerk, schweres Pendel, mit einfacher und sicherer Transportbefestigung

8 day pendulum time movement, heavy pendulum, simple and securely fastened for transport

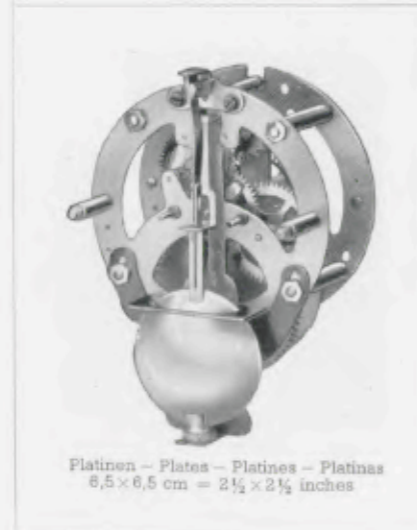

Platinen - Plates - Platines - Platinas
8,5 x 6,5 cm = 2 1/4 x 2 1/4 inches

Mouvement 8 jours simple à balancier, balancier lourd, simple et sûrement attaché pour éviter tout dégât

Máquina 8 días cuerda á péndula, péndula pesada, simple y seguramente atado impidiendo causar daños



GRUPPE 1018

Einsatzzuhren zum Einbauen in Möbel, Büfets usw.

Dial clocks for fitting into furniture, sideboards etc. - Pendules à encastrer pour meubles, buffets etc.
Relojes para colocar en estantes, muebles etc.



1018/1



1018/2

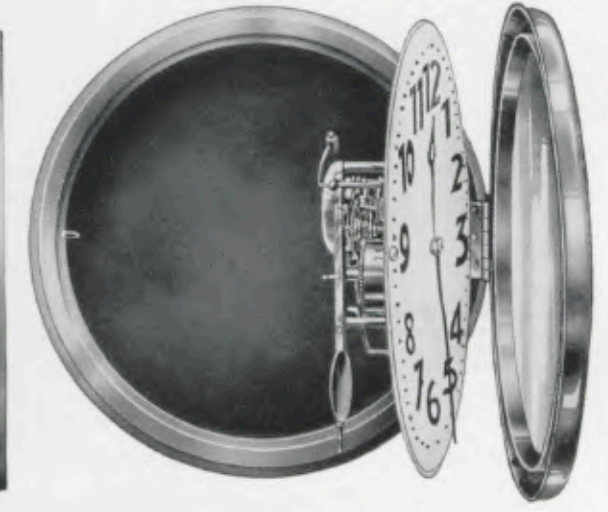
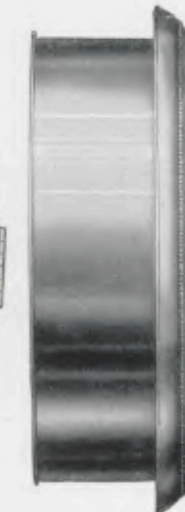

14 Tag Pendelgehwerk - 14 day pendulum time - 15 jours simple à balancier
Máquina á péndula, 15 días cuerda

Chromlünetten - Chromium plated bezels - Lunettes chromées
Biseles cromados

Abmessungen - Dimensions - Dimensiones

No.	Silberblatt - Silver dial - Cadran argenté - Esfera plateada		Hintergehäuse - Back case - Tambour - Caja	
	Minutenkreisdurchmesser Diameter of minute circle Diamètre du cercle minutes Diámetro del círculo de minutos	Lünettendurchmesser Diameter of bezel Diamètre extér. de la lunette Diámetro total del bisel	Durchmesser Diameter Diamètre Diámetro	Tiefe Depth Profondeur Profundidad
1018/1	225 mm = 9 inches	275 mm = 10 3/4 inches	232 mm = 9 1/4 inches	80 mm = 3 1/4 inches
1018/2	262 mm = 10 inches	333 mm = 13 1/4 inches	280 mm = 11 inches	80 mm = 3 1/4 inches



GRUPPE 1018



Glaszifferblatt

Glass dial - Cadran verre - Esfera de vidrio

Rahmen - Frame - Cadre - Marco		Zifferblatt - Dial - Cadran - Esfera	
Buche, hell poliert Light beech polished Hêtre clair poli Haya clara pulida	Nußbaumfarbig Walnut finish Teinte noyer Color nogal	Durchmesser Diameter Diamètre Diámetro	Minutenkreisdurchmesser Diameter of minute circle Diamètre du cercle minutes Diámetro del círculo de minutos
1018/202 1018/204 1018/205	1018/203 1018/206 1018/207	276 = 11 mm inches	184 = 7 mm inches
8 Tag Pendelgehwerk - 8 day pendulum time - 8 jours simple à balancier - 8 días cuerda á péndula		14 Tag Gehwerk - 14 day time - 15 jours simple - 15 días cuerda	
14 Tag Schlagwerk - 14 day strike - 15 jours sonnerie - 15 días sonería			
1018/208 1018/209	1018/210 1018/211	315 = 12 1/2 mm inches	216 = 8 1/2 mm inches
14 Tag Gehwerk - 14 day time - 15 jours simple - 15 días cuerda		14 Tag Schlagwerk - 14 day strike - 15 jours sonnerie - 15 días sonería	
1018/212 1018/213		364 = 14 3/4 mm inches	262 = 10 mm inches
14 Tag Gehwerk - 14 day time - 15 jours simple - 15 días cuerda		14 Tag Schlagwerk - 14 day strike - 15 jours sonnerie - 15 días sonería	

1018/202-203 : mit Blechhinterkasten - with metal case - avec boîte en tôle - con caja de hojalata



GRUPPE 1018



Zelluloid-Zifferblatt, bombiertes Glas

Celluloid dial, convex glass - Cadran celluloid, verre bombé - Esfera de celuloide, cristal bombado

Rahmen - Frame - Cadre - Marco			Zifferblatt - Dial - Cadran - Esfera	
Buche, hell poliert Light beech polished Hêtre clair poli Haya clara pulida	Nußbaumfarbig Walnut finish Teinte noyer Color nogal	Weiß lackiert White lacquered Verni blanc Barnizado en blanco	Durchmesser * Diameter Diamètre Diámetro	Minutenkreisdurchmesser Diameter of minute circle Diamètre du cercle minutes Diámetro del círculo de minutos
1018/216 1018/218 1018/219	1018/217 1018/220 1018/221	1018/236	276 = 11 mm inches	184 = 7 mm inches
8 Tag Pendelgehwerk - 8 day pendulum time - 8 jours simple à balancier - 8 días cuerda á péndula		14 Tag Gehwerk - 14 day time - 15 jours simple - 15 días cuerda		
14 Tag Schlagwerk - 14 day strike - 15 jours sonnerie - 15 días sonería				
1018/222 1018/223	1018/224 1018/225		315 = 12 1/2 mm inches	216 = 8 1/2 mm inches
14 Tag Gehwerk - 14 day time - 15 jours simple - 15 días cuerda		14 Tag Schlagwerk - 14 day strike - 15 jours sonnerie - 15 días sonería		
1018/226 1018/227	1018/228 1018/229		364 = 14 1/2 mm inches	262 = 10 mm inches
14 Tag Gehwerk - 14 day time - 15 jours simple - 15 días cuerda		14 Tag Schlagwerk - 14 day strike - 15 jours sonnerie - 15 días sonería		
	1018/232 1018/233		400 = 15 3/4 mm inches	305 = 12 mm inches
14 Tag Gehwerk - 14 day time - 15 jours simple - 15 días cuerda		14 Tag Schlagwerk - 14 day strike - 15 jours sonnerie - 15 días sonería		



GRUPPE 1018



Messinglunette, Lackblatt

Brass bezel, lacquered dial - Lunette laiton, cadran verni - Bisel de latón, esfera esmaltada

Rahmen - Frame - Cadre - Marco		Zifferblatt - Dial - Cadran - Esfera	
Eiche Oak Chêne Roble	Nußbaumfarbig Walnut finish Teinte noyer Color nogal	Durchmesser Diameter Diamètre Diámetro	Minutenkreisdurchmesser Diameter of minute circle Diamètre du cercle minutes Diámetro del círculo de minutos
1018/133 1018/134	1018/135 1018/136	34 = 13½ cm inches 14 Tag Gehwerk - 14 day time - 15 jours simple - 15 días cuerda 14 Tag Schlagwerk - 14 day strike - 15 jours sonnerie - 15 días sonería	184 = 7 mm inches
1018/137 1018/138	1018/139 1018/140	38 = 15 cm inches 14 Tag Gehwerk - 14 day time - 15 jours simple - 15 días cuerda 14 Tag Schlagwerk - 14 day strike - 15 jours sonnerie - 15 días sonería	225 = 9 mm inches
1018/141 1018/142	1018/143 1018/144	46 = 18 cm inches 14 Tag Gehwerk - 14 day time - 15 jours simple - 15 días cuerda 14 Tag Schlagwerk - 14 day strike - 15 jours sonnerie - 15 días sonería	262 = 10 mm inches



GRUPPE 1018



Lackblatt - Lacquered dial - Cadran verni - Esfera esmaltada

Rahmen - Frame - Cadre - Marco		Zifferblatt - Dial - Cadran - Esfera	
Eiche Oak Chêne Roble	Durchmesser Diameter Diamètre Diámetro	Minutenkreisdurchmesser Diameter of minute circle Diamètre du cercle minutes Diámetro del círculo de minutos	
1018/91 1018/92	54 = 21 cm inches 14 Tag Gehwerk - 14 day time - 15 jours simple - 15 días cuerda 14 Tag Schlagwerk - 14 day strike - 15 jours sonnerie - 15 días sonería	360 = 14 mm inches	
1018/93 1018/94	64 = 25 cm inches 14 Tag Gehwerk - 14 day time - 15 jours simple - 15 días cuerda 14 Tag Schlagwerk - 14 day strike - 15 jours sonnerie - 15 días sonería	445 = 17½ mm inches	



GRUPPE 1018



Lackblatt - Lacquered dial - Cadran verni - Esfera esmaltada

Rahmen - Frame - Cadre - Marco		Zifferblatt - Dial - Cadran - Esfera	
Buche hell Light beech Hêtre clair Haya color claro	Mahagonifarbig Mahogany finish Teinte acajou Color caoba	Durchmesser Diameter Diamètre Diámetro	Minutenkreisdurchmesser Diameter of minute circle Diamètre du cercle minutes Diámetro del círculo de minutos
1018/173 1018/174	1018/175 1018/176	30 = 11 3/4 cm inches	184 = 7 mm inches
		14 Tag Gehwerk - 14 day time - 15 jours simple - 15 días cuerda 14 Tag Schlagwerk - 14 day strike - 15 jours sonnerie - 15 días sonería Messinglunette - Brass bezel - Lunette laiton - Bisel de latón	
1018/169 1018/170	1018/171 1018/172	34 = 13 1/2 cm inches	225 = 9 mm inches
		14 Tag Gehwerk - 14 day time - 15 jours simple - 15 días cuerda 14 Tag Schlagwerk - 14 day strike - 15 jours sonnerie - 15 días sonería Messinglunette - Brass bezel - Lunette laiton - Bisel de latón	
1018/100 1018/101	1018/102 1018/103	38,5 = 15 cm inches	280 = 11 mm inches
		14 Tag Gehwerk - 14 day time - 15 jours simple - 15 días cuerda 14 Tag Schlagwerk - 14 day strike - 15 jours sonnerie - 15 días sonería Messinglunette - Brass bezel - Lunette laiton - Bisel de latón	



GRUPPE 1018



40,5 x 24,5 cm = 16 x 9 1/2 inches

1018/71



49 x 31 cm = 19 1/2 x 12 1/4 inches

1018/96

Lackblatt - Lacquered dial - Cadran verni - Esfera esmaltada

Rahmen - Frame - Cadre - Marco		Zifferblatt - Dial - Cadran - Esfera	
Buche hell Light beech Hêtre clair Haya color claro	Mahagonifarbig Mahogany finish Teinte acajou Color caoba	Durchmesser Diameter Diamètre Diámetro	Minutenkreisdurchmesser Diameter of minute circle Diamètre du cercle minutes Diámetro del círculo de minutos
1018/71	—	24,5 cm = 9 1/2 inches	139 mm = 5 1/2 inches
—	1018/96	31 cm = 12 1/4 inches	184 mm = 7 inches

14 Tag Schlagwerk mit Tonfeder
14 day strike - 15 jours sonnerie sur ressort timbre - 15 días sonería sobre timbre bordón



GRUPPE 1018



65 x 41 cm = 25 1/2 x 16 inches

Lackblatt - Lacquered dial - Cadran verni - Esfera esmaltada

Rahmen - Frame - Cadre - Marco		Zifferblatt - Dial - Cadran - Esfera
Nußbaum poliert Polished walnut Noyer poli Nogal pulido	Durchmesser Diameter Diamètre Diámetro	Minutenkreisdurchmesser Diameter of minute circle Diamètre du cercle minutes Diámetro del círculo de minutos
1018/42	41 cm = 16 inches	282 mm = 10 inches

Schwarze und goldfarbige Verzierungen - Black and gold coloured metal decorations
Garnitures couleur noir et or - Adornos negros y de color oro

14 Tag Schlagwerk mit Tonfeder

14 day strike - 15 jours sonnerie sur ressort timbre - 15 días sonería sobre timbre bordón



GRUPPE 1018



28 cm = 11 inches

Rahmen nußbaumfarbig, Glaszifferblatt - Frame walnut finish, glass dial - Cadre teinte noyer, cadran verre - Marco color nogal, esfera de vidrio

1018/327

8 Tag Ankergehwerk No. 239 (mit Nivarox-Spirale) - 8 day lever time movement (with Nivarox hair spring) - 8 jours simple, échappement à ancre (avec spiral Nivarox) - Máquina, 8 días cuerda, escape à ancora (con espiral Nivarox)

1036/18/327

Synchronegehwerk - Synchronous movement
Mouvement Synchron - Máquina Sincron

Rahmen Buche hell, Glaszifferblatt - Frame light beech, glass dial - Cadre hêtre clair, cadran verre - Marco haya color claro, esfera de vidrio

1018/339

8 Tag Ankergehwerk No. 239 (mit Nivarox-Spirale) - 8 day lever time movement (with Nivarox hair spring) - 8 jours simple, échappement à ancre (avec spiral Nivarox) - Máquina, 8 días cuerda, escape à ancora (con espiral Nivarox)

1036/18/339

Synchronegehwerk - Synchronous movement
Mouvement Synchron - Máquina Sincron



32 cm = 12 1/2 inches

1018/358

Nußbaumfarbig - Walnut finish - Teinte noyer - Color nogal

1018/402

Buche hell - Light beech - Hêtre clair - Haya clara

28 cm Elfenbeinglaszifferblatt - 11" glass dial, varnished dull ivory
Cadran verre beige 28 cm - Esfera de vidrio color marfil 28 cm

8 Tag Ankergehwerk - 8 day lever time movement - 8 jours simple, échappement à ancre - Máquina, 8 días cuerda, escape à ancora



33 cm = 13 inches

1018/338

Metallgehäuse verchromt, Silberblatt - Chromium plated metal case, silver dial - Boîte metal chromée, cadran argenté - Caja de metal cromada, esfera plateada

8 Tag Ankergehwerk - 8 day lever time movement - 8 jours simple, échappement à ancre - Máquina 8 días cuerda, escape à ancora

1036/18/338

Synchronegehwerk - Synchronous movement
Mouvement Synchron - Máquina Sincron



GRUPPE 1018



29 cm = 11 1/2 inches

1018/343

Metallgehäuse verchromt, Silberblatt, aufgelegte schwarze Zahlen und Zeiger, 8 Tag Ankergehwerk No. 239

Chromium plated metal case, silver dial, black raised figures and hands, 8 day lever time movement

Boîte métal chromée, cadran argenté, chiffres et aiguilles noirs en relief, mouvement 8 jours simple à ancre

Caja de metal cromada, esfera plateada, cifras y agujas negras en relieve, máquina 8 días cuerda á áncora



25 cm = 9 3/4 inches

1018/344

Elfenbein Schleiflack mit Chromrand (wandliegend), verchromte Zahlen und Zeiger 8 Tag Ankergehwerk No. 239

Ivory colour with chrome (wall fitting case), chromium plated figures and hands, 8 day lever time movement

Peinture ivoire laquée dépolie avec chromé (Pendule applique), chiffres et aiguilles chromés, mouvement 8 jours simple à ancre

Color marfil barniz pulido con arco cromado (Reloj contiguo á la pared), cifras y agujas cromadas, máquina 8 días cuerda á áncora



GRUPPE 1018



19 x 25,5 cm = 7 1/2 x 10 inches

1018/437

Elfenbeinfarbig, braun gedruckte Zahlen, 8 Tag Pendelgehwerk No. 52

Ivory colour, brown printed figures, 8 day pendulum time movement

Beige, chiffres imprimés bruns, mouvement 8 jours simple à balancier

Color marfil, cifras morenas impresas, máquina 8 días cuerda á péndula



19 x 25,5 cm = 7 1/2 x 10 inches

1018/438

Elfenbeinfarbig mit Birkeeinlage, vernickelte Zahlen und Zeiger, 8 Tag Pendelgehwerk No. 52

Ivory colour with real birch, nickelled figures and hands, 8 day pendulum time movement

Beige avec bouleau véritable, chiffres et aiguilles nickelés, mouvement 8 jours simple à balancier

Color marfil con incrustación de abedul, cifras y agujas niqueladas, máquina 8 días cuerda á péndula



19 x 25,5 cm = 7 1/2 x 10 inches

1018/439

Elfenbeinfarbig mit vernickelter Metalleinlage, vernickelte Zahlen und Zeiger, 8 Tag Pendelgehwerk No. 52

Ivory colour with nickelled, nickelled figures and hands, 8 day pendulum time movement

Beige avec nickelé, chiffres et aiguilles nickelés, mouvement 8 jours simple à balancier

Color marfil con niquelado, cifras y agujas niqueladas, máquina 8 días cuerda á péndula

1036/18/439

Synchronegehwerk - Synchronous movement - Mouvement Synchron - Máquina Sincron



GRUPPE 1018

1018/440

Elfenbeinfarbig mit verchromter Metalleinlage, 16 cm Chromlunette, Silberzahlenreif, 8 Tag Pendelgehwerk No. 52

Ivory colour with chromium, chromium plated bezel, 8 1/4 inches, silvered figure-circle, 8 day pendulum time movement



19 x 25,5 cm = 7 1/2 x 10 inches

Beige avec chromé, lunette chromée, 16 cm, cercle à chiffres argenté, mouvement 8 jours simple à balancier

Color marfil y cromado, bisel cromado, 16 cm, cerco de cifras plateado, máquina 8 días cuerda á péndula

1018/385

Elfenbein mit echt Birke, vernickelte Zahlen und Zeiger, 8 Tag Pendelgehwerk No. 52

Ivory colour with real birch, nickelled figures and hands, 8 day pendulum time movement



21 x 29 cm = 8 1/4 x 11 1/2 inches

Beige avec véritable bouleau, chiffres et aiguilles nickelés, mouvement 8 jours simple à balancier

Color marfil con abedul genuino, cifras y agujas niqueladas, máquina 8 días cuerda á péndula

1018/386

Elfenbein mit echt Birke, Chromausstattung, 8 Tag Pendelgehwerk No. 52

Ivory colour with real birch, chromium plated fittings, 8 day pendulum time movement



21 x 29 cm = 8 1/4 x 11 1/2 inches

Beige avec véritable bouleau, garniture chromée, mouvement 8 jours simple à balancier

Color marfil con abedul genuino, equipo cromado, máquina 8 días cuerda á péndula



GRUPPE 1018

1018/453

Elfenbeinfarbig, polierte Metallzahlen, Zeiger und Minutenkreis, 8 Tag Ankergehwerk No. 239

Ivory colour, polished figures, hands and circle, 8 day lever time movement



21 x 29 cm = 8 1/4 x 11 1/2 inches

Beige, chiffres, aiguilles et cercle polis, mouvement 8 jours simple à ancre

Color marfil, cifras, agujas y cerco pulido, máquina 8 días cuerda á áncora

1018/450

Elfenbeinfarbig mit Caramelseiten, 18 cm Goldlunette, vergoldeter Zahlenreif, 8 Tag Ankergehwerk No. 239

Ivory colour with caramel, gilt bezel, 7 inches, gilt figure-circle, 8 day lever time movement



21 x 29 cm = 8 1/4 x 11 1/2 inches

Beige avec caramel, lunette dorée, 18 cm, cercle à chiffres doré, mouvement 8 jours simple à ancre

Color marfil con caramel, bisel dorado, 18 cm, cerco de cifras dorado, máquina 8 días cuerda á áncora

1036/18/450

Synchronegehwerk - Synchronous movement - Mouvement Synchron - Máquina Sincron

1018/451

Elfenbein mit echt Birke, 18 cm Goldlunette, vergoldeter Zahlenreif, 8 Tag Ankergehwerk No. 239

Ivory colour with real birch, gilt bezel, 7 inches, gilt figure-circle, 8 day lever time movement



21 x 29 cm = 8 1/4 x 11 1/2 inches

Beige avec véritable bouleau, lunette dorée, 18 cm, cercle à chiffres doré, mouvement 8 jours simple à ancre

Color marfil con abedul genuino, bisel dorado, 18 cm, cerco de cifras dorado, máquina 8 días cuerda á áncora

1036/18/451

Synchronegehwerk - Synchronous movement - Mouvement Synchron - Máquina Sincron



GRUPPE 1018



25 x 30 cm = 9 7/8 x 11 3/4 inches

1018/448

Elfenbeinfarbig, braune Zahlen und Zeiger unter Glas, 8 Tag Ankergehwerk No. 239

Ivory colour, brown figures and hands under glass, 8 day lever time movement

Beige, chiffres et aiguilles bruns sous verre, mouvement 8 jours simple à ancre

Color marfil, cifras y agujas morenas bajo vidrio, máquina 8 días cuerda à âncora



21 x 29 cm = 8 1/4 x 11 3/4 inches

1018/458

Nußbaum hell, feinmatt, 18 cm Goldlunette, vergoldeter Zahlenreif, 8 Tag Ankergehwerk No. 239

Light walnut, mat, gilt bezel, 7 inches, gilt figure-circle, 8 day lever time movement

Noyer clair, mat, lunette dorée, 18 cm, cercle à chiffres doré, mouvement 8 jours simple à ancre

Nogal claro, mate, bisel dorado, 18 cm, cerco de cifras dorado, máquina 8 días cuerda à âncora

1036/18/458

Synchronegehwerk - Synchronous movement - Mouvement Synchron - Máquina Sincron



GRUPPE 1019

Küchenuhren in Keramik

Kitchen and Nursery Clocks, earthenware plates and cases - Pendules pour cuisine en faïence
Relojes para cocina en loza

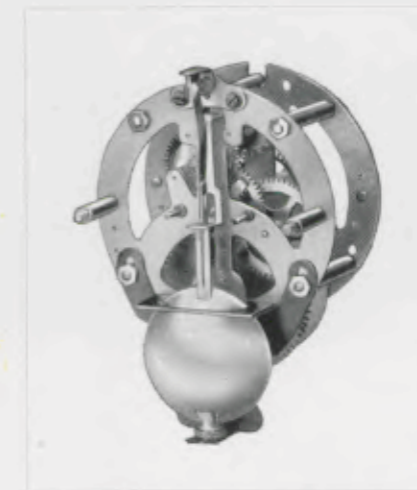

No. 52

8 Tag Pendelgehwerk, schweres Pendel, mit einfacher und sicherer Transportbefestigung

8 day pendulum time movement, heavy pendulum, simple and securely fastened for transport

Mouvement 8 jours simple balancier, balancier lourd, simple et sûrement attaché pour éviter tout dégât

Máquina 8 días cuerda à péndula, péndula pesada, simple y seguramente atado impidiéndole causar daños

Platinen - Plates - Platines - Platinas
6,5 x 6,5 cm = 2 1/2 x 2 1/2 inches

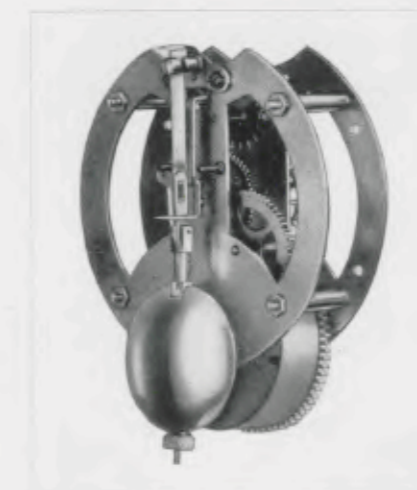

No. 247

8 Tag flaches Pendelgehwerk, schweres Pendel, mit einfacher und sicherer Transportbefestigung

8 day pendulum time movement, heavy pendulum, simple and securely fastened for transport

Mouvement 8 jours simple à balancier, balancier lourd, simple et sûrement attaché pour éviter tout dégât

Máquina 8 días cuerda à péndula, péndula pesada, simple y seguramente atado impidiéndole causar daños

Platinen - Plates - Platines - Platinas
7,8 x 7,8 cm = 3 1/4 x 3 1/4 inches



GRUPPE 1019

Küchenuhren in Keramik

Kitchen and Nursery Clocks, earthenware plates - Pendules pour cuisine en faïence
Relojes para cocina en loza

1019/441

1 Tag Ankergehwerk No. 6

1 day lever time movement
Mouvement 30 heures simple à ancre

Máquina 30 horas cuerda à âncora

1019/442

8 Tag Pendelgehwerk No. 52

8 day pendulum time movement
Mouvement 8 jours simple à balancier

Máquina 8 días cuerda à péndula



19 x 21,5 cm = 7 1/2 x 8 1/2 inches

Steingutplatte elfenbeinfarbig mit blauen Linien

Ivory colour earthenware plate with blue lines

Assiette en faïence beige avec filets bleus

Plato de loza color marfil con líneas azules

1019/443

1 Tag Ankergehwerk No. 6

1 day lever time movement
Mouvement 30 heures simple à ancre

Máquina 30 horas cuerda à âncora

1019/444

8 Tag Pendelgehwerk No. 52

8 day pendulum time movement
Mouvement 8 jours simple à balancier

Máquina 8 días cuerda à péndula



19 x 21,5 cm = 7 1/2 x 8 1/2 inches

Steingutplatte elfenbeinfarbig mit Goldlinien

Ivory colour earthenware plate with gilt lines

Assiette en faïence beige avec filets dorés

Plato de loza color marfil con líneas doradas

1019/445

1 Tag Ankergehwerk No. 6

1 day lever time movement
Mouvement 30 heures simple à ancre

Máquina 30 horas cuerda à âncora

1019/446

8 Tag Pendelgehwerk No. 52

8 day pendulum time movement
Mouvement 8 jours simple à balancier

Máquina 8 días cuerda à péndula



19 x 21,5 cm = 7 1/2 x 8 1/2 inches

Steingutplatte elfenbeinfarbig mit Birke

Ivory colour earthenware plate with birch

Assiette en faïence beige avec bouleau

Plato de loza color marfil con abedul



GRUPPE 1019

Küchenuhren in Keramik

Kitchen and Nursery Clocks, earthenware plates - Pendules pour cuisine en faïence
Relojes para cocina en loza



20 x 25 cm = 7 1/4 x 9 7/8 inches

1019/590

Steingutplatte elfenbeinfarbig mit Birke, 8 Tag Pendelgehwerk No. 52

Ivory colour earthenware plate with birch, 8 day pendulum time movement

Assiette en faïence beige avec bouleau, mouvement 8 jours simple à balancier

Plato de loza color marfil con abedul, máquina 8 días cuerda à péndula

1036/19/590

Synchrongehwerk - Synchronous movement
Mouvement Synchron - Máquina Sincron



20 x 25 cm = 7 1/4 x 9 7/8 inches

1019/591

Steingutplatte elfenbeinfarbig mit Birke, 17 cm Chromlunette, 8 Tag Pendelgehwerk No. 52

Ivory colour earthenware plate with birch, chromium plated bezel, 6 3/4 inches, 8 day pendulum time movement

Assiette en faïence beige avec bouleau, lunette chromée, 17 cm, mouvement 8 jours simple à balancier

Plato de loza color marfil con abedul, bisel cromado, 17 cm, máquina 8 días cuerda à péndula



20 x 25 cm = 7 1/4 x 9 7/8 inches

1019/592

Steingutplatte elfenbeinfarbig mit Birke, 8 Tag Pendelgehwerk No. 52

Ivory colour earthenware plate with birch, 8 day pendulum time movement

Assiette en faïence beige avec bouleau, mouvement 8 jours simple à balancier

Plato de loza color marfil con abedul, máquina 8 días cuerda à péndula



20 x 25 cm = 7 1/4 x 9 7/8 inches

1019/593

Steingutplatte elfenbeinfarbig mit Goldlinie, 8 Tag Pendelgehwerk No. 52

Ivory colour earthenware plate with gilt line, 8 day pendulum time movement

Assiette en faïence beige avec filet or, mouvement 8 jours simple à balancier

Plato de loza color marfil con línea dorada, máquina 8 días cuerda à péndula



GRUPPE 1019

Küchenuhren in Keramik

Kitchen and Nursery Clocks, earthenware plates - Pendules pour cuisine en faïence
Relojes para cocina en loza



20 x 25 cm = 7 7/8 x 9 7/8 inches

1019/594

Steingutplatte elfenbeinfarbig, 17 cm Chromlunette,
8 Tag Pendelgehwerk No. 52

Ivory colour earthenware plate, chromium plated bezel,
6 3/4 inches, 8 day pendulum time movement

Assiette en faïence beige, lunette chromée, 17 cm,
mouvement 8 jours simple à balancier

Plato de loza color marfil, bisel cromado, 17 cm,
máquina 8 días cuerda a péndula

1036/19/594

Synchronegehwerk - Synchronous movement
Mouvement Synchron - Máquina Sincron



22 x 26 cm = 8 5/8 x 10 1/4 inches

1019/595

Steingutplatte elfenbeinfarbig mit Caramel,
8 Tag Pendelgehwerk No. 52

Ivory colour earthenware plate with caramel,
8 day pendulum time movement

Assiette en faïence beige avec caramel,
mouvement 8 jours simple à balancier

Plato de loza color marfil con caramel,
máquina 8 días cuerda a péndula



GRUPPE 1019

Küchenuhren in Keramik

Kitchen and Nursery Clocks, earthenware plates - Pendules pour cuisine en faïence
Relojes para cocina en loza



21 x 28 cm = 8 1/4 x 11 inches

1019/598

Steingutplatte elfenbeinfarbig mit Goldlinien,
18 cm Goldlunette, 8 Tag Pendelgehwerk No. 52

Ivory colour earthenware plate with gilt lines, gilt bezel,
7 inches, 8 day pendulum time movement

Assiette en faïence beige avec filets or, lunette dorée,
18 cm, mouvement 8 jours simple à balancier

Plato de loza color marfil con líneas doradas,
bisel dorado, 18 cm, máquina 8 días cuerda a péndula



21 x 28 cm = 8 1/4 x 11 inches

1019/599

Steingutplatte elfenbeinfarbig mit Chromlinien,
18 cm Chromlunette, 8 Tag Pendelgehwerk No. 52

Ivory colour earthenware plate with chromium lines,
chromium bezel, 7 inches, 8 day pendulum time movement

Assiette en faïence beige avec filets chromés, lunette chromée,
18 cm, mouvement 8 jours simple à balancier

Plato de loza color marfil con líneas cromadas,
bisel cromado, 18 cm, máquina 8 días cuerda a péndula



22 x 26 cm = 8 5/8 x 10 1/4 inches

1019/596

Steingutplatte elfenbeinfarbig mit blau,
8 Tag Pendelgehwerk No. 52

Ivory colour earthenware plate with blue,
8 day pendulum time movement

Assiette en faïence beige avec bleu,
mouvement 8 jours simple à balancier

Plato de loza color marfil con azul,
máquina 8 días cuerda a péndula



21 x 28 cm = 8 1/4 x 11 inches

1019/597

Steingutplatte elfenbeinfarbig mit Goldlinien,
8 Tag Pendelgehwerk No. 52

Ivory colour earthenware plate with gilt lines,
8 day pendulum time movement

Assiette en faïence beige avec filets or,
mouvement 8 jours simple à balancier

Plato de loza color marfil con líneas doradas,
máquina 8 días cuerda a péndula



21 x 28 cm = 8 1/4 x 11 inches

1019/600

Steingutplatte elfenbeinfarbig,
8 Tag Pendelgehwerk No. 52

Ivory colour earthenware plate,
8 day pendulum time movement

Assiette en faïence beige,
mouvement 8 jours simple à balancier

Plato de loza color marfil,
máquina 8 días cuerda a péndula



21 x 28 cm = 8 1/4 x 11 inches

1019/601

Steingutplatte elfenbeinfarbig mit Birke,
8 Tag Pendelgehwerk No. 52

Ivory colour earthenware plate with birch,
8 day pendulum time movement

Assiette en faïence beige avec bouleau,
mouvement 8 jours simple à balancier

Plato de loza color marfil con abedul,
máquina 8 días cuerda a péndula

1036/19/601

Synchronegehwerk - Synchronous movement
Mouvement Synchron - Máquina Sincron



GRUPPE 1019

Küchenuhren in Keramik

Kitchen and Nursery Clocks, earthenware - Pendules pour cuisine en faïence
Relojes para cocina en loza



21 x 28 cm = 8 1/4 x 11 inches

1019/602

Steingutplatte elfenbeinfarbig,
8 Tag Pendelgehwerk No. 247

Ivory colour earthenware plate,
8 day pendulum time movement
Assiette en faïence beige,
mouvement 8 jours simple à balancier
Plato de loza color marfil,
máquina 8 días cuerda a péndula

1036/19/602

Synchronegehwerk - Synchronous movement
Mouvement Synchron - Máquina Sincron



24 x 24 cm = 9 1/2 x 9 1/2 inches

1019/603

Steingutplatte elfenbeinfarbig, chrompolierte Relief-
zahlen aus Steingut, 8 Tag Pendelgehwerk No. 247

Ivory colour earthenware plate, raised polished chromi-
um plated earthenware figures, 8 day pendulum time
movement

Assiette en faïence beige, chiffres en faïence relief
chromés polis, mouvement 8 jours simple à balancier
Plato de loza color marfil, cifras en relieve de loza
cromadas y pulidas, máquina 8 días cuerda a péndula

1036/19/603

Synchronegehwerk - Synchronous movement
Mouvement Synchron - Máquina Sincron



23 x 28 cm = 9 x 11 inches

1019/604

Steingutgehäuse elfenbeinfarbig mit Birke,
8 Tag Pendelgehwerk No. 247

Ivory colour earthenware case with birch,
8 day pendulum time movement
Cage en faïence beige avec bouleau,
mouvement 8 jours simple à balancier
Caja de loza color marfil con abedul,
máquina 8 días cuerda a péndula



23 x 28 cm = 9 x 11 inches

1019/605

Steingutgehäuse elfenbeinfarbig mit Goldlinie,
8 Tag Pendelgehwerk No. 247

Ivory colour earthenware case with gilt line,
8 day pendulum time movement
Cage en faïence beige avec filet doré,
mouvement 8 jours simple à balancier
Caja de loza color marfil con línea dorada,
máquina 8 días cuerda a péndula



GRUPPE 1019

Küchenuhren in Keramik

Kitchen and Nursery Clocks in earthenware - Pendules pour cuisine en faïence
Relojes para cocina en loza



20 x 30 cm = 7 7/8 x 11 3/4 inches

1019/606

Steingutgehäuse elfenbeinfarbig mit Caramel, 18 cm Goldlunette, 8 Tag Pendelgehwerk No. 247

Ivory colour earthenware case with caramel, gilt bezel, 7 inches, 8 day pendulum time movement
Cage en faïence beige avec caramel, lunette dorée, 18 cm, mouvement 8 jours simple à balancier
Caja de loza color marfil con caramel, bisel dorado, 18 cm, máquina 8 días cuerda a péndula

1036/19/606

Synchronegehwerk - Synchronous movement - Mouvement Synchron - Máquina Sincron



20 x 30 cm = 7 7/8 x 11 3/4 inches

1019/607

Elfenbeinfarbiges Steingutgehäuse, 18 cm Chromlunette, 8 Tag Pendelgehwerk No. 247

Ivory colour earthenware case, chromium plated bezel, 7 inches, 8 day pendulum time movement
Cage en faïence beige, lunette chromée, 18 cm, mouvement 8 jours simple à balancier
Caja de loza color marfil, bisel cromado, 18 cm, máquina 8 días cuerda a péndula

GRUPPE 1021

Regulateure

Regulators - Régulateurs - Reguladores



68 x 27 cm = 26 3/4 x 10 1/2 inches

1021/12

Auch mit Adleraufsatz lieferbar
Also with eagle instead of horse
Livvable aussi avec aigle au lieu du cheval
Se suministra también con aderezo de águila

Zelluloidblatt - Celluloid dial - Cadran celluloid - Esfera de celuloide
12,6 cm = 5 inches 14,5 cm = 5 3/4 inches

Nußbaum poliert, 14 Tag Schlagwerk
Polished walnut, 14 day strike - Noyer poli, 15 jours sonnerie - Nogal pulido, 15 días soneria



89,5 x 35 cm = 34 1/2 x 13 3/4 inches

1021/32

GRUPPE 1021

Regulateure

Regulators - Régulateurs - Reguladores



108 x 39 cm = 42 1/2 x 15 1/4 inches

1021/53

Nußbaum poliert, 14 Tag Schlagwerk
Polished walnut, 14 day strike - Noyer poli, 15 jours sonnerie - Nogal pulido, 15 días soneria

Glasseiten - Glass sides - Côtés en verre - Lados en vidrio

Auch mit Adleraufsatz lieferbar - Also with eagle instead of horse
Livvable aussi avec aigle au lieu du cheval - Se suministra también con aderezo de águila
Zelluloidblatt - Celluloid dial - Cadran celluloid - Esfera de celuloide 14,5 cm = 5 3/4 inches



GRUPPEN 1023, 1024, 1025

Wanduhren

Regulators - Régulateurs - Reguladores

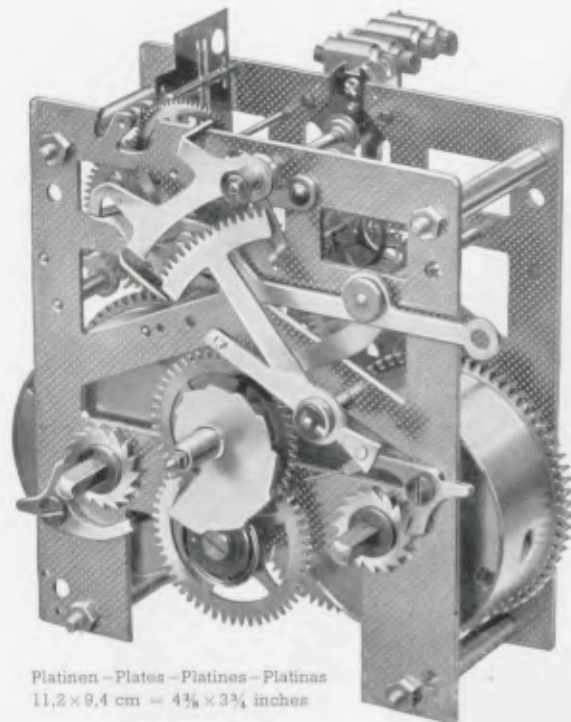

Platinen - Plates - Platines - Platinas
11,2 x 9,4 cm = 4 3/8 x 3 3/4 inches

No. 277

14 Tag Halbstund-Rechenschlagwerk auf Gong und „Bim Bam“ - Herausnehmbare Federhäuser

14 day half-hour rack-strike movement on Gong and „Bim Bam“ - Interchangeable spring barrels

Mouvement à râtelier 15 jours sonnerie heures et demies sur Gong et „Bim Bam“ - Barillets interchangeables

Máquina á sierra 15 días sonería horas y medias sobre Gong y „Bim Bam“ - Barriletes intercambiables

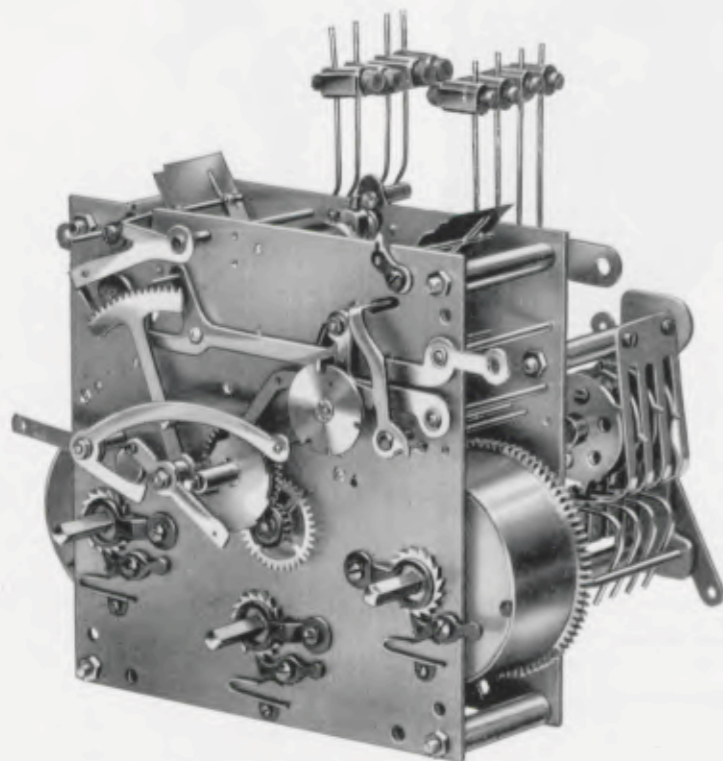

Platinen - Plates - Platines - Platinas
123 x 123 mm = 4 7/8 x 4 7/8 inches

No. 64

8 Tag 1/4 Westminster-Schlagwerk No. 64 mit 4 Stäben

8 day 1/4 Westminster chime movement No. 64 with 4 rod gongs

8 jours sonnerie 1/4 Carillon Westminster sur 4 tiges, mouvement No. 64

8 días sonería 1/4 Carillon Westminster sobre 4 varillas, máquina No. 64



GRUPPE 1023

Wanduhren

Wall clocks - Régulateurs - Reguladores



49 x 23,5 cm = 19 1/4 x 9 1/4 inches

1023/79

Nußbaumfarbig - Walnut finish - Teinte noyer - Color nogal

Metallblatt - Metal dial - Cadran métal - Esfera de metal 15 cm = 6 inches

8 Tag Halbstund-Schlagwerk, Tonfeder - Stabgong - Bachgong

8 day 1/2 hour strike, plain strike - Rod gong - Gong „Bim Bam“

8 jours sonnerie heures et demies, ressort timbre - Gong tige - Gong „Bim Bam“

8 días sonería horas y medias, sonería sobre bordón - Sonería sobre gong tija - Gong „Bim Bam“



GRUPPE 1023

Wanduhren

Wall clocks - Régulateurs - Reguladores



54,5 x 25,5 cm = 21 1/4 x 10 inches

1023/88

Eiche - Oak - Chêne - Roble

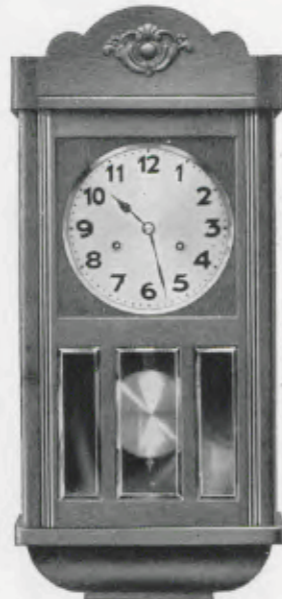

54,5 x 25,5 cm = 21 1/4 x 10 inches

1023/90

Eiche - Oak - Chêne - Roble



54,5 x 25,5 cm = 21 1/4 x 10 inches

1023/92

Eiche - Oak - Chêne - Roble

14 Tag Halbstund-Schlagwerk, Tonfeder - Stabgong - Bachgong

14 day 1/2 hour strike, plain strike - Rod gong - Gong „Bim Bam“

15 jours sonnerie heures et demies, ressort timbre - Gong tige - Gong „Bim Bam“

15 días sonería horas y medias, sonería sobre bordón - Sonería sobre gong tija - Gong „Bim Bam“

Metallblatt - Metal dial - Cadran métal - Esfera de metal 15 cm = 6 inches

In allen Eichenfarben lieferbar - Can be had in all oak colours

Livrables en toutes teintes de chêne - Se hacen las cajas en todos los colores de roble



GRUPPE 1024

Wanduhren

Wall clocks - Régulateurs - Reguladores



55 x 28 cm = 21 1/4 x 11 inches

1024/127

Eiche - Oak - Chêne - Roble



55 x 28 cm = 21 1/4 x 11 inches

1024/128

Eiche - Oak - Chêne - Roble



55 x 28 cm = 21 1/4 x 11 inches

1024/129

Eiche - Oak - Chêne - Roble

8 Tag Halbstund-Schlagwerk, Tonfeder oder Bachgong

8 day 1/2 hour strike, plain Gong or „Bim Bam“

8 jours sonnerie heures et demies, ressort timbre ou Gong „Bim Bam“

8 días sonería horas y medias, sonería sobre bordón ó sonería sobre Gong „Bim Bam“

Metallblatt - Metal dial - Cadran métal - Esfera de metal 18 cm = 7 inches

In allen Eichenfarben lieferbar - Can be had in all oak colours

Livrables en toutes teintes de chêne - Se hacen las cajas en todos los colores de roble



GRUPPE 1024
Wanduhren
Wall clocks - Régulateurs - Reguladores



57 x 29 cm = 22 1/2 x 11 1/2 inches

1024/207

Eiche - Oak - Chêne - Roble



57 x 29 cm = 22 1/2 x 11 1/2 inches

1024/208

Eiche - Oak - Chêne - Roble



57 x 29 cm = 22 1/2 x 11 1/2 inches

1024/209

Eiche - Oak - Chêne - Roble

8 Tag Halbstund-Schlagwerk, Tonfeder oder Bachgong

8 day 1/2 hour strike, plain Gong or „Bim Bam“

8 jours sonnerie heures et demies, ressort timbre ou Gong „Bim Bam“

8 días sonería horas y medias, sonería sobre bordón ó sonería sobre Gong „Bim Bam“

Metallblatt - Metal dial - Cadran métal - Esfera de metal 18 cm = 7 inches

In allen Eichenfarben Lieferbar - Can be had in all oak colours

Livrables en toutes teintes de chêne - Se hacen las cajas en todos los colores de roble



GRUPPE 1024
Wanduhren
Wall clocks - Régulateurs - Reguladores



57 x 29 cm = 22 1/2 x 11 1/2 inches

1024/210

Eiche - Oak - Chêne - Roble



57 x 29 cm = 22 1/2 x 11 1/2 inches

1024/211

Eiche - Oak - Chêne - Roble



57 x 29 cm = 22 1/2 x 11 1/2 inches

1024/212

Eiche - Oak - Chêne - Roble

1024/213

Nußbaum - Walnut
Noyer - Nogal

8 Tag Halbstund-Schlagwerk, Tonfeder oder Bachgong

8 day 1/2 hour strike, plain Gong or „Bim Bam“

8 jours sonnerie heures et demies, ressort timbre ou Gong „Bim Bam“

8 días sonería horas y medias, sonería sobre bordón ó sonería sobre Gong „Bim Bam“

Metallblatt - Metal dial - Cadran métal - Esfera de metal 18 cm = 7 inches

Eichengehäuse in allen Eichenfarben Lieferbar - Oak cases can be had in all oak colours

Les cages chêne se livrent en toutes teintes de chêne - Se hacen las cajas en todos los colores de roble

**Messing-Verglasungen**

für die No. 1024/115, 116, 153, 154

Brass fittings for No. 1024/115, 116, 153, 154 - Panneaux de glaces en laiton pour les nos. 1024/115, 116, 153, 154

Vidrieras en latón para los nos. 1024/115, 116, 153, 154

273



274

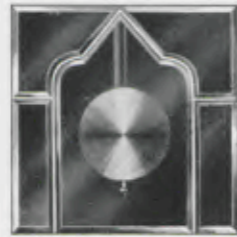

275

**Chrom-Verglasungen**

für die No. 1024/115, 116, 153, 154

Chromium plated fittings for No. 1024/115, 116, 153, 154 - Panneaux de glaces chromés pour les nos. 1024/115, 116, 153, 154

Vidrieras cromadas para los nos. 1024/115, 116, 153, 154

273 C

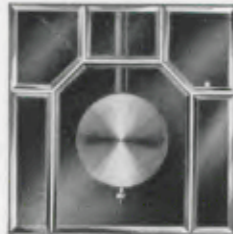

275 C

**GRUPPE 1024**

Wanduhren

Wall clocks - Régulateurs - Reguladores



61 x 29 cm - 24 x 11 1/2 inches

1024/131

Eiche, gewöhnliche Gläser - Oak, plain glasses - Chêne, verres simples - Roble, vidrios ordinarios

1024/132

Eiche, Facettegläser - Oak, bevelled glasses - Chêne, glaces biseautées - Roble, cristales biselados**8 Tag Halbstund-Schlagwerk, Waldgong - Bachgong** - 1/4, Westminsterschlag

8 day 1/2 hour strike, Waldgong - Gong „Bim Bam“ - 1/4, Westminster chime

8 jours sonnerie heures et demies, Waldgong - Gong „Bim Bam“ - 1/4, Carillon Westminster

8 días sonería horas y medias, sonería sobre Waldgong - Gong „Bim Bam“ - 1/4, Carillon Westminster

In allen Eichenfarben Lieferbar - Can be had in all oak colours

Livrables en toutes teintes de chêne - Se hacen las cajas en todos los colores de roble

Zifferblatt - Dial - Cadran - Esfera 18 cm - 7 inches

61 x 29 cm - 24 x 11 1/2 inches

1024/133

Eiche - Oak - Chêne - Roble

GRUPPE 1024

Wanduhren

Wall clocks - Régulateurs - Reguladores



63,5 x 31,5 cm = 25 x 12 3/4 inches

1024/111

Eiche - Oak - Chêne - Roble
Gewöhnliche Gläser - Plain glasses -
Verres simples - Vidrios ordinarios

1024/113

Eiche - Oak - Chêne - Roble
Facettegläser - Bevelled glasses -
Glaces biseautées - Cristales biselados

Waldgong - Bachgong - 1/4 Westminsterschlag

Waldgong - Gong „Bim Bam“ - 1/4 Westminster chime
Waldgong - Gong „Bim Bam“ - 1/4 Carillon Westminster
Waldgong - Gong „Bim Bam“ - 1/4 Carillon Westminster

Eichengehäuse in allen Eichenfarben lieferbar - Oak cases can be had in all oak colours
Les cages chêne se livrent en toutes teintes de chêne - Se hacen las cajas en todos los colores de roble

Zifferblatt - Dial - Cadran - Esfera 18 cm = 7 inches



63,5 x 31,5 cm = 25 x 12 3/4 inches

1024/115

Eiche - Oak - Chêne - Roble

1024/116

Nußbaum - Walnut - Noyer - Nogal

GRUPPE 1024

Wanduhren

Wall clocks - Régulateurs - Reguladores



63,5 x 31,5 cm = 25 x 12 1/2 inches

1024/152

Eiche, Facettegläser - Oak, bevelled
glasses - Chêne, glaces biseautées -
Roble, cristales biselados

Waldgong - Bachgong - 1/4 Westminsterschlag

Waldgong - Gong „Bim Bam“ - 1/4 Westminster chime
Waldgong - Gong „Bim Bam“ - 1/4 Carillon Westminster
Waldgong - Gong „Bim Bam“ - 1/4 Carillon Westminster

Eichengehäuse in allen Eichenfarben lieferbar - Oak cases can be had in all oak colours
Les cages chêne se livrent en toutes teintes de chêne - Se hacen las cajas en todos los colores de roble

Zifferblatt - Dial - Cadran - Esfera 18 cm = 7 inches



63,5 x 31,5 cm = 25 x 12 1/2 inches

1024/153

Eiche - Oak - Chêne - Roble

1024/154

Nußbaum - Walnut - Noyer - Nogal



GRUPPE 1024

Wanduhren

Wall clocks - Régulateurs - Reguladores



63,5 x 33,5 cm = 25 x 13 1/4 inches

1024/214

Eiche - Oak - Chêne - Roble



63,5 x 33,5 cm = 25 x 13 1/4 inches

1024/215

Eiche - Oak - Chêne - Roble



63,5 x 33,5 cm = 25 x 13 1/4 inches

1024/216

Eiche - Oak - Chêne - Roble

1024/217

Nußbaum - Walnut - Noyer - Nogal

Waldgong - Bachgong - 1/4 Westminsterschlag

Waldgong - Gong „Bim Bam“ - 1/4 Westminster chime

Waldgong - Gong „Bim Bam“ - 1/4 Carillon Westminster*

Waldgong - Gong „Bim Bam“ - 1/4 Carillon Westminster

Eichengehäuse in allen Eichenfarben lieferbar - Oak cases can be had in all oak colours

Les cages chêne se livrent en toutes teintes de chêne - Se hacen las cajas en todos los colores de roble

20 cm - 8" Metallblatt - 8" metal dial - Cadran métal 20 cm - Esfera de metal 20 cm



GRUPPE 1024

Wanduhren

Wall clocks - Régulateurs - Reguladores



64 x 32,5 cm = 25 1/4 x 12 3/4 inches

1024/218

Nußbaum - Walnut - Noyer - Nogal

14 Tag 1/2 Stund-Schlagwerk, Waldgong - Bachgong - 1/4 Westminsterschlag

14 day 1/2 hour strike, Waldgong - Gong „Bim Bam“ - 1/4 Westminster chime

15 jours sonnerie heures et demies, Waldgong - Gong „Bim Bam“ - 1/4 Carillon Westminster

15 días sonería, horas y medias, sonería sobre Waldgong - Gong „Bim Bam“ - 1/4 Carillon Westminster

Metallblatt - Metal dial - Cadran métal - Esfera de metal 20 cm - 8 inches



57 x 29 cm = 22 1/2 x 11 1/2 inches

1024/219

Eiche mit Nußbaum, 8 Tag 1/2 Stund-Schlagwerk, Tonfeder oder Bachgong

Oak with walnut, 8 day 1/2 hour strike, plain Gong or „Bim Bam“

Chêne avec noyer, 8 jours sonnerie heures et demies, ressort timbre ou Gong „Bim Bam“

Roble con nogal, 8 días sonería, horas y medias, sonería sobre bordón ó sonería sobre Gong „Bim Bam“

Metallblatt - Metal dial - Cadran métal - Esfera de metal 18 cm - 7 inches



62,5 x 33,5 cm = 24 3/4 x 13 1/4 inches

1024/220

Eiche - Oak - Chêne - Roble

14 Tag 1/2 Stund-Schlagwerk, Einstabgong - Bachgong

14 day 1/2 hour strike, rod gong Gong „Bim Bam“

15 jours sonnerie heures et demies, Gong tige - Gong „Bim Bam“

15 días sonería, horas y medias, Gong tija - Gong „Bim Bam“

Metallblatt - Metal dial - Cadran métal - Esfera de metal 20 cm - 8 inches

Eichengehäuse in allen Eichenfarben lieferbar - Oak cases can be had in all oak colours

Les cages chêne se livrent en toutes teintes de chêne - Se hacen las cajas en todos los colores de roble



GRUPPE 1025

Wanduhren

Wall clocks - Régulateurs - Reguladores

15

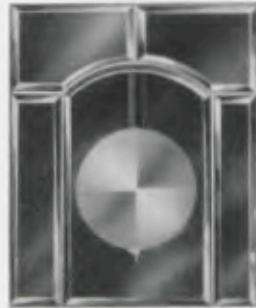

44

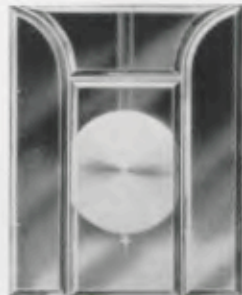

93

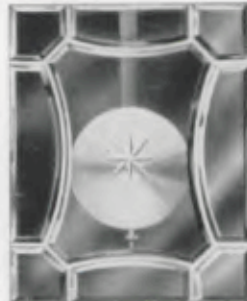

147

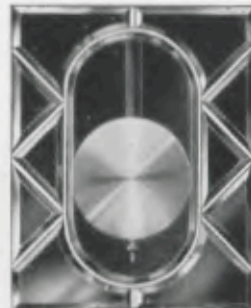

188

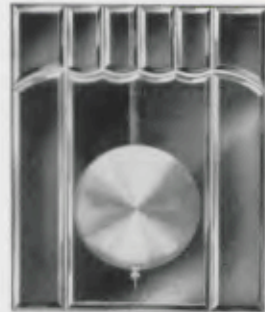

257

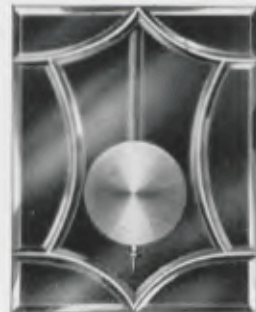

258

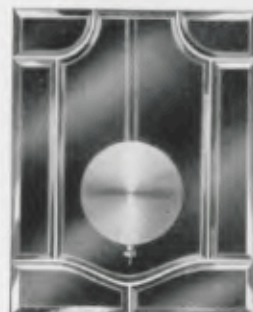

259



260



261



262



Die Regulatoren der Gruppe 1025 mit rechteckigen Verglasungen können auch mit den hier abgebildeten Messingverglasungen geliefert werden, No. 147, 258-261 auch in Chrom

The regulators of group 1025 fitted with rectangular brass frames can also be had with the above shown fittings, No. 147, 258-261 also chromium plated

Les régulateurs de la série 1025 avec panneaux de glaces carrées peuvent être fournis avec les panneaux de glaces serties en laiton suivant gravures ci-dessus. Les numéros 147, 258-261 peuvent être demandés aussi en chromés. Los reguladores del grupo 1025 con vidrieras rectangulares se suministran además con las vidrieras de los dibujos, que se ven más arriba. Se pueden pedir los números 147, 258-261 también cromados



GRUPPE 1025

Wanduhren

Wall clocks - Régulateurs - Reguladores



78 x 33 cm = 30 3/4 x 13 inches

1025/466

Eiche - Oak - Chêne - Roble

1025/467

Nußbaum - Walnut - Noyer - Nogal
Gewöhnliche Gläser - Plain glasses -
Verres simples - Vidrios ordinarios

1025/468

Eiche - Oak - Chêne - Roble

1025/469

Nußbaum - Walnut - Noyer - Nogal
Facettegläser - Bevelled glasses -
Glases bisautées - Cristales biselados

Waldgong - Bachgong - 1/4 Westminsterschlag

Waldgong - Gong „Bim Bam“ - 1/4 Westminster chime

Waldgong - Gong „Bim Bam“ - 1/4 Carillon Westminster

Soneria sobre Waldgong - Gong „Bim Bam“ - 1/4 Carillon Westminster

Eichengehäuse in allen Eichenfarben lieferbar - Oak cases can be had in all oak colours

Les cages chêne se livrent en toutes teintes de chêne - Se hacen las cajas en todos los colores de roble

Zifferblatt - Dial - Cadran - Esfera 18 cm = 7 inches



79 x 33 cm = 30 3/4 x 13 inches

1025/470

Eiche - Oak - Chêne - Roble

1025/471

Nußbaum - Walnut - Noyer - Nogal



GRUPPE 1025

Wanduhren

Wall clocks - Régulateurs - Reguladores

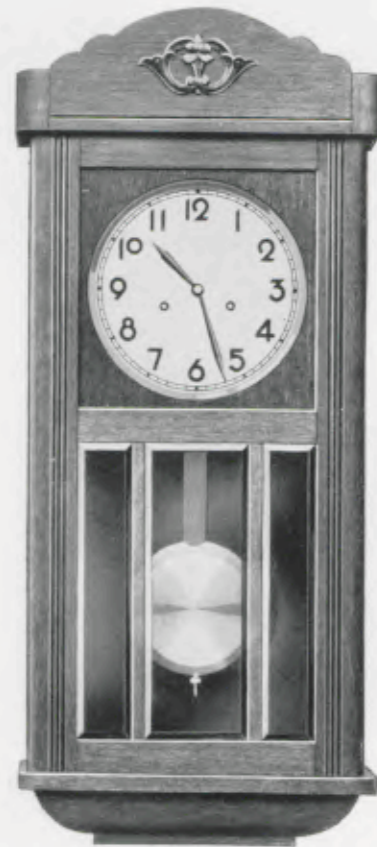

78 x 33 cm = 30 3/4 x 13 inches

1025/367

Nußbaum - Walnut - Noyer - Nogal

1025/368

Eiche - Oak - Chêne - Roble
Gewöhnliche Gläser - Plain glasses -
Verres simples - Vidrios ordinarios

1025/370

Eiche - Oak - Chêne - Roble
Facettegläser - Bevelled glasses -
Glaces biseautées - Cristales biselados

Waldgong - Bachgong - 1/4 Westminsterschlag

Waldgong - Gong „Bim Bam“ - 1/4 Westminster chime
Waldgong - Gong „Bim Bam“ - 1/4 Carillon Westminster
Sonería sobre Waldgong - Gong „Bim Bam“ - 1/4 Carillon Westminster

Eichengehäuse in allen Eichenfarben lieferbar - Oak cases can be had in all oak colours
Les cages chêne se livrent en toutes teintes de chêne - Se hacen las cajas en todos los colores de roble

Zifferblatt - Dial - Cadran - Esfera 20,5 cm = 8 inches



78 x 33 cm = 30 3/4 x 13 inches

1025/371

Nußbaum - Walnut - Noyer - Nogal

1025/372

Eiche - Oak - Chêne - Roble

1025/522

Mahagonifarbig - Mahogany finish -
Teinte acajou - Color caoba



GRUPPE 1025

Wanduhren

Wall clocks - Régulateurs - Reguladores



78 x 33 cm = 30 3/4 x 13 inches

1025/484

Eiche - Oak - Chêne - Roble

1025/485

Nußbaum - Walnut - Noyer - Nogal



78 x 33 cm = 30 3/4 x 13 inches

1025/486

Eiche - Oak - Chêne - Roble

Waldgong - Bachgong - 1/4 Westminsterschlag

Waldgong - Gong „Bim Bam“ - 1/4 Westminster chime
Waldgong - Gong „Bim Bam“ - 1/4 Carillon Westminster
Sonería sobre Waldgong - Gong „Bim Bam“ - 1/4 Carillon Westminster

Eichengehäuse in allen Eichenfarben lieferbar - Oak cases can be had in all oak colours
Les cages chêne se livrent en toutes teintes de chêne - Se hacen las cajas en todos los colores de roble

Zifferblatt - Dial - Cadran - Esfera 20,5 cm = 8 inches



78 x 33 cm = 30 3/4 x 13 inches

1025/487

Eiche - Oak - Chêne - Roble

1025/488

Nußbaum - Walnut - Noyer - Nogal



GRUPPE 1025

Wanduhren

Wall clocks - Régulateurs - Reguladores



79 x 34,5 cm = 31 1/4 x 13 1/2 inches

1025/440

Eiche - Oak - Chêne - Roble



79 x 34,5 cm = 31 1/4 x 13 1/2 inches

1025/442

Eiche - Oak - Chêne - Roble

Waldgong - Bachgong - 1/4 Westminsterschlag

Waldgong - Gong „Bim Bam“ - 1/4 Westminster chime

Waldgong - Gong „Bim Bam“ - 1/4 Carillon Westminster

Sonería sobre Waldgong - Gong „Bim Bam“ - 1/4 Carillon Westminster

In allen Eichenfarben lieferbar - Can be had in all oak colours

Livrables en toutes teintes de chêne - Se hacen las cajas en todos los colores de roble

Zifferblatt - Dial - Cadran - Esfera 21,5 cm = 8 1/2 inches



GRUPPE 1025

Wanduhren

Wall clocks - Régulateurs - Reguladores



78 x 34,5 cm = 30 3/4 x 13 1/2 inches

1025/558

Eiche - Oak - Chêne - Roble



78 x 34,5 cm = 30 3/4 x 13 1/2 inches

1025/557

Nußbaum poliert - Polished walnut
Noyer poli - Nogal pulido



78 x 34,5 cm = 30 3/4 x 13 1/2 inches

1025/562

Eiche - Oak - Chêne - Roble

Waldgong - Bachgong - 1/4 Westminsterschlag

Waldgong - Gong „Bim Bam“ - 1/4 Westminster chime

Waldgong - Gong „Bim Bam“ - 1/4 Carillon Westminster

Sonería sobre Waldgong - Gong „Bim Bam“ - 1/4 Carillon Westminster

Eichengehäuse in allen Eichenfarben lieferbar - Oak cases can be had in all oak colours

Les cages chêne se livrent en toutes teintes de chêne - Se hacen las cajas en todos los colores de roble

Zifferblatt - Dial - Cadran - Esfera 21,5 cm = 8 1/2 inches



GRUPPE 1025

Wanduhren

Wall clocks - Régulateurs - Reguladores



78 x 34,5 cm = 30 3/4 x 13 1/2 inches

1025/564

Eiche - Oak - Chêne - Roble

Metallblatt - Metal dial - Cadran métal - Esfera de metal
21,5 cm = 8 1/2 inches

Waldgong - Bachgong - 1/4 Westminsterschlag
Waldgong - Gong „Bim Bam“ - 1/4 Westminster chime
Waldgong - Gong „Bim Bam“ - 1/4 Carillon Westminster
Soneria sobre Waldgong - Gong „Bim Bam“ - 1/4 Carillon Westminster

Eichengehäuse in allen Eichenfarben lieferbar - Oak cases can be had in all oak colours
Les cages chêne se livrent en toutes teintes de chêne - Se hacen las cajas en todos los colores de roble



78 x 34,5 cm = 30 3/4 x 13 1/2 inches

1025/566

Eiche - Oak - Chêne - Roble



78 x 33 cm = 30 3/4 x 13 inches

1025/492

Eiche - Oak - Chêne - Roble

1025/493
Nußbaum - Walnut - Noyer - Nogal

Metallblatt - Metal dial -
Cadran métal - Esfera de metal
20,5 cm = 8 inches



GRUPPE 1025

Wanduhren

Wall clocks - Régulateurs - Reguladores



77 x 33 cm = 30 1/4 x 14 1/4 inches

1025/524

Eiche - Oak - Chêne - Roble



77 x 36 cm = 30 1/4 x 14 1/4 inches

1025/525

Eiche, Messing- oder Chrom-
verglasung

Oak, bevelled pendulum-glass in brass
or chromium plated fitting
Chêne, vitrage sert sur laiton ou chrome
Roble, vidriera de latón ó cromada

Zifferblatt - Dial - Cadran - Esfera 20,5 cm = 8 inches
Waldgong - Bachgong - 1/4 Westminsterschlag
Waldgong - Gong „Bim Bam“ - 1/4 Westminster chime
Waldgong - Gong „Bim Bam“ - 1/4 Carillon Westminster
Sonería sobre Waldgong - Gong „Bim Bam“ - 1/4 Carillon Westminster

In allen Eichenfarben lieferbar - Can be had in all oak colours
Livrables en toutes teintes de chêne - Se hacen las cajas en todos los colores de roble



77 x 36 cm = 30 1/4 x 14 1/4 inches

1025/527

Eiche, 20,5 cm imit. Silberzahlenreih

Oak, 8" imit. silvered figure-circle
Chêne, cercle à chiffres argenté imit.
20,5 cm
Roble, cerco de cifras plateado imit.
20,5 cm



GRUPPE 1025
Wanduhren
Wall clocks - Régulateurs - Reguladores

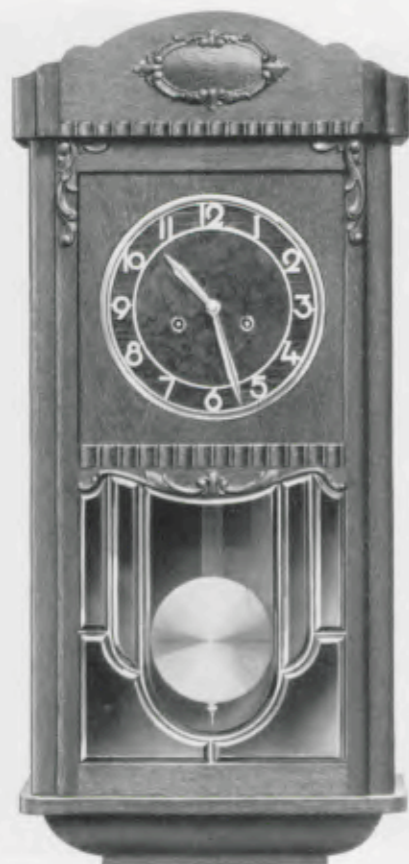

77 x 36 cm = 30 1/4 x 14 1/4 inches

1025/528

Eiche

Messing- oder Chromverglasung
20,5 cm imit. Silberzahlenreif

Oak

Bevelled pendulum-glass in brass or chromium plated fitting, 8" imit. silvered figure-circle

Chêne

Vitrage serti sur laiton ou chromé, cercle à chiffres argenté imit. 20,5 cm

Roble

Vidriera de latón ó cromadas, cerco de cifras plateado imit. 20,5 cm

Waldgong - Bachgong - 1/4 Westminsterschlag

Waldgong - Gong „Bim Bam“ - 1/4 Westminster chime

Waldgong - Gong „Bim Bam“ - 1/4 Carillon Westminster

Sonería sobre Waldgong - Gong „Bim Bam“ - 1/4 Carillon Westminster

In allen Eichenfarben lieferbar - Can be had in all oak colours

Livrables en toutes teintes de chêne - Se hacen las cajas en todos los colores de roble



77 x 36 cm = 30 1/4 x 14 1/4 inches

1025/529

Eiche

Facettegläser, 21,5 cm Metallblatt

Oak

Bevelled glasses, metal dial 8 1/2 inches

Chêne

Glaces biseautées, cadran métal 21,5 cm

Roble

Vidrios biselados, esfera de metal 21,5 cm



GRUPPE 1025
Wanduhren
Wall clocks - Régulateurs - Reguladores



77 x 36 cm = 30 1/4 x 14 1/4 inches

1025/530

Eiche, Messing- oder Chromverglasung

Oak, bevelled pendulum-glass in brass or chromium plated fitting

Chêne, vitrage serti sur laiton ou chrome

Roble, vidrieras de latón ó cromadas



77 x 36 cm = 30 1/4 x 14 1/4 inches

1025/362

Nußbaum - Walnut - Noyer - Nogal

1025/363

Eiche - Oak - Chêne - Roble

Messingverglasungen No. 102 und 149

Brass mounted bevelled glasses No. 102 and No. 149 - Glaces biseautées, serties sur laiton. No. 102 et 149 - Vidrieras de latón No. 102 y 149

Metallblatt - Metal dial - Cadran métal - Esfera de metal 21,5 cm = 8 1/2 inches

Waldgong - Bachgong - 1/4 Westminsterschlag

Waldgong - Gong „Bim Bam“ - 1/4 Westminster chime

Waldgong - Gong „Bim Bam“ - 1/4 Carillon Westminster

Sonería sobre Waldgong - Gong „Bim Bam“ - 1/4 Carillon Westminster

Eichengehäuse in allen Eichenfarben lieferbar - Oak cases can be had in all oak colours

Les cages chêne se livrent en toutes teintes de chêne - Se hacen las cajas en todos los colores de roble



78 x 35 cm = 30 1/4 x 13 3/4 inches

1025/568

Eiche - Oak - Chêne - Roble



GRUPPE 1025

Wanduhren

Wall clocks - Régulateurs - Reguladores



77 x 36 cm = 30 1/4 x 14 1/8 inches

1025/559

Nußbaum poliert - Polished
walnut - Noyer poli - Nogal
pulido

Metallblatt - Metal dial - Cadran métal - Esfera de metal
20,5 cm = 8 inches

Waldgong - Bechgong - 1/4 Westminsterschlag
Waldgong - Gong „Bim Bam“ - 1/4 Westminster chime
Waldgong - Gong „Bim Bam“ - 1/4 Carillon Westminster
Soneria sobre Waldgong - Gong „Bim Bam“ - 1/4 Carillon Westminster

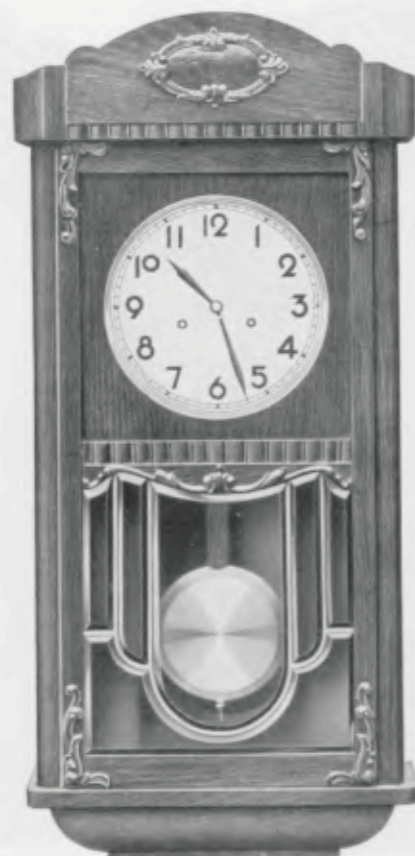

77 x 36 cm = 30 1/4 x 14 1/8 inches

1025/561

Nußbaum poliert - Polished
walnut - Noyer poli - Nogal
pulido

21,5 cm = 8 1/2 inches



GRUPPE 1027

Aparte Wanduhren für die moderne Wohnung

Smart wall clocks for the modern home - Pendules art nouveau pour intérieurs modernes
Relojes de pared especiales para la casa moderna

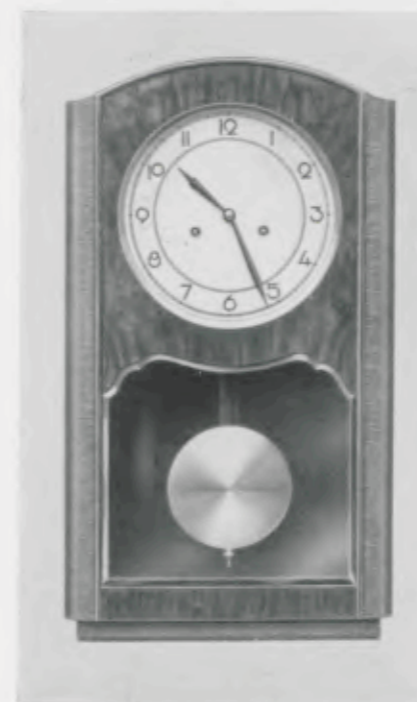

53 x 30 cm = 20 7/8 x 11 7/8 inches

1027/79

Eiche mit kaukasisch Nußbaum poliert
Facetteglas, 20,5 cm - 8" Metallblatt

Oak with polished Caucasian walnut
Bevelled glass, 8" metal dial

Chêne avec noyer Caucasiens poli
Glace biseautée, cadran métal 20,5 cm

Koble con nogal Cáucaso pulido
Vidrio biselado, esfera de metal, 20,5 cm

14 Tag Halbstund-Schlagwerk, Einstabgong oder Bim Bam 4 Stäbe

14 day 1/2 hour strike, rod gong or gong „Bim Bam“: 4 rods

15 jours sonnerie, heures et demies, gong tige ou gong „Bim Bam“: 4 tiges

15 días sonería, horas y medias, sonería sobre gong tije ó gong „Bim Bam“: 4 varillas

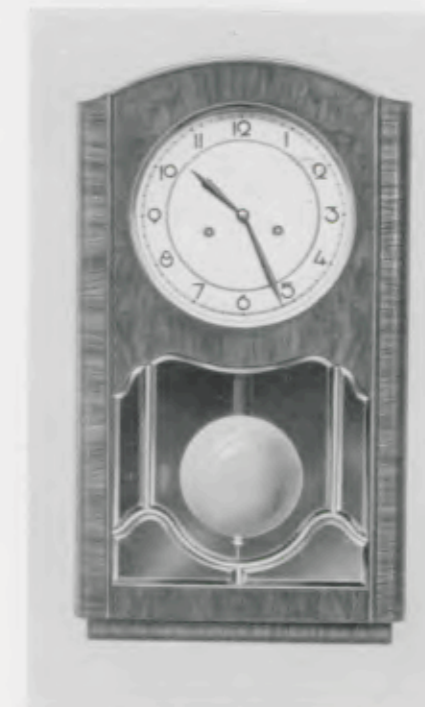

53 x 30 cm = 20 7/8 x 11 7/8 inches

1027/78

Kaukasisch Nußbaum poliert
Chromverglasung, 20,5 cm - 8" Metallblatt

Polished Caucasian walnut
Chromium plated fitting, 8" metal dial

Noyer Caucasiens poli
Panneau de glace chromé, cadran métal
20,5 cm

Nogal Cáucaso pulido
Vidriera cromado, esfera de metal, 20,5 cm



GRUPPE 1027

Aparte Wanduhren für die moderne Wohnung

Smart wall clocks for the modern home - Pendules art nouveau pour intérieurs modernes
Relojes de pared especiales para la casa moderna

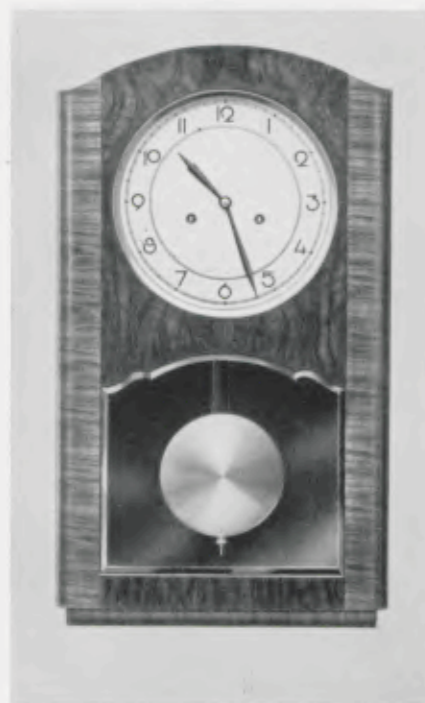

53 x 30 cm - 20 3/4 x 11 3/4 inches

1027/80

Kaukasisch Nußbaum poliert
Facetteglas, 20,5 cm - 8" Metallblatt

Polished Caucasian walnut
Bevelled glass, 8" metal dial

Noyer Caucasiens poli
Glace biseautée, cadran métal 20,5 cm
Nogal Caúcaso pulido
Vidrio biselado, esfera de metal 20,5 cm

14 Tag Halbstund-Schlagwerk, Einstabgong oder Bim Bam 4 Stäbe

14 day 1/2 hour strike, rod gong or gong „Bim Bam“: 4 rods

15 jours sonnerie, heures et demies, gong tige ou gong „Bim Bam“: 4 tiges

15 días sonería, horas y medias, sonería sobre gong tija ó gong „Bim Bam“: 4 varillas

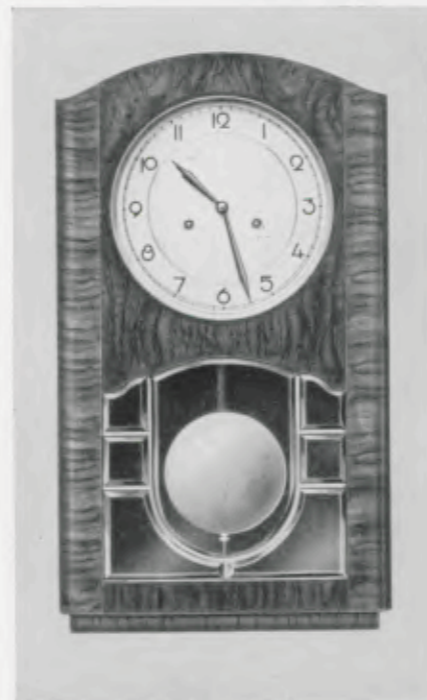

53 x 30 cm - 20 3/4 x 11 3/4 inches

1027/81

Kaukasisch Nußbaum poliert
Chromverglasung, 20,5 cm - 8" Metallblatt

Polished Caucasian walnut
Chromium plated fitting, 8" metal dial

Noyer Caucasiens poli
Panneau de glace chromé, cadran métal
20,5 cm
Nogal Caúcaso pulido
Vidriera cromada, esfera de metal 20,5 cm



GRUPPE 1027

Aparte Wanduhren für die moderne Wohnung

Smart wall clocks for the modern home - Pendules art nouveau pour intérieurs modernes
Relojes de pared especiales para la casa moderna



61,5 x 36 cm - 24 1/4 x 14 1/4 inches

1027/65

Kaukasisch Nußbaum poliert
Silberblatt, Chromverglasung

Polished Caucasian walnut
Silver dial, chromium fitting

Noyer Caucasiens poli
Cadran argenté, vitrage chromé
Nogal Caúcaso pulido
Esfera plateada, vitraux cromados

Waldgong - Bim Bam 5 Stäbe - 1/4, Westminster

Gong - Gong „Bim Bam“: 5 rods - 1/4, Westminster chime

Gong rond - Gong „Bim Bam“: 5 tiges - 1/4, Carillon Westminster

Gong redondo - Gong „Bim Bam“: 5 varillas - 1/4, Carillon Westminster



61,5 x 36 cm - 24 1/4 x 14 1/4 inches

1027/66

Kaukasisch Nußbaum poliert
Silberblatt, Chromauflagen,
Chromverglasung

Polished Caucasian walnut
Silver dial, chromium ornaments,
chromium fitting

Noyer Caucasiens poli
Cadran argenté, applications chromées,
vitrage chromé

Nogal Caúcaso pulido
Esfera plateada, aplicaciones cromadas,
vitraux cromados



GRUPPE 1027

Aparte Wanduhren für die moderne Wohnung

Smart wall clocks for the modern home - Pendules art nouveau pour intérieurs modernes
Relojes de pared especiales para la casa moderna

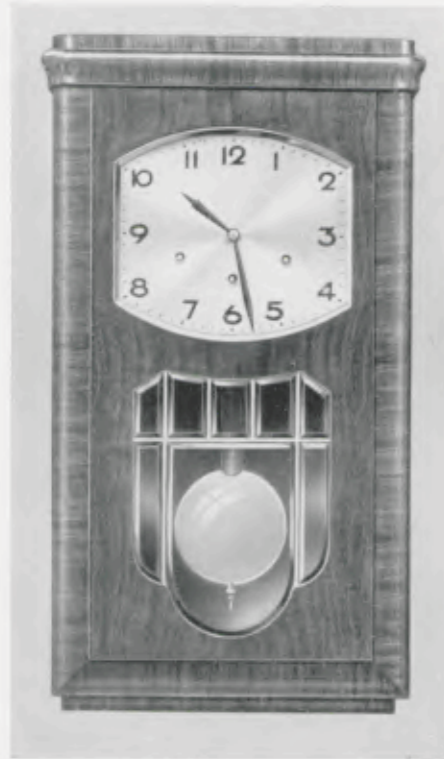

81,5 x 38 cm = 24 1/4 x 14 1/4 inches

1027/67

Kaukasisch Nußbaum poliert
Silberblatt, Chromverglasung

Polished Caucasian walnut
Silver dial, chromium fitting

Noyer Caucasiens poli
Cadran argenté, vitrage chromé

Nogal Caúcaso pulido
Esfera plateada, vitraux cromados

Waldgong - Bim Bam 5 Stäbe - 1/4 Westminster

Gong - Gong „Bim Bam“: 5 rods - 1/4 Westminster chime

Gong rond - Gong „Bim Bam“: 5 tiges - 1/4 Carillon Westminster

Gong redondo - Gong „Bim Bam“: 5 varillas - 1/4 Carillon Westminster

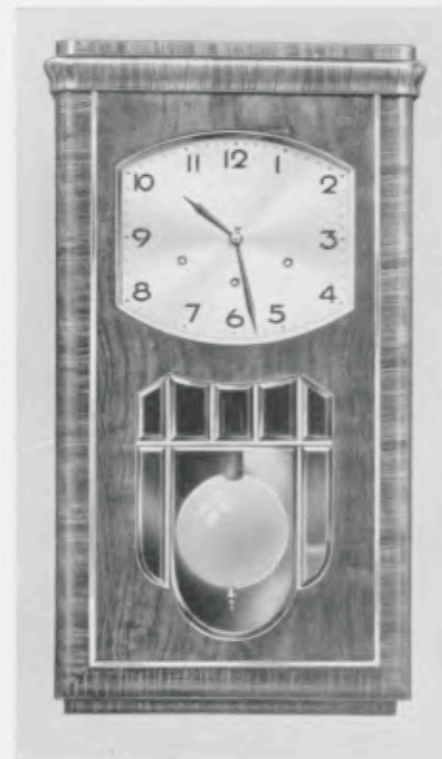

81,5 x 38 cm = 24 1/4 x 14 1/4 inches

1027/68

Kaukasisch Nußbaum poliert
Silberblatt, Chromauflagen,
Chromverglasung

Polished Caucasian walnut
Silver dial, chromium ornaments,
chromium fitting

Noyer Caucasiens poli
Cadran argenté, applications chromées,
vitrage chromé

Nogal Caúcaso pulido
Esfera plateada, aplicaciones cromadas,
vitraux cromados



GRUPPE 1028

Dielenuhren

Hall clocks - Horloges de parquet
Relojes de recibidor

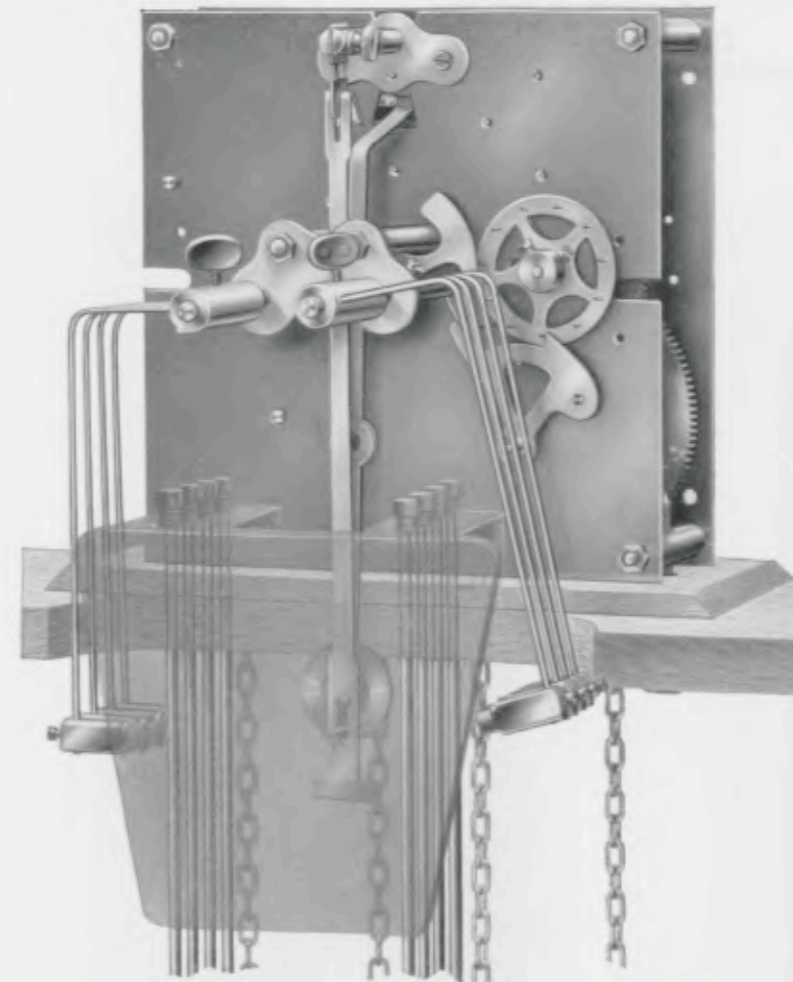

Platinen - Plates - Platinas - Platinas
15 x 15 cm = 6 x 6 inches

Werk - Movement - Mouvement
Máquina

No. 225

Schwinghamnergong, Bim Bam
8 Stäbe

Gravity Hammers Gong, Bim Bam 8 rods
Marteaux oscillateurs, Bim Bam 8 tiges
Martillos oscilantes, Bim Bam 8 varillas

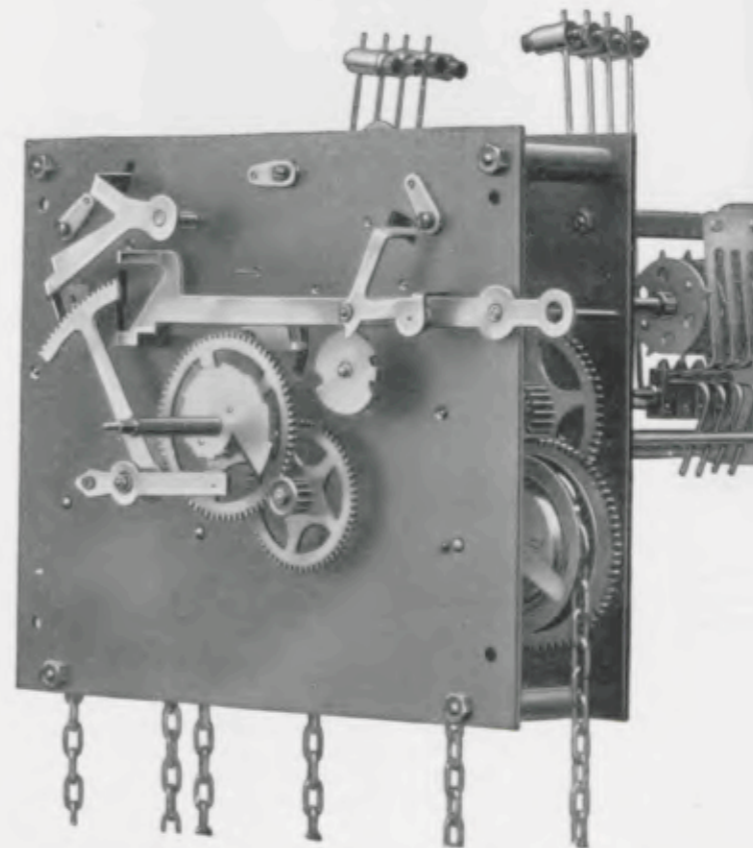

Platinen - Plates - Platinas - Platinas
155 x 125 mm = 6 1/4 x 7 1/4 inches

Werk - Movement - Mouvement - Máquina
No. 70

8 Tag 1/4 Westminster-Rechenschlagwerk,
Dreilauf, 8 Hämmer, massive Triebe, Graham-
anker

1/4 Westminster chime, 8 day rack strike, three
trains, 8 hammers, solid pinions, Graham
escapement

Mouvement pour Horloges de Parquet, 1/4 West-
minster, 8 dias sonerie à réseau, trois trains,
8 marteaux, pignons massifs, échappement
Graham

Máquina para Relojes de vestibulo, 1/4 West-
minster, 8 dias sonerie à sierra, tres pases,
8 martillos, piñones masivos, áncora sistema
Graham



GRUPPE 1028

Dielenuhren

Hall clocks - Horloges de parquet - Relojes de recibidor

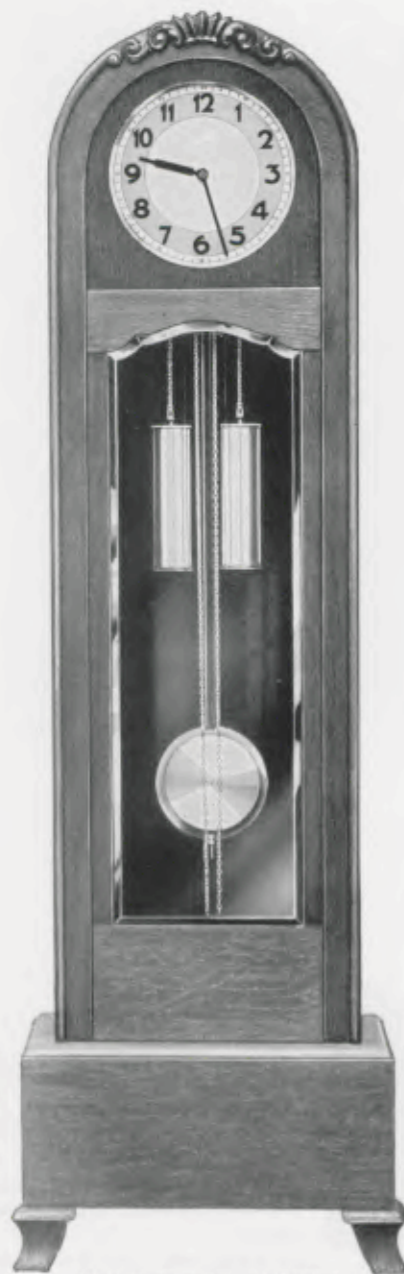

195 x 58 cm = 76 1/2 x 23 inches

1028/184

Eiche mit 30 cm Silberblatt, gedruckte Zahlen mit matt Silberreif, schwarze Zeiger, Gewichte matt Silber mit Chromdeckel, Pendellinse matt Silber mit Chromrand

Oak with 12 inches silver dial, weights and pendulum mat silvered
Chêne avec cadran argenté, 30 cm, poids et balancier argenté mat
Roble con esfera plateada, 30 cm, pesas y lenteja plateada mate



195 x 60 cm = 76 1/2 x 23 1/4 inches

1028/185

Eiche mit Nußbaum, 30 cm Silberblatt mit gedruckten Zahlen mit matt Silberreif, schwarze Zeiger, Gewichte matt Silber mit Chromdeckel, Pendellinse matt Silber mit Chromrand

Oak with walnut, 12 inches silver dial, weights and pendulum mat silvered
Chêne avec noyer, cadran argenté, 30 cm, poids et balancier argenté mat
Roble con nogal, esfera plateada, 30 cm, pesas y lenteja plateada mate



GRUPPE 1028

Dielenuhren

Hall clocks - Horloges de parquet - Relojes de recibidor

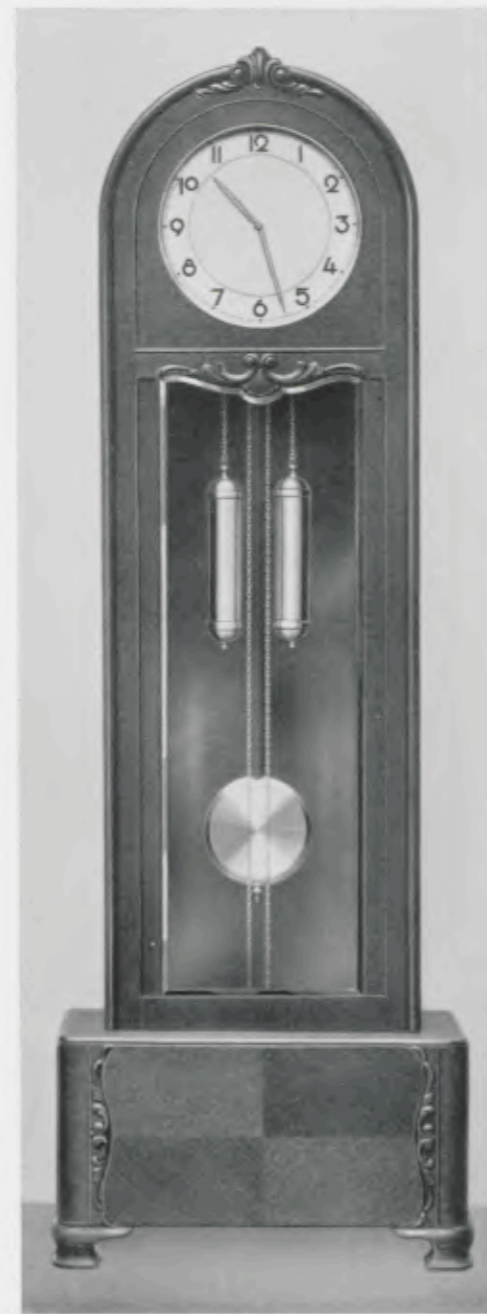

191 x 66 cm = 75 x 26 inches

1028/201

Eiche
33 cm - 13" Goldblatt
Oak
13" gilt dial
Chêne
Cadran doré, 33 cm
Roble
Esfera dorada, 33 cm

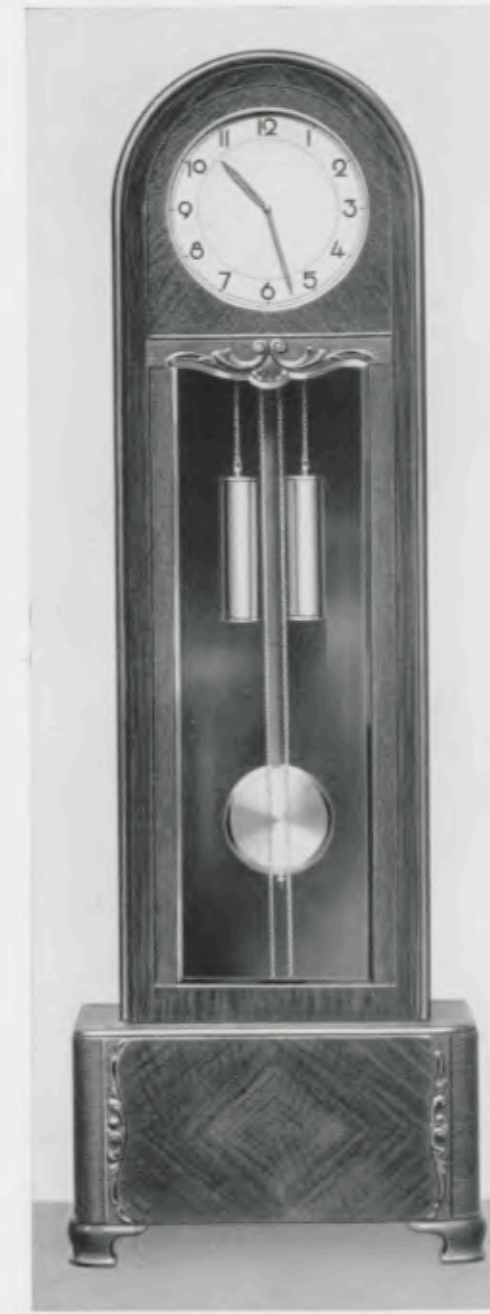

191 x 66 cm = 75 x 26 inches

1028/202

Eiche mit Nußbaum poliert
33 cm - 13" Goldblatt
Oak with polished walnut
13" gilt dial
Chêne avec noyer poli
Cadran doré, 33 cm
Roble con nogal pulido
Esfera dorada, 33 cm



GRUPPE 1028

Dielenuhren

Hall clocks - Horloges de parquet - Relojes de recibidor

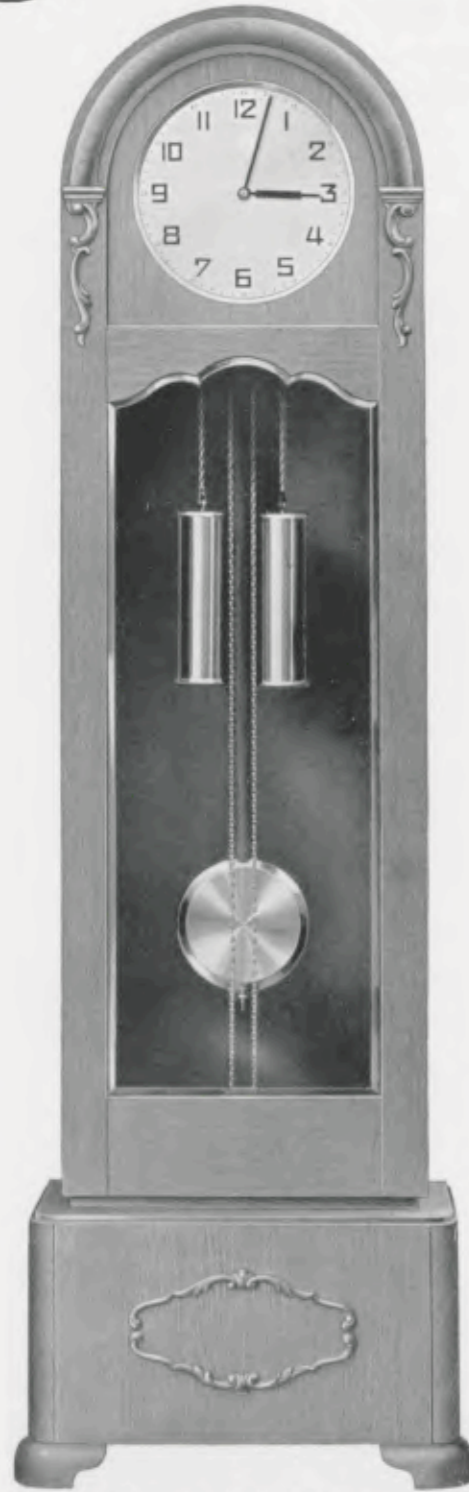

195 x 60 cm - 76 3/4 x 23 1/2 inches

1028/186

Facetteglas - Bevelled glass
Glace à biseau - Vidrio biselado

1028/187

Messingverglasung - Brass mounted glasses
Glace serties en cuivre
Cristales con engastes de latón

Eiche - Oak - Chêne - Roble
Zifferblatt - Dial - Cadran - Esfera
30 cm - 12"

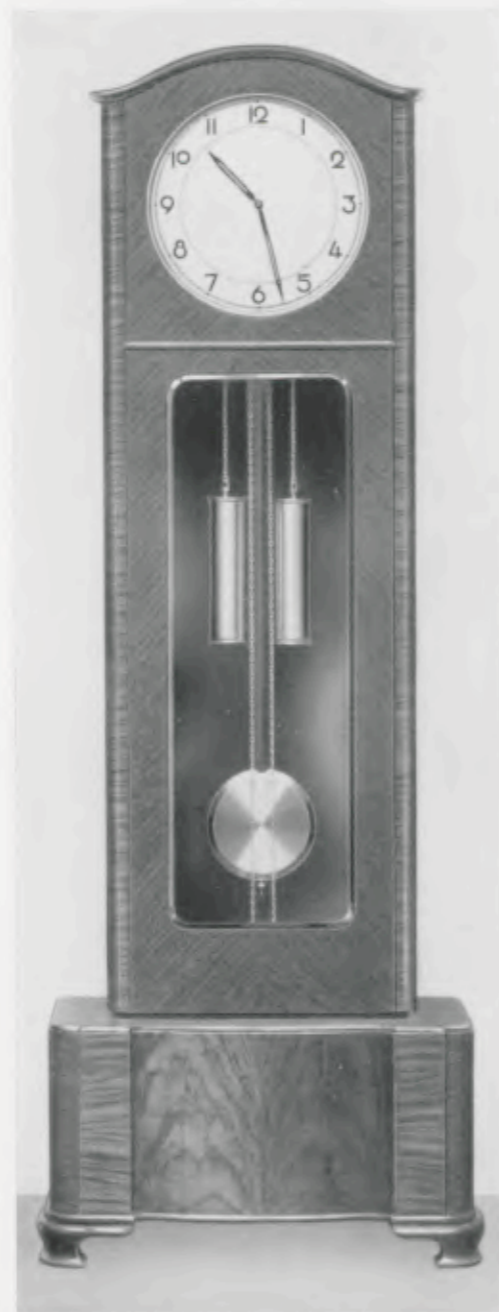

192 x 69 cm - 75 1/2 x 27 1/4 inches

1028/205

Eiche mit Nußbaum poliert, 36 cm - 14 1/4" Goldblatt
Oak with polished walnut, 14 1/4" gilt dial
Chêne avec noyer poli, cadran doré, 36 cm
Roble con nogal pulido, esfera dorada, 36 cm



GRUPPE 1028

Dielenuhren

Hall clocks - Horloges de parquet - Relojes de recibidor

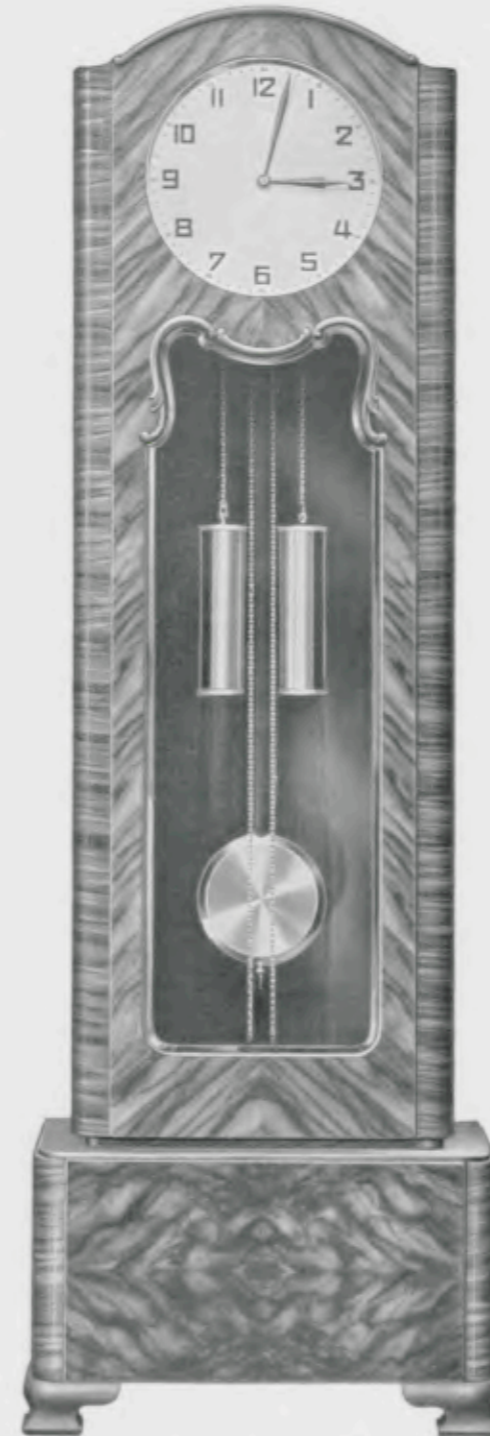

180 x 64 cm - 75 x 25 inches

1028/192

Geflammt Nußbaum poliert
33 cm Zifferblatt, Facetteglas

Polished figured walnut
13" dial, bevelled glass

Noyer ramageux poli
Cadran 33 cm, verre biseauté

Nogal yesado pulido
Esfera 33 cm, vidrio biselado

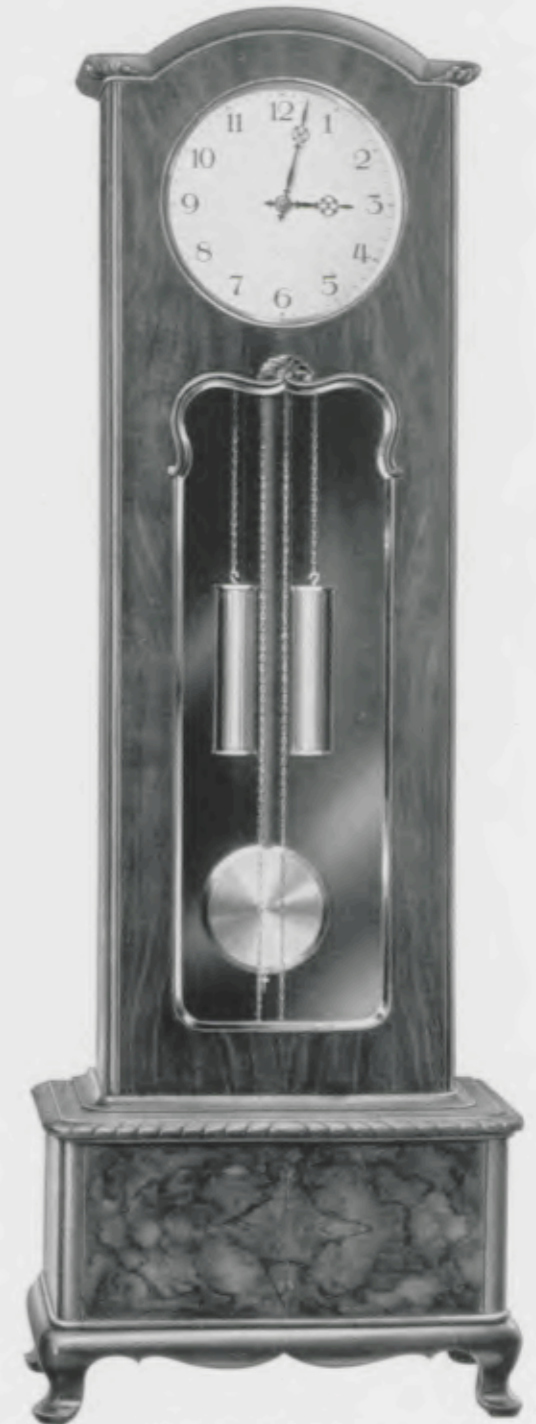

186 x 64 cm - 73 x 25 inches

1028/193

Nußbaum antik, Sockelfront poliert, 33 cm Zifferblatt, Facetteglas

Dull antique walnut polished base, 13" dial, bevelled glass

Noyer mat antique, socle poli, cadran, 33 cm, verre biseauté

Nogal mate antiguo, zócalo pulido, esfera 33 cm, vidrio biselado



