

# Jungheims



HAUPTKATALOG 1933  
MAIN-CATALOGUE • CATALOGUE PRINCIPAL • CATÁLOGO PRINCIPAL



**UHRENFABRIKEN**

Watch- and Clock Factories — Fabriques d'horlogerie — Fábricas de relojes

*Gebrüder Junghans*

**A.-G.**

**SCHRAMBERG**

Schwarzwald — Black-Forest — Forêt-Noire — Selva negra



**Musterschutz**

Unsere Muster sind in das Musterschutzregister für plastische Erzeugnisse eingetragen, also gesetzlich geschützt. Nachahmungen werden gerichtlich verfolgt.

Our patterns are registered and therefore legally protected. Imitations will be prosecuted. — Nos modèles sont inscrits dans le registre de brevets sur produits plastiques et se trouvent, par conséquent, sous protection de la loi. Les imitations sont poursuivies. — Modelos depositados, protegidos por la ley.



## Gruppen-Verzeichnis

Index of Groups \* Index des groupes \* Indice por grupos

Gruppe		Page	Gruppe		Page
4	<b>Kleinste Qualitäts-Wecker</b> Smallest highclass quality alarms Réveils miniature de qualité supérieure Despertadores miniatura de calidad superior	5	18	<b>Bürouhren - Rundrahmenuhren</b> Dial clocks - Office clocks Eils de Bœuf - Pendules pour bureaux Relojes de pared y para despachos	62
5	<b>Boudoir-Uhren</b> Boudoir clocks Pendulettes de boudoir Relojes para tocador	9	19	<b>Küchenuhren</b> Kitchen clocks Pendules pour cuisine Relojes de cocina	78
6					
7	<b>Miniatur-Wecker</b> Miniature alarms Réveils miniature Despertadores de miniatura	24	21	<b>Regulateure</b> Regulators Régulateurs Reguladores	84
8	<b>Wecker in Metall- und Holzgehäusen</b> Alarm clocks in metal and wooden cases Réveils en boîtes métal et bois Despertadores en cajas de metal y de madera	25	23	<b>Wanduhren</b> Regulators Régulateurs Reguladores	86
9		39			
	10	40	28	<b>Dielenuhren</b> Hall clocks Horloges de parquet Relojes de recibidor	102
12	<b>Schiffuhren . Autouhren</b> Ship clocks . Motor Car clocks Horloges marines . Montres pour autos Relojes marina . Relojes para Automovil	42	54	<b>Miniatur-Wecker</b> Miniature alarms Réveils miniature Despertadores miniatura	21
14		43			
17	<b>Kaminuhren</b> Mantle clocks Pendules de cheminée Relojes de sobremesa	44	101	<b>Reisenuhren</b> Travelling watches Montres de voyage Relojes para viaje	1



## Nummern-Verzeichnis

Index of numbers \* Index des numéros \* Indice por números

N <sup>o</sup>	Seite Page	N <sup>o</sup>	Seite Page	N <sup>o</sup>	Seite Page
4/17-18 RZ	5	8/2	27	12/1-62	42
4/48-49	8	8/9-40	38	14/23	43
4/51	8	8/98-100	26	14/121-122	43
4/106	8	8/184	28	17/459	50
4/291-292 RZ	5	8/188	30	17/528	49
4/294 RZ	5	8/190	28	17/540-541	45
4/301-304 RZ	5	8/191	26	17/542	46
4/320-322 RZ	6	8/197-202	30	17/544-546	47
4/323 RZ	5	8/204	30	17/547	48
4/324-327 RZ	7	8/206-208	31	17/548	49
4/329 RZ	5	8/209-211	28	17/549	50
4/330	6	8/213-219	29	17/554	54
		8/220-222	30	17/569	48
		8/223-227	32	17/575	59
5/190	11	8/228	27	17/577	56
5/193	11	8/233	30	17/596	59
5/197	11	8/234-236	26	17/597	60
5/199-200	11	8/242	27	17/598	60
5/209	17	8/246-247	26	17/611-614	51
5/215-218	10	8/266-267	28	17/615	52
5/219-220	14	8/270-273	31	17/631	54
5/223-224	14	8/276-278	28	17/632	53
5/225-226	15	8/284-285	29	17/633	54
5/227-228	16	8/293-295	29	17/634	56
5/229-230	12	8/301-302	36	17/635	52
5/237	17	8/307-308	29	17/636	53
5/238-239	9	8/309	28	17/637	60
5/240-241	12	8/316-319	33	17/638-639	57
5/242-243	13	8/321-322	33	17/640	54
		8/331-332	34	17/641	57
		8/338-339	34	17/642	58
6/3-6	20	8/340-343	33	17/643	53
6/16	20	8/344-347	34	17/644	52
6/17-20	18	8/348-353	35	17/646	49
6/21-22	19			17/647	45
6/27-28	18	9/133-134	39	17/648	46
6/29-32	19			17/649	49
		10/62	40	17/650-651	56
7/195-196	24	10/66-68	40		
7/323-324	24	10/69-71	41		



## Nummern-Verzeichnis

Index of numbers \* Index des numéros \* Índice por números

N <sup>o</sup>	Seite Page	N <sup>o</sup>	Seite Page	N <sup>o</sup>	Seite Page
<b>17</b> /652-654 .....	55	<b>19</b> /365-366 .....	78	<b>54</b> /1 .....	21
17/655 .....	58	19/367-369 .....	79	54/3 .....	21
17/656 .....	55	19/370-371 .....	80	54/11-13 .....	21
17/657 .....	59	19/372-373 .....	81	54/101-102 .....	22
17/658 .....	58			54/104-105 .....	22
Konsole No. 1 .....	61	<b>20</b> /4-5 .....	82	54/107 .....	22
		20/6-9 .....	83	54/119 .....	22
<b>18</b> /1-3 .....	63			54/121-124 .....	22
18/42 .....	77	<b>21</b> /12 .....	84	54/161 .....	21
18/71 .....	76	21/32 .....	84	54/244 .....	23
18/91-94 .....	66	21/53 .....	85	54/246-251 .....	23
18/96 .....	76				
18/100-103 .....	66	<b>23</b> /79 .....	87	<b>56</b> /25-27 .....	37
18/133-144 .....	67	23/81, 83 .....	87	56/41 .....	37
18/169-170 .....	66	23/86-87 .....	87		
18/173-176 .....	66	23/88-93 .....	88	<b>101</b> /37 RZ .....	3
18/181-182 .....	63			101/40 RZ .....	3
18/202-213 .....	64	<b>24</b> /80 .....	92	101/41 RZ .....	3
18/216-236 .....	65	24/111-116 .....	90	101/61 RZ .....	4
18/248 .....	73	24/119 .....	89	101/63 RZ .....	4
18/250-252 .....	72	24/120-125 .....	91	101/65 RZ .....	4
18/253-254 .....	73	24/126-127 .....	89	101/67 RZ .....	4
18/255-258 .....	75			101/102 RZ .....	1
18/259-261 .....	68	<b>25</b> /316-317 .....	99	101/106 RZ .....	1
18/263-267 .....	74	25/367-372 .....	95	101/110-111 RZ .....	2
18/268-270 .....	71	25/466-471 .....	94	101/113-114 RZ .....	1
18/271-272 .....	68	25/484-488 .....	96	101/115-116 RZ .....	2
18/275 .....	70	25/489-493 .....	97		
18/276-280 .....	69	25/494-495 .....	98		
18/281-283 .....	70				
<b>19</b> /318-319 .....	79	<b>27</b> /16-18 .....	100		
19/340 .....	80	27/20-26 .....	101		
19/342-347 .....	78	27/27-29 .....	100		
19/348-349 .....	79				
19/350-351 .....	81	<b>28</b> /155-156 .....	103		
19/352-355 .....	78	28/158-159 .....	104		
19/357-359 .....	80	28/161 .....	105		
19/360 .....	81	28/166 .....	105		
19/361-363 .....	80				



## Namen-Verzeichnis

Index of names \* Index des noms \* Índice por nombres

	Seite Page		Seite Page		Seite Page
<b>A</b> frika .....	66	<b>J</b> azzo .....	37	Neu-Darling .....	5
Agnes .....	64	Joker I .....	38	Neu-Triumph .....	24
Altai .....	65	„ II .....	38	Neu-Villach .....	87
Azur .....	22	„ III .....	38	Norden .....	87
		Isar .....	85		
<b>B</b> aby .....	26			<b>O</b> ffice .....	77
Boxer .....	29	<b>K</b> alender .....	21	Oldenburg I .....	98
Bravetto .....	28	Kassel I .....	94	„ II .....	98
Bravo .....	30	„ II .....	94		
„ a. Sockel .....	30	„ IV .....	94	<b>P</b> ionier I .....	31
„ J .....	30	Kiel I .....	95	„ II .....	31
Buenos Aires .....	67	„ II .....	95	Primus I .....	21
		„ IV .....	95	„ II .....	21
<b>C</b> alcutta .....	76				
Colombo .....	87	<b>L</b> auenburg I .....	97	<b>R</b> angoon .....	76
		„ II .....	97	Regent I .....	29
<b>D</b> arling .....	5	„ IV .....	97	„ II .....	29
Desk I u. II .....	21	Lloyd II .....	32		
		Lüneburg I .....	96	<b>S</b> ilent .....	35
<b>E</b> lefant .....	8	„ II .....	96	Sulu .....	37
Elegant .....	8	„ IV .....	96	Start .....	22
				Stella .....	26
<b>F</b> lotte .....	42	<b>M</b> arburg I .....	99		
Fußball .....	37	„ II .....	99	<b>T</b> ommy .....	27
		Marine .....	42	Turner .....	30
<b>G</b> amin .....	8	Meiringen .....	92		
Globe .....	26	Mosel III .....	84	<b>Ü</b> berlingen I .....	91
Gloria .....	22			„ II .....	91
Gossau I .....	90	<b>N</b> eu-Alemannia .....	5	„ IV .....	91
„ II .....	90	Neu-Bravetto .....	28		
„ IV .....	90	Neu-Bravo .....	31	<b>W</b> eser .....	84
		Neu-Bruck I .....	88	World I .....	42
<b>H</b> alli I .....	32	„ II .....	88	„ II .....	66
„ II .....	32	„ III .....	88		



GRUPPE 101

Reiseuhren

Travelling watches — Montres de voyage — Relojes para viaje



Durchmesser — Diameter — Diamètre  
Diámetro 6,8 cm — 2 3/4 inches

Kalotte Werk J 66 (ohne Etui) für Etui-Ausschnitt 63 1/2 mm

Calotte movement J 66 (without leather case) for case-opening 63 1/2 mm

Calotte mouvement J 66 (sans écriin) pour ouverture d'écriin de 63 1/2 mm

Máquina completa J 66 (sin estuche) para abertura de estuche de 63 1/2 mm



10 x 10 cm — 4 x 4 inches

**101/102 RZ** Saffian-Schaffleder, rotbraun — Brown sheep's skin, morocco grained — Mouton grain maroquin, brun-rouge — Badana tafilete, moreno

**101/113 RZ** Saffian-Schaffleder, dunkelbraun — Brown sheep's skin, morocco grained — Mouton grain maroquin, brun — Badana tafilete, moreno



10 x 10 cm — 4 x 4 inches

**101/106 RZ** Krokodilimitation, dunkelbraun — Brown crocodile, grained — Crocodile grain, brun — Piel de cocodrilo imitación, moreno



10 x 10 cm — 4 x 4 inches

**101/114 RZ** Echt Saffian, grau — Morocco grey — Maroquin gris — Cabra gris

1 Tag Weckerwerk No. J 66 — 1 day alarm movement No. J 66  
30 heures réveil mouvement No. J 66 — 30 horas despertador máquina No. J 66

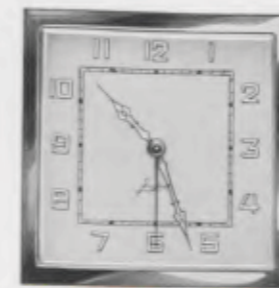

7,7 x 7,7 cm — 3 x 3 inches

Kalotte viereckig, Werk J 66 (ohne Etui) für Etui-Ausschnitt 61 x 61 mm

Square calotte, movement J 66 (without leather case) for case-opening 61 x 61 mm

Calotte carrée, mouvement J 66 (sans écriin) pour ouverture d'écriin de 61 x 61 mm

Máquina completa J 66 (sin estuche) para abertura de estuche de 61 x 61 mm



10 x 10 cm — 4 x 4 inches

**101/110 RZ** Saffian-Schaffleder, braun  
Brown sheep's skin, morocco grained  
Mouton grain maroquin, brun  
Badana tafilete, moreno



10 x 10 cm — 4 x 4 inches

**101/111 RZ** Saffian-Schaffleder, braun  
Brown sheep's skin, morocco grained  
Mouton grain maroquin, brun  
Badana tafilete, moreno



10 x 10 cm — 4 x 4 inches

**101/115 RZ** Tapir — Tapir — Tapiro



10 x 10 cm — 4 x 4 inches

**101/116 RZ** Eidechse — Lizard-skin  
Lézard — Lagarto

Viereck-Silberblatt, verchromter Rahmen — Square silver dial, chromium plated bezel  
Cadran carré argenté, lunette chromée — Esfera cuadrada plateada, bisel cromado

1 Tag Weckerwerk No. J 66 — 1 day alarm movement No. J 66  
30 heures réveil mouvement No. J 66 — 30 horas despertador máquina No. J 66



Durchmesser - Diameter - Diamètre  
Diámetro 5,5 cm - 2 1/8 inches

Kleine Kalotte, Werk J 36 mit 7 Steinen für Etui-Ausschnitt 53 mm  
 Große Kalotte, Werk J 36 mit 7 Steinen für Etui-Ausschnitt 63 1/2 mm  
 Small calotte, movement J 36 with 7 jewels for case-opening 53 mm  
 Large calotte, movement J 36 with 7 jewels for case-opening 63 1/2 mm  
 Petite calotte, mouvement J 36 à 7 rubis pour ouverture d'écrin de 53 mm  
 Grande calotte, mouvement J 36 à 7 rubis pour ouverture d'écrin de 63 1/2 mm  
 Máquina completa pequeña J 36 à 7 rubis para abertura de estuche de 53 mm  
 Máquina completa grande J 36 à 7 rubis para abertura de estuche de 63 1/2 mm



9 x 9 cm - 3 1/4 x 3 1/4 inches

101/37 RZ

Schwarz Saffian - Black morocco  
 Maroquin noir - Cabra negra



9 x 9 cm - 3 1/4 x 3 1/4 inches

101/40 RZ

Echt Saffian, cochenillerot - Cochineal morocco  
 Maroquin cochenille - Cabra cochenilla



9 x 9 cm - 3 1/4 x 3 1/4 inches

101/41 RZ

Braun Carara matt - Brown carara mat  
 Carara brun mat - Carara mate, moreno

1 Tag Weckerwerk No. J 36 mit 7 Steinen - 1 day alarm movement No. J 36 with 7 jewels  
 30 heures réveil mouvement No. J 36 avec 7 rubis - Despertador, 30 horas cuerda, máquina  
 No. J 36 con 7 rubis



9 x 9 cm - 3 1/4 x 3 1/4 inches

101/61 RZ

Schattenrindleder hellbraun - Cowhide brown  
 Cuir de bœuf brun avec ombres  
 Cuero de buey moreno con sombras



9 x 9 cm - 3 1/4 x 3 1/4 inches

101/63 RZ

Saffian, rotbraun - Morocco brown  
 Maroquin brun - Cabra moreno



11 x 9 cm - 4 1/4 x 3 1/4 inches

101/65 RZ

Echt Saffian, blau - Morocco blue  
 Maroquin bleu - Cabra azul



8 x 10 cm - 3 1/4 x 4 inches

101/67 RZ

Saffian-Schaffleder, braun - Brown sheep's skin, morocco grained - Mouton grain  
 maroquin, brun - Badana tablete, moreno

1 Tag Weckerwerk No. J 36 mit 7 Steinen - 1 day alarm movement No. J 36 with 7 jewels - 30 heures réveil mouvement No. J 36 avec 7 rubis - Despertador, 30 horas cuerda, máquina No. J 36 con 7 rubis



GRUPPE 4

Kleinste Qualitäts-Wecker - Ankerwerke mit Taschenuhrhemmung

Smallest highclass quality alarms - Lever-movement with watch escapement

Réveils miniature de qualité supérieure - Mouvement à ancre avec échappement de montre de poche

Despertadores miniatura de calidad superior - Máquina á áncora con escape de reloj de bolsillo

Neu-Alemannia



6 cm = 2 1/4 inches

4/291 RZ Rotbraun - Claret coloured - Brun-rouge  
Rojo oscuro

4/292 RZ Blau - Blue - Bleu - Azul

4/295 RZ Verchromt, Silberblatt - Chromium plated, silver dial - Chromé, cadran argenté  
Cromado, esfera plateada

Bügel-Absteller - The alarm is stopped by pushing the handle down  
Arrêtage du réveil par la poignée - El despertador se para doblando la manija

Neu-Alemannia



6 cm = 2 1/4 inches

4/301 RZ Rotbraun - Claret coloured - Brun-rouge  
Rojo oscuro

4/302 RZ Blau - Blue - Bleu - Azul

4/303 RZ Verchromt, Silberblatt - Chromium plated, silver dial - Chromé, cadran argenté  
Cromado, esfera plateada

Neu-Alemannia



6 cm = 2 1/4 inches

4/304 RZ Verchromt, Silberblatt - Chromium plated, silver dial - Chromé, cadran argenté  
Cromado, esfera plateada

Bügel-Absteller - The alarm is stopped by pushing the handle down  
Arrêtage du réveil par la poignée - El despertador se para doblando la manija

Darling



10 cm = 4 inches

4/17 RZ Versilbert - Silvered - Argenté - Plateado

4/18 RZ Vergoldet - Gilt - Doré - Dorado

1 Tag Weckerwerk No. J 63 - 1 day alarm movement No. J 63

30 heures réveil mouvement No. J 63 - 30 horas despertador máquina No. J 63

Neu-Darling



8 x 7,5 cm = 3 1/4 x 3 inches

4/329 RZ

Verchromt, Silberblatt - Chromium plated, silver dial - Chromé, cadran argenté - Cromado, esfera plateada

1 Tag Weckerwerk No. 79 - 1 day alarm movement  
No. 79 - 30 heures réveil mouvement No. 79 - 30 horas despertador, máquina No. 79

1 Tag Weckerwerk No. J 66 - 1 day alarm movement  
No. J 66 - 30 heures réveil mouvement No. J 66  
30 horas despertador, máquina No. J 66

Silber-, Gold- und Kartonblatt mit Radium-Ausstattung (RZ) - Silvered, gilt and cardboard dial with luminous figures (RZ)  
Cadran argenté, doré et cadran carton avec chiffres lumineux Radium (RZ)  
Esfera plateada, dorada y esfera de cartón con cifras luminosas Radium (RZ)



7 x 11 cm = 2 1/4 x 4 1/4 inches

4/323 Z RZ Zahlen - Figures - Chiffres - Cifras

4/323 S RZ Striche - Strokes - Barres - Rayas



1 Tag Weckerwerk No. J 66 - 1 day alarm movement No. J 66

30 heures réveil mouvement No. J 66 - 30 horas despertador, máquina No. J 66



7 cm = 2 3/4 inches

4/320 Z RZ Zahlen - Figures - Chiffres - Cifras

4/320 S RZ Striche - Strokes - Barres - Rayas



7 cm = 2 3/4 inches

4/322 Z RZ Zahlen - Figures - Chiffres - Cifras

4/322 S RZ Striche - Strokes - Barres - Rayas

Silberblatt - Silver dial - Cadran argenté - Esfera plateada



7 cm = 2 3/4 inches

4/321 Z RZ Zahlen - Figures - Chiffres - Cifras

4/321 S RZ Striche - Strokes - Barres - Rayas

Silberblatt - Silver dial - Cadran argenté - Esfera plateada



7 cm = 2 3/4 inches

4/330 Etui braun Carara-Imitation  
Brown carara imitation case



7,5 cm = 3 inches

4/330 Ecrin brun, imitation carara  
Estuche de carara imitación moreno



1 Tag Weckerwerk No. J 63 - 1 day alarm movement No. J 63  
30 heures réveil mouvement No. J 63 - 30 horas despertador, máquina No. J 63



8 x 15 cm = 3 1/8 x 6 inches

4/324 RZ

Kaukasisch Nußbaum poliert, Chromfüße  
Polished Caucasian walnut, chromium plated feet  
Noyer Caucasiens poli, pieds chromés  
Nogal Caúcaso pulido, pies cromados



7 x 12 cm = 2 7/8 x 4 3/4 inches

4/325 RZ

Kaukasisch Nußbaum mit Nußbaummaser poliert, Chromfüße  
Polished Caucasian walnut with bur walnut, chromium plated feet  
Noyer Caucasiens avec loupe de noyer poli, pieds chromés  
Nogal Caúcaso con raiz de nogal pulido, pies cromados



8 x 13 cm = 3 1/8 x 5 1/8 inches

4/326 RZ

Schleiflack schwarz, Kugeln und Füße verchromt  
Varnished black dull, balls and feet chromium plated  
Peinture noire laquée dépolie, boules et pieds chromés  
Barniz pulido mate, bolas y pies cromados



9 x 13 cm = 3 1/2 x 5 1/8 inches

4/327 RZ

Schleiflack schwarz, Träger und Kugeln verchromt  
Varnished black dull with chromium plated ornaments  
Peinture noire laquée dépolie, support et boules chromés  
Barniz pulido mate, portador y bolas cromados

Chromlünette, Silberblatt - Chromium plated bezel, silver dial  
Lunette chromée, cadran argenté - Bisel cromado, esfera plateada



## Schwingende Uhren, geschützte Junghans-Spezialität

8 Tag Gehwerk auf Steinen laufend

Elegant



35,5 cm = 14 inches

4/48 4/49

8 day Mystery Clocks, „Junghans“ speciality  
swinging pendulum suspended on jewelled bar  
Pendulettes Oscillantes dites Mystérieuses, spécialité brevetée-Junghans  
Marche 8 jours sur bras empierré  
Relojes oscilantes, 8 días cuerda, sobre rubis  
Modelos especiales registrados por la fábrica Junghans

Kunstgußfiguren

Bronze figures - Sujets artistiques en imitation bronze  
Figuras de fundición artística

Elefant



29 cm = 11 1/2 inches

4/51

4/48 Patiniert, polierter Holzsockel - Patina, polished wooden base - Patiné, socle en bois poli - Imitación bronce viejo, zócalo de madera pulida  
4/49 Vergoldet, polierter Holzsockel - Gilt, polished wooden base - Doré, socle en bois poli - Dorado, zócalo de madera pulida  
4/51 Patiniert, polierter Holzsockel - Patina, polished wooden base - Patiné, socle en bois poli - Imitación bronce viejo, zócalo de madera pulida  
4/106 Patiniert - Patina - Patiné - Imitación bronce viejo

Vorzügliche Regulierung / Absolute Unempfindlichkeit im Gebrauch, weil ohne Pendelfeder - Excellent time keeper  
The clock, having no pendulum spring, is absolutely insensible in handling - Réglage excellent / Insensibilité absolue dans l'emploi, parce que sans lame de suspension / Afinación exacta y por falta del muelle de suspensión inalterable en el uso

Gamin



45 cm = 17 3/4 inches

4/106





GRUPPE 5

Feine Boudoir-Uhren mit Qualitätswerk

Highclass quality boudoir clocks - Pendulettes de boudoir, qualité supérieure  
Relojes para tocador de calidad superior



Platinen - Plates - Platines - Platinas 52,5 mm = 2 1/4 inches

No. J 66

1 Tag flaches Weckerwerk, abnehmbare Anker- und Balancebrücke, herausnehmbare Federhäuser  
1 day alarm, removable balance and lever bridges, interchangeable spring barrel  
Mouvement, 30 heures réveil, pont d'ancre et d'échappement démontable, barillet démontable  
Despertador, 30 horas cuerda, puentes para el áncora y volante a desmontar, barillete intercambiable



Platinen - Plates - Platines - Platinas 50 x 42 mm = 2 x 1 1/2 inches

No. J 44

Gut regulierendes 8 Tag Ankergehwerk  
Well regulated 8 day lever time movement  
Mouvement 8 jours simple, échappement à ancre, avec bon réglage  
Máquina 8 días cuerda, escape á áncora. Bien ajustado



6,5 x 6,5 cm = 2 1/2 x 2 1/2 inches

5/238 Z RZ

1 Tag flaches Weckerwerk - 1 day alarm - 30 heures réveil - Despertador, 30 horas cuerda

5/239 Z

8 Tag Ankergehwerk - 8 day lever time movement

Mouvement 8 jours simple, échappement à ancre - Máquina 8 días cuerda, escape á áncora

Verchromt poliert, Silberblatt - Chromium plated, polished, silver dial

Chromé, poli, cadran argenté - Cromado, pulido, esfera plateada



6,5 x 6,5 cm = 2 1/2 x 2 1/2 inches

5/238 S RZ

5/239 S

8 Tag Ankergehwerk - 8 day lever time movement

Mouvement 8 jours simple, échappement à ancre - Máquina 8 días cuerda, escape á áncora

Verchromt poliert, Silberblatt - Chromium plated, polished, silver dial

Chromé, poli, cadran argenté - Cromado, pulido, esfera plateada



8 x 8 cm = 3 1/8 x 3 1/8 inches

5/215 Z RZ

1 Tag flaches Weckerwerk - 1 day alarm  
30 heures réveil - Despertador, 30 horas cuerda

5/216 Z

8 Tag Ankergehwerk - 8 day lever time movement  
Mouvement 8 jours simple, échappement à ancre - Máquina 8 días cuerda, escape á áncora



8 x 8 cm = 3 1/8 x 3 1/8 inches

5/215 S RZ

1 Tag flaches Weckerwerk - 1 day alarm  
30 heures réveil - Despertador, 30 horas cuerda

5/216 S

8 Tag Ankergehwerk - 8 day lever time movement  
Mouvement 8 jours simple, échappement à ancre - Máquina 8 días cuerda, escape á áncora



10 x 10 cm = 4 x 4 inches

5/217 Z RZ

1 Tag flaches Weckerwerk - 1 day alarm  
30 heures réveil - Despertador, 30 horas cuerda

5/218 Z

8 Tag Ankergehwerk - 8 day lever time movement  
Mouvement 8 jours simple, échappement à ancre - Máquina 8 días cuerda, escape á áncora



10 x 10 cm = 4 x 4 inches

5/217 S RZ

1 Tag flaches Weckerwerk - 1 day alarm  
30 heures réveil - Despertador, 30 horas cuerda

5/218 S

8 Tag Ankergehwerk - 8 day lever time movement  
Mouvement 8 jours simple, échappement à ancre - Máquina 8 días cuerda, escape á áncora

Verchromt poliert, Silberblatt - Chromium plated, polished, silver dial  
Chromé, poli, cadran argenté - Cromado, pulido, esfera plateada



7,5 x 11 cm = 3 x 4 1/4 inches

**5/193 1 Tag Weckerwerk** - 1 day alarm - 30 heures réveil  
Despertador, 30 horas cuerda

**5/199 8 Tag Ankergehwerk** - 8 day lever time movement - Mouvement 8 jours simple, échappement à ancre - Máquina 8 días cuerda, escape á âncora

**Verchromt poliert, Silberblatt**  
Chromium plated, polished, silver dial  
Chromé, poli, cadran argenté  
Cromado, pulido, esfera plateada



10 x 10 cm = 4 x 4 inches

**5/197 Verchromt poliert, Silberblatt, weiß polierte Striche**  
Chromium plated polished, silver dial, polished white strokes

**Chromé poli, cadran argenté, barres blanches polies**  
Cromado pulido, esfera plateada, rayas blancas pulidas

**8 Tag Ankergehwerk**  
8 day lever time movement  
8 jours simple, échappement à ancre  
Máquina 8 días cuerda, escape á âncora



13 x 13 cm = 5 1/4 x 5 1/4 inches

**5/190 Verchromt poliert, Silberblatt** - Chromium plated, polished, silver dial - Chromé, poli, cadran argenté - Cromado, pulido, esfera plateada

**8 Tag Ankergehwerk** - 8 day lever time movement  
8 jours simple, échappement à ancre - Máquina 8 días cuerda, escape á âncora



14 x 14 cm = 5 1/2 x 5 1/2 inches

**5/200 Silberblatt, blau polierte Striche** - Silver dial, polished blue strokes - Cadran argenté, barres bleues polies - Esfera plateada, rayas azules pulidas

**Verchromt poliert** - Chromium plated, polished  
Chromé, poli - Cromado, pulido



7,5 x 13 cm = 3 x 5 1/4 inches

**Rahmen - Frame - Cadre - Marco** 6,5 x 6,5 cm = 2 1/2 x 2 1/2 inches

**5/240 Z RZ**

**1 Tag flaches Weckerwerk** - 1 day alarm - 30 heures réveil - Despertador, 30 horas cuerda

**5/241 Z**

**8 Tag Ankergehwerk** - 8 day lever time movement - Mouvement 8 jours simple, échappement à ancre  
Máquina 8 días cuerda, escape á âncora

**Verchromt poliert, Silberblatt, drehbarer Rahmen**  
Chromium plated, polished, silver dial, movable frame - Chromé, poli, cadran argenté, cadre mobile  
Cromado, pulido, esfera plateada, marquito movable



7,5 x 13 cm = 3 x 5 1/4 inches

**5/240 S RZ**

**5/241 S**



9,5 x 11 cm = 3 3/4 x 4 1/4 inches

**Rahmen - Frame - Cadre - Marco** 8 x 8 cm = 3 1/8 x 3 1/8 inches

**5/229 Z RZ**

**1 Tag flaches Weckerwerk** - 1 day alarm - 30 heures réveil - Despertador, 30 horas cuerda

**5/230 Z**

**8 Tag Ankergehwerk** - 8 day lever time movement - Mouvement 8 jours simple, échappement à ancre  
Máquina 8 días cuerda, escape á âncora

**Verchromt poliert, Silberblatt** - Chromium plated, polished, silver dial  
Chromé, poli, cadran argenté - Cromado, pulido, esfera plateada



9,5 x 11 cm = 3 3/4 x 4 1/4 inches

**5/229 S RZ**

**5/230 S**



11 x 19,5 cm = 4 1/4 x 7 3/4 inches

Rahmen - Frame - Cadre - Marco 10 x 10 cm = 4 x 4 inches

5,242 Z RZ 1 Tag flaches Weckerwerk - 1 day alarm  
30 heures réveil - Despertador, 30 horas cuerda

5,243 Z 8 Tag Ankergehwerk - 8 day lever time movement  
Mouvement 8 jours simple, échappement à ancre  
Máquina 8 días cuerda, escape á áncora



11 x 19,5 cm = 4 1/4 x 7 3/4 inches

Rahmen - Frame - Cadre - Marco 10 x 10 cm = 4 x 4 inches

5,242 S RZ 1 Tag flaches Weckerwerk - 1 day alarm  
30 heures réveil - Despertador, 30 horas cuerda

5,243 S 8 Tag Ankergehwerk - 8 day lever time movement  
Mouvement 8 jours simple, échappement à ancre  
Máquina 8 días cuerda, escape á áncora

Verchromt poliert, Silberblatt, drehbarer Rahmen  
Chromium plated, polished, silver dial, movable frame  
Chromé, poli, cadran argenté, cadre mobile  
Cromado, pulido, esfera plateada, marquito movable



9 x 16 cm = 3 1/2 x 6 1/4 inches

5,219 Z RZ 1 Tag Weckerwerk - 1 day alarm  
30 heures réveil - Despertador, 30 horas cuerda

5,220 Z 8 Tag Ankergehwerk - 8 day lever time movement  
Mouvement 8 jours simple, échappement à ancre - Máquina 8 días cuerda, escape á áncora

Verchromt poliert, Silberblatt, drehbarer Rahmen  
Chromium plated, polished, silver dial, movable frame  
Chromé, poli, cadran argenté, cadre mobile  
Cromado, pulido, esfera plateada, marquito movable



9 x 16 cm = 3 1/2 x 6 1/4 inches

5,220 S 8 Tag Ankergehwerk - 8 day lever time movement  
Mouvement 8 jours simple, échappement à ancre - Máquina 8 días cuerda, escape á áncora



9 x 14 cm = 3 1/2 x 5 1/2 inches

5,223 Z RZ 1 Tag Weckerwerk - 1 day alarm  
30 heures réveil - Despertador, 30 horas cuerda

5,224 Z 8 Tag Ankergehwerk - 8 day lever time movement  
Mouvement 8 jours simple, échappement à ancre - Máquina 8 días cuerda, escape á áncora

Verchromt poliert mit schwarzer Kristallglaseinlage, Silberblatt, drehbarer Rahmen  
Chromium plated, polished, with black plate-glass inset, silver dial, movable frame  
Chromé, poli, avec applique en verre noire, cadre mobile  
Cromado, pulido, con vidrio negro, esfera plateada, marquito movable



9 x 14 cm = 3 1/2 x 5 1/2 inches

5,224 S 8 Tag Ankergehwerk - 8 day lever time movement  
Mouvement 8 jours simple, échappement à ancre - Máquina 8 días cuerda, escape á áncora



9 x 20 cm = 3 1/2 x 8 inches

- 5/225 Z RZ** 1 Tag Wecker - 1 day alarm  
30 heures réveil - Despertador, 30 horas cuerda
- 5/226 Z** 8 Tag Ankergehwerk - 8 day lever time movement  
Mouvement 8 jours simple, échappement à ancre  
Máquina 8 días cuerda, escape á áncora



9 x 20 cm = 3 1/2 x 8 inches

- 5/225 S RZ** 1 Tag Wecker - 1 day alarm  
30 heures réveil - Despertador, 30 horas cuerda
- 5/226 S** 8 Tag Ankergehwerk - 8 day lever time movement  
Mouvement 8 jours simple, échappement à ancre  
Máquina 8 días cuerda, escape á áncora

Verchromt poliert, Silberblatt, drehbarer Rahmen - Chromium plated, polished, silver dial, movable frame  
Chromé, poli, cadran argenté, cadre mobile - Cromado, pulido, esfera plateada, marquito movable



9 x 25 cm = 3 1/2 x 9 7/8 inches

- 5/227 Z RZ** 1 Tag Wecker - 1 day alarm  
30 heures réveil - Despertador, 30 horas cuerda
- 5/228 Z** 8 Tag Ankergehwerk - 8 day lever time movement  
Mouvement 8 jours simple, échappement à ancre  
Máquina 8 días cuerda, escape á áncora



9 x 25 cm = 3 1/2 x 9 7/8 inches

- 5/227 S RZ** 1 Tag Wecker - 1 day alarm  
30 heures réveil - Despertador, 30 horas cuerda
- 5/228 S** 8 Tag Ankergehwerk - 8 day lever time movement  
Mouvement 8 jours simple, échappement à ancre  
Máquina 8 días cuerda, escape á áncora

Verchromt poliert mit schwarzer Kristallglas-Einlage, Silberblatt  
Chromium plated, polished, with black plate-glass inset, silver dial  
Chromé, poli, avec applique en verre noire, cadran argenté  
Cromado, pulido, con vidrio negro, esfera plateada



17 x 15,5 cm = 6 3/4 x 6 1/8 inches

**5/209** Verchromt poliert, Silberblatt mit weiß polierten Zahlen  
Chromium plated, polished, silver dial with white polished figures  
Chromé, poli, cadran argenté avec chiffres blancs, polis  
Cromado, pulido, esfera plateada con cifras blancas, pulidas



20 x 15,5 cm = 7 7/8 x 6 1/8 inches

**5/237** Verchromt mit kaukasisch Nußbaum poliert, Silberblatt  
Chromium plated with polished Caucasian walnut, silver dial  
Chromé avec noyer Caucasiens poli, cadran argenté  
Cromado con nogal Caúcaso pulido, esfera plateada

**8 Tag Ankergehwerk - 8 day lever time movement**  
Mouvement 8 jours simple, échappement à ancre - Máquina, 8 días cuerda, escape á áncora



GRUPPE 6

*Boudoir-Uhren mit einfachem Ankerwerk*

Boudoir clocks - Pendulettes de boudoir - Relojes para tocador

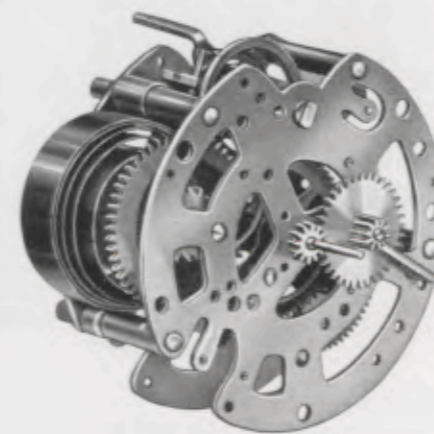

Platinen - Plates - Platines - Platinas

54 mm = 2 1/8 inches

**No. 59**

**1 Tag Gehwerk - 1 day time**  
30 heures simple - 30 horas cuerda



Platinen - Plates - Platines - Platinas

54 mm = 2 1/8 inches

**No. 60**

**1 Tag Wecker - 1 day alarm**  
30 heures réveil - 30 horas despertador



6,5 x 6,5 cm = 2 1/2 x 2 1/2 inches

**6/27 1 Tag Gehwerk**  
1 day time  
30 heures simple  
30 horas cuerda

**6/28 1 Tag Wecker**  
1 day alarm  
30 heures réveil  
30 horas despertador



8 x 8 cm = 3 1/8 x 3 1/8 inches

**6/17 1 Tag Gehwerk - 1 day time**  
30 heures simple - 30 horas cuerda

**6/18 1 Tag Wecker - 1 day alarm**  
30 heures réveil - 30 horas despertador

Verchromt, Silberblatt  
Chromium plated, silver dial  
Chromé, cadran argenté  
Cromado, esfera plateada



10 x 10 cm = 4 x 4 inches

**6/19 1 Tag Gehwerk - 1 day time**  
30 heures simple - 30 horas cuerda

**6/20 1 Tag Wecker - 1 day alarm**  
30 heures réveil - 30 horas despertador



9,5 x 11 cm = 3 7/8 x 4 3/8 inches



9,5 x 12 cm = 3 7/8 x 4 7/8 inches

Rahmen - Frame - Cadre - Marco

8 x 8 cm = 3 1/8 x 3 1/8 inches

8 x 8 cm = 3 1/8 x 3 1/8 inches

6/21 1 Tag Gehwerk - 1 day time  
30 heures simple - 30 horas cuerda

6/22 1 Tag Wecker - 1 day alarm  
30 heures réveil - 30 horas despertador

Verchromt, Silberblatt

Chromium plated, silver dial

Chromé, cadran argenté

Cromado, esfera plateada

6/29 1 Tag Gehwerk - 1 day time  
30 heures simple - 30 horas cuerda

6/30 1 Tag Wecker - 1 day alarm  
30 heures réveil - 30 horas despertador

Verchromt, Silberblatt, drehbarer Rahmen

Chromium plated, silver dial, movable frame

Chromé, cadran argenté, cadre mobile

Cromado, esfera plateada, marquito movable



11,5 x 15 cm = 4 1/2 x 6 inches

Rahmen - Frame - Cadre - Marco 10 x 10 cm = 4 x 4 inches

6/31 Z Zahlen - Figures - Chiffres - Cifras

6/31 S Striche - Strokes - Barres - Rayas

1 Tag Gehwerk - 1 day time  
30 heures simple - 30 horas cuerda

6/32 Z Zahlen - Figures - Chiffres - Cifras

6/32 S Striche - Strokes - Barres - Rayas

1 Tag Wecker - 1 day alarm  
30 heures réveil - 30 horas despertador

Verchromt, Silberblatt, drehbarer Rahmen - Chromium plated, silver dial, movable frame

Chromé, cadran argenté, cadre mobile - Cromado, esfera plateada, marquito movable



13 x 13 cm = 5 1/4 x 5 1/4 inches



12,5 x 15,5 cm = 4 7/8 x 6 inches

6/3 1 Tag Gehwerk - 1 day time  
30 heures simple - 30 horas cuerda

6/4 1 Tag Wecker - 1 day alarm  
30 heures réveil - 30 horas despertador

6/5 1 Tag Gehwerk - 1 day time  
30 heures simple - 30 horas cuerda

6/6 1 Tag Wecker - 1 day alarm  
30 heures réveil - 30 horas despertador

Chromrahmen, Silberblatt - Chromium plated frame, silver dial  
Cadre chromé, cadran argenté - Marquito cromado, esfera plateada

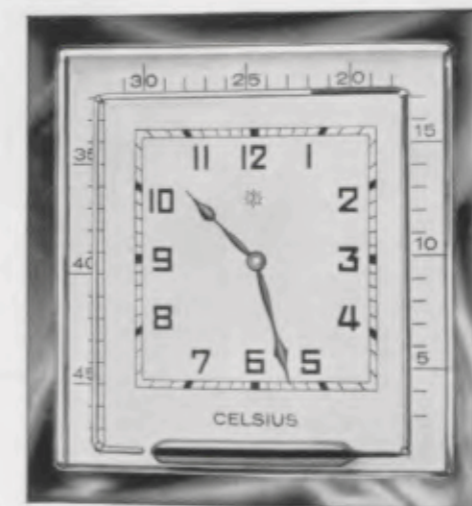

13 x 13 cm = 5 1/4 x 5 1/4 inches

6/16 1 Tag Wecker - 1 day alarm - 30 heures réveil - 30 horas despertador

Mit Celsius und Fahrenheit lieferbar - Can be had with Celsius and Fahrenheit  
Livvable en Celsius et Fahrenheit - Se hace en Celsius y Fahrenheit

Chromrahmen, Silberblatt mit Thermometer - Chromium plated frame, silver dial with thermometer  
Cadre chromé, cadran argenté avec thermomètre - Marquito cromado, esfera plateada con termómetro



GRUPPE 54

Miniatur-Wecker mit Hohltriebwerk ohne Federhaus

Miniature-Alarms, movement with lantern pinions, without spring barrel - Réveils miniature, mouvement avec pignons lanternes, sans barillet - Despertadores miniatura, máquina con piñones de linterna, sin barillete

Primus I



8,5 cm = 3 1/4 inches

54/1 1 Tag Gehwerk - 1 day time - 30 heures simple - 30 horas cuerda

Zinkgehäuse vernickelt, weiß Kartonblatt  
Zinc case nickelled, white cardboard dial  
Boîte zinc nickelé, cadran carton blanc  
Caja de zinc niquelado, esfera blanca de cartón

Primus II



10,5 cm = 4 1/8 inches

54/3 1 Tag Wecker - 1 day alarm - 30 heures réveil - 30 horas despertador

Zinkgehäuse vernickelt, weiß Kartonblatt  
Zinc case nickelled, white cardboard dial  
Boîte zinc nickelé, cadran carton blanc  
Caja de zinc niquelado, esfera blanca de cartón

Desk I



10 cm = 4 inches

54/12 1 Tag Gehwerk - 1 day time - 30 heures simple - 30 horas cuerda

Messinggehäuse vernickelt, Zelluloidblatt  
Brass case nickelled, celluloid dial  
Boîte laiton nickelé, cadran celluloïde  
Caja de latón niquelado, esfera de celuloide

Desk II



12 cm = 4 3/4 inches

54/13 1 Tag Wecker - 1 day alarm - 30 heures réveil - 30 horas despertador

Messinggehäuse vernickelt, Silberblatt  
Brass case nickelled, silver dial  
Boîte laiton nickelé, cadran argenté  
Caja de latón niquelado, esfera plateada

Kalender

14 cm = 5 1/2 inches



54/11 Metallgehäuse vernickelt, Silberblatt - Metal case nickelled, silver dial - Boîte métal nickelé, cadran argenté - Caja de metal niquelado, esfera plateada

54/161 Metallgehäuse rotbraun, Weißblatt - Claret coloured metal case, white cardboard dial - Boîte métal brun-rouge, cadran carton blanc - Caja de metal rojo oscuro, esfera blanca de cartón

1 Tag Gehwerk - 1 day time - 30 heures simple - 30 horas cuerda



Azur



8 x 8 cm = 3 1/8 x 3 1/8 inches

54/121 1 Tag Wecker - 1 day alarm - 30 heures réveil - 30 horas despertador

Verchromtes Metallgehäuse mit blau lackiertem Band - Chromium plated metal case with blue band - Boîte métal chromé avec ruban bleu - Caja de metal cromado y azul



7 x 13 cm = 2 3/4 x 5 1/8 inches

54/122

Verchromt poliert, Silberblatt - Chromium plated, polished, silver dial  
Chromé, poli, cadran argenté - Cromado, pulido, esfera plateada



7 x 15 cm = 2 3/4 x 6 inches

54/123

Start



8 cm = 3 1/8 inches

54/101 Metallgehäuse hellrot - Metal case light red  
Boîte métal rouge clair - Caja de metal rojo claro

54/102 Metallgehäuse blau - Blue metal case  
Boîte métal bleu - Caja de metal azul

54/119 Metallgehäuse verchromt, Silberblatt  
Chromium plated metal case, silver dial  
Boîte métal chromé, cadran argenté  
Caja de metal cromado, esfera plateada

Bügelabsteller - The alarm is stopped by pushing the handle down - Arrêtage du réveil par la poignée - El despertador se para doblando la manija

54/124 Metallgehäuse vernickelt mit blau lackiertem Band - Nickelated metal case with blue lacquered band - Boîte métal nickelé avec ruban bleu - Caja de metal niquelado y azul

Silberblatt - Silver dial  
Cadran argenté - Esfera plateada

1 Tag Wecker - 1 day alarm  
30 heures réveil - Despertador, 30 horas cuerda

Gloria



8 x 6 cm = 3 x 2 1/4 inches

54/104 Metallgehäuse verchromt, Silberblatt  
Chromium plated metal case, silver dial  
Boîte métal chromé, cadran argenté  
Caja de metal cromado, esfera plateada

54/105 Metallgehäuse rotbraun - Claret coloured metal case - Boîte métal brun-rouge - Caja de metal rojo oscuro

54/107 Metallgehäuse blau - Blue metal case  
Boîte métal bleue - Caja de metal azul

Karton-Goldblatt - Gilt cardboard dial  
Cadran carton doré - Esfera dorada de cartón

Bügelabsteller - The alarm is stopped by pushing the handle down - Arrêtage du réveil par la poignée - El despertador se para doblando la manija



8,5 x 12 cm = 3 3/8 x 4 7/8 inches

54/244 Eiche - Oak - Chêne - Roble

Chromlünette, weißes Kartonblatt  
Chromium plated bezel, white cardboard dial - Lunette chromée, cadran carton blanc - Bisel cromado, esfera blanca de cartón



8,5 x 12 cm = 3 3/8 x 4 7/8 inches

54/246 Nußbaum poliert - Polished walnut  
Noyer poli - Nogal pulido

54/247 Mahagoni - Mahogany - Acajou - Caoba

Goldbronzierte Lünette und Kartonblatt  
Gold bronze bezel and cardboard dial  
Lunette et cadran carton bronze doré  
Bisel y esfera de cartón bronce dorada



8,5 x 12 cm = 3 3/8 x 4 7/8 inches

54/248 Eiche - Oak - Chêne - Roble

Chromlünette, weißes Kartonblatt - Chromium plated bezel, white cardboard dial  
Lunette chromée, cadran carton blanc - Bisel cromado, esfera blanca de cartón



9,5 x 13 cm = 3 3/4 x 5 1/8 inches

54/249 Eiche - Oak - Chêne - Roble



9,5 x 13 cm = 3 3/4 x 5 1/8 inches

54/250 Nußbaum poliert - Polished walnut  
Noyer poli - Nogal pulido

Chromlünette, weißes Kartonblatt - Chromium plated bezel, white cardboard dial  
Lunette chromée, cadran carton blanc - Bisel cromado, esfera blanca de cartón



8 x 13 cm = 3 1/4 x 5 1/8 inches

54/251 Nußbaum poliert - Polished walnut  
Noyer poli - Nogal pulido

1 Tag Weckerwerk ohne Federhäuser - 1 day alarm movement without spring barrels  
Mouvement 30 heures réveil sans barillet - Despertador 30 horas cuerda, sin barilletes

Mit oder ohne Radium-Ausstattung (RZ) - With or without luminous figures (RZ)  
Avec ou sans chiffres lumineux Radium (RZ) - Con ó sin cifras luminosas Radium (RZ)



GRUPPE 7

Miniatur-Wecker, Hohltriebwerk mit Federhaus

Miniature-Alarms, movement with lantern pinions and spring barrels - Réveils miniature, mouvement avec pignons lanternes et barillet - Despertadores miniatura, máquina con piñones de linterna y con barillete

Neu-Triumph



7 x 6 cm = 2 3/4 x 2 1/4 inches

Messinggehäuse - Brass case - Boîte laiton  
Caja de latón

7/195 Vernickelt - Nickelled - Nickelé - Niquelado  
Silberblatt - Silver dial - Cadran argenté  
Esfera plateada

7/196 Bordorot - Claret coloured - Rouge Bordeaux  
Color Burdeos  
Goldblatt - Gilt dial - Cadran doré  
Esfera dorado



9,5 x 14 cm = 3 3/4 x 5 1/2 inches

7/323 Kaukasisch Nußbaum poliert - Polished  
Caucasian walnut - Noyer Caucasien poli  
Nogal Caúcaso pulido



9,5 x 17 cm = 3 3/4 x 6 3/4 inches

7/324 Kaukasisch Nußbaum poliert - Polished  
Caucasian walnut - Noyer Caucasien poli  
Nogal Caúcaso pulido

Chromlünette, Silberblatt - Chromium plated bezel, silver dial - Lunette chromée, cadran argenté  
Bisel cromado, esfera plateada

1 Tag Wecker - 1 day alarm - 30 heures réveil - Despertador, 30 horas cuerda





GRUPPEN 8 und 56

*Wecker in Metallgehäusen*

Alarm clocks in metal cases – Réveils en boîtes métal  
Despertadores en cajas de metal

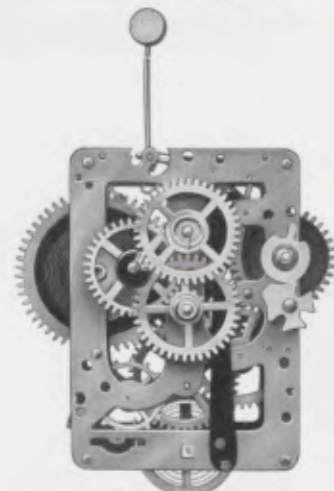

**No. 10** Großes Werk  
Large movement  
Grand mouvement  
Máquina grande

8,2 x 5,8 cm = 3 1/4 x 2 1/4 inches

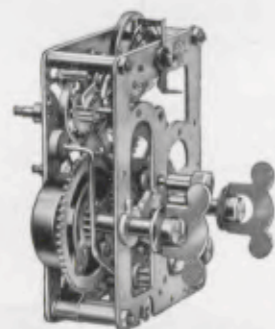

**No. 10 G** Großes Werk, lautlos  
Large movement, silent  
Grand mouvement, silencieux  
Máquina grande, silenciosa

8,2 x 5,8 cm = 3 1/4 x 2 1/4 inches

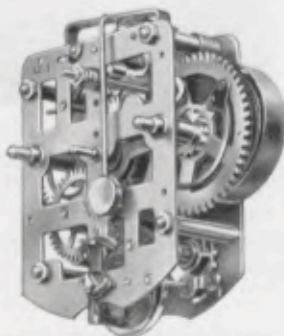

**No. 231** Kleines Werk, große Balance  
Small movement, large balance  
Petit mouvement, grand balancier  
Máquina pequeña, volante grande

**No. 231 L** Kleines Werk, große Balance, leise tickend  
Small movement, large balance, soft ticking  
Petit mouvement, grand balancier, à tic tac doux  
Máquina pequeña, volante grande, à tique taque bajo

**No. 231 G** Kleines Werk, große Balance, lautlos  
Small movement, large balance, silent  
Petit mouvement, grand balancier, silencieux  
Máquina pequeña, volante grande, silenciosa

7,1 x 5,6 cm = 2 7/8 x 2 1/4 inches

Die weltberühmten Weckerwerke – The world-renowned alarm movements  
Les mouvements de réveils à réputation mondiale – Las máquinas de despertares de fama mundial



Globe



16 cm = 6 1/4 inches

**8/191** Metallgehäuse vernickelt – Metal case nickelled  
Boîte métal nickelé – Caja de metal niquelado

Globe



16 cm = 6 1/4 inches

**8/246** Rotbraun – Claret coloured – Brun-rouge  
Rojo oscuro

**8/247** Blau – Blue – Bleu – Azul  
Glocke vernickelt – Nickelled bell  
Cloche nickelée – Campana niquelada

Baby



18 cm = 7 inches

**8/98** Metallgehäuse vernickelt – Metal case nickelled  
Boîte métal nickelé – Caja de metal niquelado

**8/234** Rotbraun – Claret coloured – Brun-rouge  
Rojo oscuro

**8/235** Blau – Blue – Bleu – Azul

**8/236** Grün – Green – Vert – Verde

Stella



18 cm = 7 inches

**8/100** Metallgehäuse vernickelt – Metal case nickelled  
Boîte métal nickelé – Caja de metal niquelado

**8/100 M** Messinggehäuse vernickelt – Brass case nickelled  
Boîte laiton nickelé – Caja de latón niquelado

Staubdichter Regulierschütz – Dustproof regulating-slot – Fente de réglage hermétique – Hendrija de ajustamiento hermética

**8/99** Metallgehäuse vernickelt – Metal case nickelled  
Boîte métal nickelé – Caja de metal niquelado

Kleines Werk – Small movement – Petit mouvement – Máquina pequeña



Tommy



18 cm = 7 inches

8/228 Metallgehäuse vernickelt - Metal case nickelled  
Boîte métal nickelé - Caja de metal niquelado  
1 Tag Wecker, kleines Werk - 1 day alarm,  
small movement - 30 heures réveil, petit mouve-  
ment - 30 horas despertador, máquina pequeña

Baby



10 cm = 7 inches

8/242 Metallgehäuse vernickelt - Metal case nickelled  
Boîte métal nickelé - Caja de metal niquelado  
8/242 M Messinggehäuse vernickelt - Brass case nickelled  
Boîte laiton nickelé - Caja de latón niquelado  
Großes Werk, staubdichter Regulierschlitze  
Large movement, dustproof regulating-slot  
Grand mouvement, fente de réglage hermétique  
Máquina grande, hendrija de ajustamiento  
hermética

Junghans-Baby



19 cm = 7 1/2 inches

8/2 Metallgehäuse vernickelt - Metal case nickelled  
Boîte métal nickelé - Caja de metal niquelado  
8/2 M Messinggehäuse vernickelt - Brass case nickelled  
Boîte laiton nickelé - Caja de latón niquelado  
Weißes Kartonblatt - White cardboard dial  
Cadran carton blanc - Esfera blanca de cartón  
Großes Werk, staubdichte Messing- oder Zellu-  
loidrückwand - Large movement, dustproof  
brass or celluloid back - Grand mouvement, fond  
laiton ou fond celluloidé hermétiques - Máquina  
grande, respaldo hermético de latón ó celuloide



11 cm = 4 1/4 inches

8/333 Metallgehäuse rotbraun, Sockel verchromt  
Claret coloured metal case, chromium plated base  
Boîte métal brun-rouge, socle chromé  
Caja de metal rojo oscuro, zócalo cromado  
8/336 Zahlen - Figures - Chiffres - Cifras  
8/337 Striche - Strokes - Barres - Rayas  
Verchromt mit blau emailliertem Band  
Chromium plated with blue enameled centre-band  
Chromé avec bande émaillée bleue  
Cromado con cinta esmaltada azul  
1 Tag Wecker, kleines Werk  
1 day alarm, small movement  
30 heures réveil, petit mouvement  
30 horas despertador, máquina pequeña



Globe



14 cm = 5 1/4 inches

- 8/190** **Gehwerk** - Time movement  
Mouvement simple - Movimiento solo  
**Metallgehäuse vernickelt** - Metal case nickelled  
Boîte métal nickelé - Caja de metal niquelado

Globe



13,5 cm = 5 1/4 inches

- 8/276** **Rotbraun** - Claret coloured  
Brun-rouge - Rojo oscuro  
**8/277** **Blau** - Blue - Bleu - Azul  
**8/278** **Grün** - Green - Vert - Verde  
**8/309** **Vernickelt** - Nickelled - Nickelé - Niquelado  
**Schlag auf Rückwand** - Strike on back  
Sonnerie sur fond - Tocando en el respaldo  
**1 Tag Wecker, kleines Werk**  
1 day alarm, small movement  
30 heures réveil, petit mouvement  
30 horas despertador, máquina pequeña

Bravetto



12 cm = 4 3/4 inches

- 8/209** **Blau** - Blue - Bleu - Azul  
**8/210** **Grün** - Green - Vert - Verde  
**8/211** **Rotbraun** - Claret coloured - Brun-rouge  
Rojo oscuro  
**8/184** **Verchromt** - Chromium plated - Chromé  
Cromado  
**Weißes Kartonblatt** - White cardboard dial  
Cadran carton blanc - Esfera blanca de cartón  
**8/184:** **Auch mit Silberblatt lieferbar** - Can also be had  
with silver dial - Se livre aussi avec cadran  
argenté - Se hace tambien con esfera plateada

Neu-Bravetto



10,5 cm = 4 1/8 inches

- Metallgehäuse rotbraun**  
Claret coloured metal case  
Boîte métal brun-rouge  
Caja de metal rojo oscuro  
**8/266** **Zahlen** - Figures - Chiffres - Cifras  
**8/267** **Striche** - Strokes - Barres - Rayas

**1 Tag Wecker, Schlag auf Rückwand** - 1 day alarm, strike on back  
30 heures réveil, sonnerie sur fond - 30 horas despertador, tocando en el respaldo



Neu-Bravetto



10,5 cm = 4 1/8 inches

Metallgehäuse verchromt mit blau emailliertem Band - Chromium plated metal case with blue enamelled centre-band - Boîte métal chromé avec bande émaillée bleue - Caja de metal cromada con cinta esmaltada azul

8/284 Zahlen - Figures - Chiffres - Cifras

8/285 Striche - Strokes - Barres - Rayas

Silberblatt - Silver dial - Cadran argenté  
Esfera plateada

1 Tag Wecker - 1 day alarm  
30 heures réveil - 30 horas despertador

Boxer



12 cm = 4 3/4 inches

8/213 Vernickelt - Nickelled - Nickelé - Niquelado

8/214 Grün - Green - Vert - Verde

8/215 Blau - Blue - Bleu - Azul

8/216 Rotbraun - Claret coloured - Brun-rouge  
Rojo oscuro

Mit Repetition - Repeating alarm  
Avec répétition - Con repetición

8/307 Vernickelt - Nickelled - Nickelé - Niquelado

8/308 Rotbraun - Claret coloured - Brun-rouge  
Rojo oscuro

1 Tag Wecker, kleines Werk, Rückwandglocke  
1 day alarm, small movement, back bell  
30 heures réveil, petit mouvement, timbre fond  
30 horas despertador, máquina pequeña, campana en el respaldo

Regent I



12,5 cm = 5 inches

8/217 Blau - Blue - Bleu - Azul

8/218 Rotbraun - Claret coloured - Brun-rouge  
Rojo oscuro

8/219 Verchromt - Chromium plated - Chromé  
Cromado

Weißes Kartonblatt - White cardboard dial - Cadran carton blanc - Esfera blanca de cartón

8/219, 8/295: Auch mit Silberblatt lieferbar - Can also be had with silver dial - Se livre aussi avec cadran argenté  
Se hace tambien con esfera plateada

Kleines Werk - Small movement - Petit mouvement - Máquina pequeña

Regent II



11 cm = 4 1/4 inches

8/293 Blau - Blue - Bleu - Azul

8/294 Rotbraun - Claret coloured - Brun-rouge  
Rojo oscuro

8/295 Verchromt - Chromium plated - Chromé  
Cromado

Rückwandglocke - Back bell - Timbre fond  
Campana en el respaldo



Bravo



14,5 cm = 5 3/4 inches

8/197 Vernickelt - Nickelled - Nickelé - Niquelado

8/198 Blau - Blue - Bleu - Azul

8/199 Grün - Green - Vert - Verde

8/200 Rotbraun - Claret coloured - Brun-rouge  
Rojo oscuro

8/233 Verchromt - Chromium plated - Chromé  
Cromado

1 Tag Wecker, Schlag auf Rückwand - 1 day alarm, strike on back - 30 heures réveil, sonnerie sur fond - 30 horas despertador, tocando en el respaldo

8/201 Mit Repetition - Repeating alarm  
Avec répétition - Con repetición

Rotbraun - Claret coloured - Brun-rouge  
Rojo oscuro

Kleines Werk - Small movement - Petit mouvement - Máquina pequeña

Bravo auf Sockel



14 x 12 cm = 5 1/2 x 4 3/4 inches

Reißlack - Crackle colour - Verni craquelé  
Barniz rompiente

8/202 Blau mit schwarz - Blue with black - Bleu et noir - Azul y negro

8/204 Hellbraun mit Gold - Brown with gold - Brun clair et doré - Moreno claro y oro

1 Tag Wecker, Schlag auf Rückwand - 1 day alarm, strike on back - 30 heures réveil, sonnerie sur fond - 30 horas despertador, tocando en el respaldo

Bravo J



14 cm = 5 1/2 inches

8/220 Metallgehäuse grün - Metal case green  
Boîte métal vert - Caja de metal verde

8/221 Metallgehäuse blau - Metal case blue  
Boîte métal bleu - Caja de metal azul

8/222 Metallgehäuse rotbraun - Metal case claret coloured - Boîte métal brun-rouge - Caja de metal rojo oscuro

1 Tag Wecker, großes Werk - 1 day alarm, large movement  
30 heures réveil, grand mouvement - 30 horas despertador, máquina grande

Reklame- und Sportuhr „Turner“

Advertising and sport-clock „Gymnast“ - Horloge de réclame et de Sport „Gymnaste“ - Reloj de reclamo y de deporte „Gimnasta“



14,5 cm = 5 3/4 inches

8/188 Rotbraun - Claret coloured - Brun-rouge  
Rojo oscuro

Der Turner führt mit Pausen schwungvolle Übungen am Reck aus - The gymnast performs intermittently smart exercises on the horizontal bar - Le gymnaste exécute à intervalles d'exercices élastics à la barre-fixe - El gimnasta efectua á intervalos bellos ejercicios en la barra alta



Neu-Bravo



12,5 cm = 4 7/8 inches

Metallgehäuse rotbraun - Claret coloured metal case - Boîte métal brun-rouge - Caja de metal rojo oscuro

- 8/270 Zahlen - Figures - Chiffres - Cifras  
8/271 Striche - Strokes - Barres - Rayas

1 Tag Wecker, Schlag auf Glocke - 1 day alarm, strike on bell - 30 heures réveil, sonnerie sur cloche - 30 horas despertador, campana en el fondo

Neu-Bravo



12,5 cm = 4 7/8 inches

Metallgehäuse verchromt - Chromium plated metal case - Boîte métal chromé - Caja de metal cromado

- 8/272 Zahlen - Figures - Chiffres - Cifras  
8/273 Striche - Strokes - Barres - Rayas

Silber- oder Kartonblatt - Silver or cardboard dial - Cadran argenté ou de carton - Esfera plateada ó de cartón

1 Tag Wecker, Schlag auf Glocke - 1 day alarm, strike on bell - 30 heures réveil, sonnerie sur cloche - 30 horas despertador, campana en el fondo

Kleines Werk - Small movement - Petit mouvement - Máquina pequeña

Pionier I



14,5 cm = 5 7/8 inches

- 8/206 Rotbraun - Claret coloured - Brun-rouge  
Rojo oscuro

- 8/207 Vernickelt - Nickelled - Nickelé - Niquelado

1 Tag Wecker, kleines Werk, Rückwandglocke  
1 day alarm, small movement, back bell  
30 heures réveil, petit mouvement, timbre fond  
30 horas despertador, máquina pequeña, campana en el respaldo

Pionier II



15,5 cm = 6 inches

- 8/208 Metallgehäuse vernickelt - Metal case nickelled  
Boîte métal nickelé - Caja de metal niquelado

1 Tag Wecker, kleines Werk, Rückwandglocke,  
abstellbare Repetition - 1 day alarm, small movement,  
back bell, with both continuous and repeating alarm at option - 30 heures réveil, petit mouvement, timbre fond, répétition à volonté  
30 horas despertador, máquina pequeña, campana en el respaldo, repetición á voluntad



Halli I



14 cm = 5 1/2 inches

- 8/223 Messinggehäuse vernickelt - Brass case nickelled  
Boîte laiton nickelé - Caja de latón niquelado

- 8/224 Messinggehäuse bordorot - Brass case claret coloured - Boîte laiton rouge Bordeaux - Caja de latón, esmalte color Burdeos

1 Tag Wecker, großes Werk, Rückwandglocke  
1 day alarm, large movement, back bell - 30 heures réveil, grand mouvement, timbre fond  
30 horas despertador, máquina grande, campana en el respaldo

Halli II



15 cm = 6 inches

- 8/225 Messinggehäuse vernickelt - Brass case nickelled  
Boîte laiton nickelé - Caja de latón niquelado

- 8/226 Messinggehäuse bordorot - Brass case claret coloured - Boîte laiton rouge Bordeaux - Caja de latón, esmalte color Burdeos

1 Tag Wecker, großes Werk, Rückwandglocke, abstellbare Repetition  
1 day alarm, large movement, back bell, with both continuous and repeating alarm at option  
30 heures réveil, grand mouvement, timbre fond, répétition à volonté  
30 horas despertador, máquina grande, campana en el respaldo, repetición á voluntad

Lloyd II



17 cm = 6 3/4 inches

- 8/227 Metallgehäuse vernickelt - Metal case nickelled  
Boîte métal nickelé - Caja de metal niquelado



*Junghans „Silent-tic“, der leise tickende Wecker*

The alarm with soft tick - Le réveil à tic-tac doux  
El despertador á tique-taque bajo



10,5 cm = 4 1/4 inches

**Metallgehäuse rotbraun**  
Claret coloured metal case - Boîte métal brun-rouge  
Caja de metal rojo oscuro

- 8/316 Zahlen - Figures - Chiffres - Cifras
- 8/317 Striche - Strokes - Barres - Rayas



10,5 cm = 4 1/4 inches

**Metallgehäuse verchromt mit blau emailliertem Band**  
Chromium plated metal case with blue enameled centre-band  
Boîte métal chromé avec bande émaillée bleue  
Caja de metal cromada con cinta esmaltada azul

- 8/318 Zahlen - Figures - Chiffres - Cifras
- 8/319 Striche - Strokes - Barres - Rayas



12 cm = 4 3/4 inches

- 8/321 Rotbraun - Claret coloured - Brun-rouge  
Rojo oscuro
- 8/322 Vernickelt - Nickelled - Nickelé - Niquelado



12 cm = 4 3/4 inches

- 8/340 Vernickelt - Nickelled - Nickelé - Niquelado
- 8/341 Rotbraun - Claret coloured - Brun-rouge  
Rojo oscuro

**Mit Repetition** - Repeating alarm - Avec répétition - Con repetición

- 8/342 Vernickelt - Nickelled - Nickelé - Niquelado
- 8/343 Rotbraun - Claret coloured - Brun-rouge  
Rojo oscuro

**Rückwandglocke** - Back bell - Timbre fond  
Campana en el respaldo

1 Tag Weckerwerk No. 231 L - 1 day alarm movement No. 231 L  
30 heures réveil mouvement No. 231 L - Despertador, 30 horas cuerda, No. 231 L



*Junghans „Silent-tic“, der leise tickende Wecker*

The alarm with soft tick - Le réveil à tic-tac doux  
El despertador á tique-taque bajo



14,5 cm = 5 3/4 inches

- 8/344 Vernickelt - Nickelled - Nickelé - Niquelado
- 8/345 Rotbraun - Claret coloured - Brun-rouge  
Rojo oscuro

**Schlag auf Rückwand** - Strike on back  
Sonnerie sur fond - Tocando en el respaldo



12,5 cm = 4 7/8 inches

- 8/346 Zahlen - Figures - Chiffres - Cifras
- 8/347 Striche - Strokes - Barres - Rayas

**Silberblatt** - Silver dial - Cadran argenté  
Esfera plateada

**Schlag auf Innenglocke** - Strike on back bell  
Timbre fond - Campana en el respaldo



11 cm = 4 1/4 inches

- 8/331 Zahlen - Figures - Chiffres - Cifras
- 8/332 Striche - Strokes - Barres - Rayas

**Metallgehäuse rotbraun** - Claret coloured metal case - Boîte métal brun-rouge - Caja de metal rojo oscuro

**Verchromt mit blau emailliertem Band** - Chromium plated with blue enameled centre-band  
Chromé avec bande émaillée bleue - Cromado con cinta esmaltada azul

- 8/338 Zahlen - Figures - Chiffres - Cifras
- 8/339 Striche - Strokes - Barres - Rayas

**Silberblatt** - Silver dial - Cadran argenté  
Esfera plateada

1 Tag Weckerwerk No. 231 L - 1 day alarm movement No. 231 L  
30 heures réveil mouvement No. 231 L - Despertador, 30 horas cuerda, No. 231 L



**Junghans „Silent“, der lautlos gehende Wecker**

The alarm without tick-tack - Le réveil sans tic-tac - El despertador sin tique-taque



12 cm = 4 1/2 inches

**8/348 Metallgehäuse rothraun**  
Claret coloured metal case  
Boîte métal brun-rouge  
Caja de metal rojo oscuro



10,5 cm = 4 1/8 inches

**Metallgehäuse verchromt mit blau emailiertem Band** - Chromium plated metal case with blue enameled centre-band - Boîte métal chromé avec bande émaillée bleue - Caja de metal cromada con cinta esmaltada azul

**8/349 Zahlen** - Figures - Chiffres - Cifras

**8/350 Striche** - Strokes - Barres - Rayas

**Metallgehäuse verchromt mit schwarz emailiertem Band** - Chromium plated metal case with black enameled centre-band - Boîte métal chromé avec bande émaillée noire - Caja de metal cromada con cinta esmaltada negra

**8/351 Striche** - Strokes - Barres - Rayas

**Silberblatt** - Silver dial - Cadran argenté  
Esfera plateada



11 cm = 4 1/4 inches

**Verchromt mit blau emailiertem Band** - Chromium plated with blue enameled centre-band  
Chromé avec bande émaillée bleue - Cromado con cinta esmaltada azul

**8/352 Striche** - Strokes - Barres - Rayas

**Silberblatt** - Silver dial - Cadran argenté - Esfera plateada

**1 Tag Weckerwerk No. 231 G, Schlag auf Rückwand** - 1 day alarm movement No. 231 G, strike on back  
30 heures réveil mouvement No. 231 G, sonnerie sur fond - Despertador, 30 horas cuerda, No. 231 G, tocando en el respaldo

**Verchromt mit schwarz emailiertem Band** - Chromium plated with black enameled centre-band - Chromé avec bande émaillée noire  
Cromado con cinta esmaltada negra

**8/353 Zahlen** - Figures - Chiffres - Cifras



**Junghans „Silent“, der lautlos gehende Wecker**

The alarm without tick-tack - Le réveil sans tic-tac - El despertador sin tique-taque

Junghans „Silent“

Junghans „Silent“



12,5 cm = 4 7/8 inches

**8/301 Metallgehäuse rothraun** - Claret coloured metal case - Boîte métal brun-rouge - Caja de metal rojo oscuro

**Weißes Kartonblatt** - White cardboard dial  
Cadran carton blanc - Esfera blanca de cartón



12,5 cm = 4 7/8 inches

**8/302 Metallgehäuse verchromt mit blau emailiertem Band** - Chromium plated metal case with blue enameled centre-band - Boîte métal chromé avec bande émaillée bleue - Caja de metal cromada con cinta esmaltada azul

**Silberblatt** - Silver dial - Cadran argenté  
Esfera plateada

**1 Tag Weckerwerk No. 10 G, Schlag auf Glocke innen** - 1 day alarm movement No. 10 G, back bell  
30 heures réveil mouvement No. 10 G, timbre fond - Despertador, 30 horas cuerda No. 10 G, campana en el respaldo

**Solange Wecker gebraucht werden,**

solange wird auch ihr Ticken störend empfunden. Mit seinem harten Rhythmus zerreit es die Stille der Nacht und raubt vielen Menschen den heifersehnten, krftigenden Schlaf.

Schon lange wird daher an dem Problem des lautlos gehenden Weckers gearbeitet, doch ohne den rechten Erfolg, bis es endlich Junghans gelang, diese restlos befriedigende Konstruktion des lautlos tickenden Weckers zu schaffen.

Schon in einer kleinen Entfernung vom Ohr des Schlafers kann der Gang des Junghans „Silent“ auch in der Stille der Nacht nicht mehr gehrt werden.

Junghans „Silent“, dieser sympathische Wecker, wird allen Menschen willkommen sein, die das Ticken bisher hufig am Einschlafen hinderte.

Wie ein stummer Diener wird er auch Ihren Schlaf bewachen und zur gewnschten Zeit, pntklicher als der pntklichste Diener, mit seinem hellen Weckruf beenden.

**Aussi longtemps que le réveil restera un objet indispensable,**

aussi longtemps son tic-tac nous drangera. Il dchire par son dur rythme le silence de la nuit et te à beaucoup de personnes le sommeil reconfortant et attendu avec tant d'ardeur.

C'est donc depuis bien longtemps que l'on cherche à solutionner le problème d'un réveil à marche silencieuse, mais sans vrai succès, jusqu'à ce que Junghans a réussi à créer cette construction satisfaisante sous tous les rapports.

À une distance de 15 cm seulement de l'oreille du dormeur, la marche de Junghans „Silent“ (sans tic-tac) n'est déjà plus perceptible, même au milieu du silence de la nuit.

Junghans „Silent“, ce réveil sympathique, sera le bienvenu de toutes les personnes empêchées parfois de s'endormir à cause du tic-tac.

Aussi veillera-t-il, tel un serviteur muet, sur votre sommeil pour lui dicter, avec plus de ponctualité que le serviteur le plus ponctuel, la fin à l'heure fixée d'avance, par sa sonnerie claire.

**Ever since Alarms have been in use,**

their ticking has had an annoying effect. Their harsh rhythm severs the quietness of the night and deprives many people of their coveted, refreshing sleep.

The many efforts made in the past to create a noiseless alarm were only partially successful until Junghans, at last, succeeded in solving this problem entirely.

Placed only four inches from the ear of the sleeper, the action of Junghans „Silent“ is imperceptible, even in the quietness of night.

Junghans „Silent“ this appealing alarm, will be welcomed by all those whom the ticking of the alarm hitherto frequently prevented from dropping off to sleep. It will also guard your sleep like a silent servant and will call you by its clear ringing at the desired time, more punctually than the most punctual servant.

**En tanto que el despertador esté en uso,**

en tanto su tique-taque quedará perturbativo. Con su duro ritmo rompe el silencio de la noche, robando a muchísimas personas el sueño reconfortativo y esperado ansiosamente.

Desde hace mucho tiempo se está buscando pues la solución del problema de un despertador à marcha silenciosa, sin lograrlo, sin embargo, hasta que Junghans recientemente ha tenido la suerte de resolverlo por la actual construcción, satisfactoria bajo todos los conceptos.

A una distancia de no más de 15 cm de la oreja del durmiente, la marcha del Junghans „Silent“ (sin tique-taque) ya no se percibe en medio de la noche silenciosa. Junghans „Silent“ será el bienvenido de cuantas personas que frecuentemente hayan sido impedidas de dormirse por motivo del tique-taque.

Tal un servidor mudo velará el Junghans „Silent“ sobre su sueño, para terminarlo, con mayor puntualidad que el más puntual servidor, en la hora precisa fijada, por su sonería clara.



Zumba



18 cm = 7 inches

56/25

Der Elefant bewegt den Kopf - Elephant moving its head  
L'éléphant remuant la tête  
El elefante mueve la cabeza

Fußball



18 cm = 7 inches

56/26

Der Fußballspieler stößt den Ball - Footballplayer  
kicking the ball - Le joueur de foot-ball envoyant  
le ballon - El jugador chuta al balón

Sulu



16 cm = 6 1/4 inches

56/27

Der Neger bewegt die Augen - Negro moving the eyes  
Nègre tournant les yeux - El negro mueve los ojos

Jazzo



18 cm = 7 inches

56/41

Der Neger bewegt die Augen und den Arm  
Negro moving eyes and one arm  
Nègre tournant les yeux et remuant le bras  
El negro mueve los ojos y toca la guitarra

1 Tag Wecker, kleines Werk - 1 day alarm, small movement

30 heures réveil, petit mouvement - 30 horas despertador, máquina pequeña

Metallgehäuse vernickelt - Nickelled metal case - Boite métal nickelé - Caja de metal niquelado



Joker I



18 cm = 7 inches

- 8/9 1 Tag Wecker - 1 day alarm - 30 heures réveil  
30 horas despertador
- 8/15 1 Tag Schlagwerk - 1 day strike - 30 heures sonnerie - 30 horas sonería
- 8/16 1 Tag Schlagwerk und Wecker - 1 day strike and alarm - 30 heures sonnerie et réveil - 30 horas despertador y sonería

- 8/17 1 Tag Musikwecker, 1 Arie - 1 day musical alarm, 1 air - 30 heures réveil musique, 1 air - 30 horas despertador de música, 1 pieza
- 8/18 1 Tag Musikwecker, 2 Arien - 1 day musical alarm, 2 airs - 30 heures réveil musique, 2 airs - 30 horas despertador de música, 2 piezas
- 8/19 1 Tag Musikschlagwerk, 1 Arie - 1 day musical strike, 1 air - 30 heures sonnerie musique, 1 air 30 horas sonería á música, 1 pieza

Joker II



18 cm = 7 inches

- 8/20 1 Tag Wecker - 1 day alarm - 30 heures réveil  
30 horas despertador
- 8/21 1 Tag Schlagwerk - 1 day strike - 30 heures sonnerie - 30 horas sonería
- 8/22 1 Tag Schlagwerk und Wecker - 1 day strike and alarm - 30 heures sonnerie et réveil - 30 horas despertador y sonería
- 8/23 1 Tag Musikwecker, 1 Arie - 1 day musical alarm, 1 air - 30 heures réveil musique, 1 air - 30 horas despertador de música, 1 pieza
- 8/24 1 Tag Musikwecker, 2 Arien - 1 day musical alarm, 2 airs - 30 heures réveil musique, 2 airs - 30 horas despertador de música, 2 piezas
- 8/25 1 Tag Musikschlagwerk, 1 Arie - 1 day musical strike, 1 air - 30 heures sonnerie musique, 1 air 30 horas sonería á música, 1 pieza

Joker III

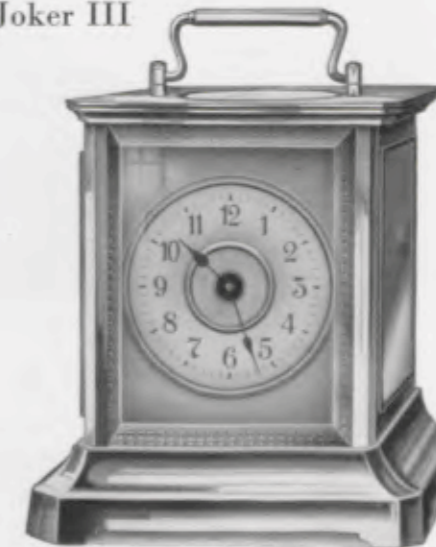

18 cm = 7 inches

- 8/35 1 Tag Wecker - 1 day alarm - 30 heures réveil  
30 horas despertador
- 8/36 1 Tag Schlagwerk - 1 day strike - 30 heures sonnerie - 30 horas sonería
- 8/37 1 Tag Schlagwerk und Wecker - 1 day strike and alarm - 30 heures sonnerie et réveil - 30 horas despertador y sonería
- 8/38 1 Tag Musikwecker, 1 Arie - 1 day musical alarm, 1 air - 30 heures réveil musique, 1 air - 30 horas despertador de música, 1 pieza
- 8/39 1 Tag Musikwecker, 2 Arien - 1 day musical alarm, 2 airs - 30 heures réveil musique, 2 airs - 30 horas despertador de música, 2 piezas
- 8/40 1 Tag Musikschlagwerk, 1 Arie - 1 day musical strike, 1 air - 30 heures sonnerie musique, 1 air 30 horas sonería á música, 1 pieza

Stahlgehäuse - Steel cases - Boîtes acier - Cajas de acero





GRUPPE 9

*Wecker in Holzgehäusen*

Alarm clocks in wooden cases – Réveils en boîtes bois  
Despertadores en cajas de madera



12 x 22 cm – 4 7/8 x 8 3/4 inches

9/133

Eiche – Oak – Chêne – Roble

Kartonblatt – Cardboard dial – Cadran carton – Esfera de cartón



12 x 22 cm – 4 7/8 x 8 3/4 inches

9/134

Kaukasisch Nußbaum poliert – Polished Caucasian walnut  
Noyer Caucasiens poli – Nogal Caúcaseo pulido

Chromlunette, Silberblatt – Chromium plated bezel, silver dial  
Lunette chromée, cadran argenté – Bisel cromado, esfera plateada

1 Tag Wecker mit oder ohne RZ – 1 day alarm – 30 heures réveil – 30 horas cuerda, despertador

9/133: In allen Eichenfarben lieferbar – Can be had in all oak colours  
Livrables en toutes teintes de chêne – Se hacen en todos los colores de roble



GRUPPE 10

*Schreibtischuhren*

Writing table clocks – Pendulettes de bureau – Relojes para escritorio



13,5 x 18,5 cm – 5 1/4 x 7 1/4 inches

10/62 Kaukasisch Nußbaum poliert – Polished Caucasian walnut – Noyer Caucasiens poli – Nogal Caúcaseo pulido

10/66 Kaukasisch Nußbaum matt – Mat Caucasian walnut – Noyer Caucasiens mat  
Nogal Caúcaseo mate  
Silberblatt – Silver dial – Cadran argenté – Esfera plateada



12 x 30 cm – 4 3/4 x 11 3/4 inches

10/67 Eiche mit Nußbaum poliert – Oak with polished walnut  
Chêne avec noyer poli – Roble con nogal pulido  
Silberzahlenreif – Silvered figure-circle – Cercle à chiffres argenté  
Cercos de cifras plateado



12 x 30 cm – 4 3/4 x 11 3/4 inches

10/68 Kaukasisch Nußbaum poliert – Polished Caucasian walnut  
Noyer Caucasiens poli – Nogal Caúcaseo pulido  
Silberzahlenreif – Silvered figure-circle – Cercle à chiffres argenté  
Cercos de cifras plateado

Chromlunette – Chromium plated bezel – Lunette chromée – Bisel cromado

8 Tag Ankergehwerk – 8 day lever time movement  
8 jours simple, échappement à ancre – Máquina, 8 días cuerda, escape á áncora



12 x 25 cm = 4 3/4 x 9 3/4 inches

10/69 Eiche mit Nußbaum poliert - Oak with polished walnut  
Chêne avec noyer poli - Roble con nogal pulido

Silberzahlenreif - Silvered figure-circle  
Cercle à chiffres argenté - Cerco de cifras plateado



12 x 25 cm = 4 3/4 x 9 3/4 inches

10/70 Kaukasisch Nußbaum poliert - Polished Caucasian walnut  
Noyer Caucasiens poli - Nogal Caúcaso pulido

Silberzahlenreif - Silvered figure-circle  
Cercle à chiffres argenté - Cerco de cifras plateado



12 x 22 cm = 4 3/4 x 8 3/4 inches

10/71 Kaukasisch Nußbaum poliert - Polished Caucasian walnut  
Noyer Caucasiens poli - Nogal Caúcaso pulido

Silberblatt - Silver dial - Cadran argenté - Esfera plateada

Chromlünette - Chromium plated bezel - Lunette chromée - Bisel cromado

8 Tag Ankergehwerk - 8 day lever time movement  
8 jours simple, échappement à ancre - Máquina, 8 días cuerda, escape á áncora



GRUPPE 12

Schiffsuhren

Ship Clocks - Horloges marine - Relojos Marina

Marine



Gehäuse-Durchmesser - Diameter of case  
Diamètre de la cage - Diámetro de la caja  
12/1: 16,5 cm = 6 1/2 inches  
12/2, 12/3: 18,5 cm = 7 1/4 inches  
12/4, 12/39, 12/40: 25 cm = 10 inches  
12/41, 12/42: 29 cm = 11 1/2 inches

Zifferblatt-Durchmesser - Diameter of dial  
Diamètre du cadran - Diámetro de la esfera  
12/1: 10,5 cm = 4 inches  
12/2, 12/3: 11,5 cm = 4 1/2 inches  
12/4, 12/39, 12/40: 16,5 cm = 6 inches  
12/41, 12/42: 20,5 = 8 inches

12/1, 12/2, 12/4

1 Tag Gehwerk  
1 day time  
30 heures simple  
30 horas movimiento solo

12/3

1 Tag Schlagwerk  
1 day strike  
30 heures sonnerie  
30 horas sonería

12/39, 12/41

8 Tag Gehwerk  
8 day time  
8 jours simple  
8 días movimiento solo

12/40, 12/42

8 Tag Schlagwerk  
8 day strike  
8 jours sonnerie  
8 días sonería

Nußbaum - Walnut - Noyer - Nogal

Lackblatt - Lacquered dial - Cadran verni - Esfera esmaltada

World I

Flotte



19,5 cm = 7 1/2 inches

13 cm = 5 inches

Gehäuse-Durchmesser - Diameter of case  
Diamètre de la cage - Diámetro de la caja

Zifferblatt-Durchmesser - Diameter of dial  
Diamètre du cadran - Diámetro de la esfera

34 cm = 13 1/2 inches

25 cm = 10 inches

Messinggehäuse - Brass case - Boîte laiton  
Caja de latón

12/10 Vernickelt - Nickelled - Nickelé  
Niquelado

Silberblatt - Silver dial - Cadran argenté - Esfera plateada

12/62 Mahagonifarbig - Mahogany finish - Teinte acajou  
Color caoba

Lackblatt - Lacquered dial - Cadran verni - Esfera esmaltada

8 Tag Präzisions-Gehwerk, Echappement mit 4 Steinen - 8 day precision time movement, escapement with 4 jewels  
Mouvement de précision, 8 jours simple, échappement avec 4 rubis - Máquina de precisión, 8 días cuerda, escape á áncora con 4 rubis



GRUPPE 14

Autouhren

Motor car clocks – Montres pour auto – Relojes para automovil

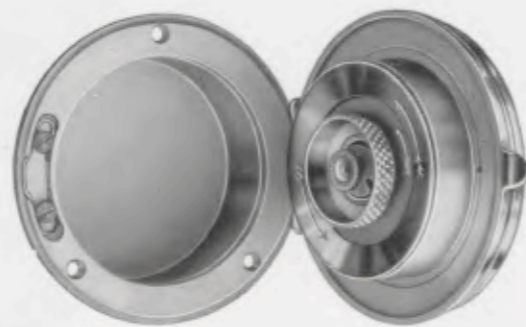
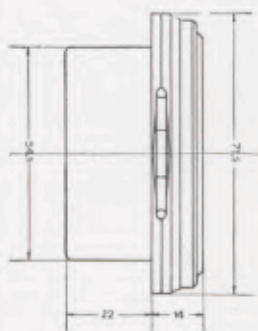

7 cm = 2 3/4 inches

**14/23** 8 Tag Taschenuhr-Präzisionswerk No. J 30, 7steinig, Metallblatt weiß oder schwarz  
 8 day precision watch movement No. J 30, 7 jewels, white or black metal dial  
 Mouvement de montre de précision No. J 30, 7 rubis, cadran métal blanc ou noir  
 Máquina de reloj de bolsillo de precisión No. J 30, 8 días cuerda, 7 rubis, esfera de metal blanca ó negra  
 Messinggehäuse vernickelt – Brass case nickelled – Boîte laiton nickelé – Caja de latón niquelado

Autouhr mit Scharnier

Motor car clock with hinge – Montre pour auto avec charnière – Reloj para automovil con charnela



Durchmesser 65 mm

Diameter 65 mm – Diamètre 65 mm – Diámetro 65 mm

14/121

Durchmesser 80 mm

Diameter 80 mm – Diamètre 80 mm – Diámetro 80 mm

14/122

**8 Tag Ankergewerk No. J 44 ohne Steine** – 8 day lever time movement No. J 44 without jewels  
 Mouvement No. J 44, 8 jours simple, échappement à ancre, sans rubis  
 Máquina No. J. 44, 8 días cuerda, escape á áncora, sin rubis

Messinggehäuse vernickelt – Brass case nickelled – Boîte laiton nickelé – Caja de latón niquelado

Metallblatt weiß oder schwarz – White or black metal dial  
 Cadran métal blanc ou noir – Esfera de metal blanca ó negra

Mit oder ohne leuchtende Radiumziffern (RZ) – With or without luminous figures (RZ)  
 Avec ou sans chiffres lumineux au Radium (RZ) – Con ó sin cifras luminosas Radium (RZ)



25,5 x 52 cm = 10 x 20 1/2 inches

Eiche – Oak – Chêne – Roble

**17/542** Rundgong – Gong – Gong rond – Gong redondo  
**17/542 B** Bachgong – Gong „Bim Bam“  
**17/542 W** 1/4 Westminsterschlag – 1/4 Westminster chime – 1/4 Carillon Westminster

Zifferblatt – Dial – Cadran – Esfera 18 cm = 7 inches



26 x 52 cm = 10 1/4 x 20 1/2 inches

Eiche – Oak – Chêne – Roble

**17/648** Rundgong – Gong – Gong rond – Gong redondo  
**17/648 B** Bachgong – Gong „Bim Bam“  
**17/648 W** 1/4 Westminsterschlag – 1/4 Westminster chime – 1/4 Carillon Westminster

Chromlunette, Zahlenreif versilbert  
 Chromium plated bezel, silvered figure-circle  
 Lunette chromée, cercle à chiffres argenté  
 Bisel cromado, cerco de cifras plateado

18 cm = 7 inches

In allen Eichenfarben lieferbar – Can be had in all oak colours  
 Livrables en toutes teintes de chêne – Las cajas de roble se hacen en todos los colores



27 x 59 cm = 10 3/4 x 23 1/4 inches

Eiche - Oak - Chêne - Roble

17/544 Rundgong - Gong - Gong rond - Gong redondo 17/544 B Bachgong - Gong „Bim Bam“  
17/544 W 3/4 Westminsterschlag - 3/4 Westminster chime - 3/4 Carillon Westminster



27 x 56 cm = 10 3/4 x 22 inches

Eiche - Oak - Chêne - Roble

17/545 Rundgong - Gong - Gong rond - Gong redondo 17/545 B Bachgong - Gong „Bim Bam“  
17/545 W 3/4 Westminsterschlag - 3/4 Westminster chime - 3/4 Carillon Westminster



28,5 x 50,5 cm = 11 1/4 x 19 3/4 inches

Eiche - Oak - Chêne - Roble

17/546 Rundgong - Gong - Gong rond - Gong redondo 17/546 B Bachgong - Gong „Bim Bam“  
17/546 W 3/4 Westminsterschlag - 3/4 Westminster chime - 3/4 Carillon Westminster  
Zifferblatt - Dial - Cadran - Esfera 18 cm = 7 inches

In allen Eichenfarben lieferbar - Can be had in all oak colours

Livrables en toutes teintes de chêne - Las cajas de roble se hacen en todos los colores



27 x 54 cm = 10 1/2 x 21 1/4 inches

Eiche - Oak - Chêne - Roble

17/569 Rundgong - Gong - Gong rond - Gong redondo  
17/569 B Bachgong - Gong „Bim Bam“  
17/569 W 3/4 Westminsterschlag - 3/4 Westminster chime - 3/4 Carillon Westminster

Zifferblatt - Dial - Cadran - Esfera 15 x 18,5 cm = 6 x 7 1/4 inches



31 x 60 cm = 12 1/4 x 26 3/4 inches

Eiche - Oak - Chêne - Roble

17/547 Rundgong - Gong - Gong rond - Gong redondo  
17/547 B Bachgong - Gong „Bim Bam“  
17/547 W 3/4 Westminsterschlag - 3/4 Westminster chime - 3/4 Carillon Westminster

Zifferblatt - Dial - Cadran - Esfera 20 cm = 8 inches

In allen Eichenfarben lieferbar - Can be had in all oak colours  
Livrables en toutes teintes de chêne - Las cajas de roble se hacen en todos los colores



21 x 41 cm = 8 1/4 x 16 1/4 inches

- 17/528 Nußbaum poliert - Polished walnut - Noyer poli - Nogal pulido  
 17/646 Schwedisch Birke - Swedish birch - Bouleau suédois - Alamo sueco

Rundgong - Gong - Gong rond - Gong redondo  
 Bachgong - Gong „Bim Bam“

1/4 Westminsterschlag - 1/4 Westminster chime - 1/4 Carillon Westminster

Zifferblatt - Dial - Cadran - Esfera 15 cm = 6 inches



25 x 32,5 cm = 9 7/8 x 20 1/4 inches

- 17/548 Nußbaum poliert - Polished walnut - Noyer poli - Nogal pulido  
 17/649 Mahagoni - Mahogany - Acajou - Caoba

Chromlünette, Silberzahlenreif - Chromium plated bezel, silvered figure-circle  
 Lunette chromée, cercle à chiffres argenté - Bisel cromado, cerco de cifras plateado 18 cm = 7 inches

Rundgong - Gong - Gong rond - Gong redondo  
 Bachgong - Gong „Bim Bam“

1/4 Westminsterschlag - 1/4 Westminster chime - 1/4 Carillon Westminster



27 x 59 cm = 10 5/8 x 23 1/4 inches

Nußbaum poliert - Polished walnut - Noyer poli - Nogal pulido

- 17/549 Rundgong - Gong - Gong rond - Gong redondo  
 17/549 B Bachgong - Gong „Bim Bam“  
 17/549 W 1/4 Westminsterschlag - 1/4 Westminster chime - 1/4 Carillon Westminster

Chromlünette, Silberzahlenreif - Chromium plated bezel, silvered figure-circle  
 Lunette chromée, cercle à chiffres argenté - Bisel cromado, cerco de cifras plateado  
 18 cm = 7 inches



25,5 x 55 cm = 10 x 21 1/4 inches

Mahagoni - Mahogany - Acajou - Caoba

- 17/459 Rundgong - Gong - Gong rond - Gong redondo  
 17/459 B Bachgong - Gong „Bim Bam“  
 17/459 W 1/4 Westminsterschlag - 1/4 Westminster chime - 1/4 Carillon Westminster

Goldblatt - Gilt dial - Cadran doré - Esfera dorada 15 x 18,5 cm = 6 x 7 1/4 inches

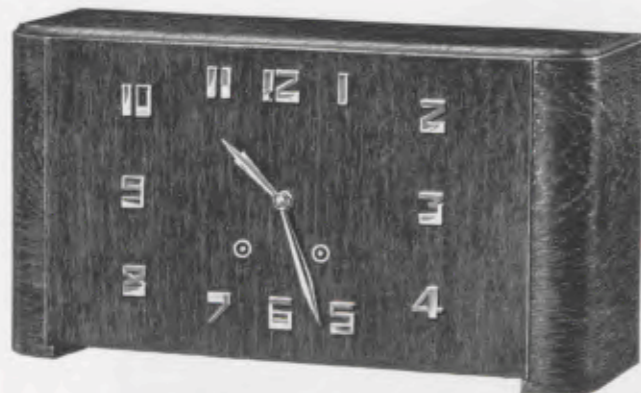

21 x 33 cm = 8 1/4 x 13 inches

Eiche - Oak - Chêne - Roble

**17/611** Matt vergoldete Zahlen und Zeiger  
Mat gilt figures and hands  
Chiffres et aiguilles dorés mat  
Cifras y agujas doradas mate

**17/612** Verchromte Zahlen und Zeiger  
Chromium plated figures and hands  
Chiffres et aiguilles chromés  
Cifras y agujas cromadas



21 x 33 cm = 8 1/4 x 13 inches

**17/613** Eiche - Oak - Chêne - Roble

Chromlunette, Zahlenreif versilbert  
Chromium plated bezel, silvered figure-circle  
Lunette chromée, cercle à chiffres argenté  
Bisel cromado, cerco de cifras plateado

16 cm = 6 1/4 inches

Rundgong - Gong - Gong rond - Gong redondo

Bachgong - Gong „Bim Bam“ \* 1/4 Westminsterschlag - 1/4 Westminster chime - 1/4 Carillon Westminster



21 x 33 cm = 8 1/4 x 13 inches

**17/614** Eiche mit polierter Nußbaumfront  
Oak with polished walnut front  
Chêne avec front noyer poli  
Roble con frente nogal pulido

Matt versilberte Zahlen und Zeiger  
Mat-silvered figures and hands  
Chiffres et aiguilles argentés, mat  
Cifras y agujas plateadas, mate

Rundgong - Gong - Gong rond - Gong redondo

Bachgong - Gong „Bim Bam“



21 x 33 cm = 8 1/4 x 13 inches

**17/615** Eiche mit polierter Nußbaumfront  
Oak with polished walnut front  
Chêne avec front noyer poli  
Roble con frente nogal pulido

Chromlunette, Zahlenreif versilbert  
Chromium plated bezel, silvered figure-circle  
Lunette chromée, cercle à chiffres argenté  
Bisel cromado, cerco de cifras plateado  
16 cm = 6 1/4 inches

Rundgong - Gong - Gong rond - Gong redondo  
Bachgong - Gong „Bim Bam“



21 x 33 cm = 8 1/4 x 13 inches

**17/644** Eiche mit polierter Nußbaumfront  
Oak with polished walnut front  
Chêne avec front noyer poli  
Roble con frente nogal pulido

Chromlunette, Zahlenreif versilbert  
Chromium plated bezel, silvered figure-circle  
Lunette chromée, cercle à chiffres argenté  
Bisel cromado, cerco de cifras plateado  
15 x 15 cm = 6 x 6 inches



20 x 33 cm = 8 x 13 inches

**17/635** Kaukasisch Nußbaum poliert  
Polished Caucasian walnut  
Noyer Caucasiens poli  
Nogal Caucaso pulido

Matt versilberte Zahlen und Zeiger  
Mat-silvered figures and hands  
Chiffres et aiguilles argentés, mat  
Cifras y agujas plateadas, mate

Rundgong - Gong - Gong rond - Gong redondo  
Bachgong - Gong „Bim Bam“

1/4 Westminsterschlag - 1/4 Westminster chime  
1/4 Carillon Westminster



20 x 33 cm = 8 x 13 inches

**17/636** Kaukasisch Nußbaum poliert  
Polished Caucasian walnut  
Noyer Caucasien poli  
Nogal Caúcaso pulido

Chromlunette, Zahlenreif versilbert  
Chromium plated bezel, silvered figure-circle

Lunette chromée, cercle à chiffres argenté  
Bisel cromado, cerco de cifras plateado  
17 cm = 6<sup>3</sup>/<sub>4</sub> inches

Rundgong - Gong - Gong rond - Gong redondo

Bachgong - Gong „Bim Bam“

<sup>1</sup>/<sub>4</sub> Westminsterschlag - <sup>1</sup>/<sub>4</sub> Westminster chime - <sup>1</sup>/<sub>4</sub> Carillon Westminster

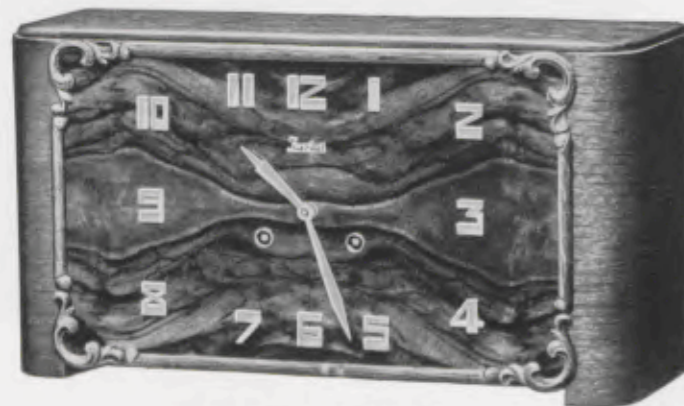

21 x 39 cm = 8<sup>1</sup>/<sub>2</sub> x 15<sup>3</sup>/<sub>8</sub> inches

**17/643** Eiche mit kaukasisch Nußbaumfront, poliert  
Oak with polished Caucasian walnut front  
Chêne avec front noyer Caucasien poli  
Roble con frente nogal Caúcaso pulido

Matt versilberte Zahlen und Zeiger  
Mat-silvered figures and hands  
Chiffres et aiguilles argentés, mat  
Cifras y agujas plateadas, mate

Rundgong - Gong - Gong rond - Gong redondo

Bachgong - Gong „Bim Bam“



21 x 40 cm = 8<sup>1</sup>/<sub>2</sub> x 15<sup>3</sup>/<sub>8</sub> inches

**17/632** Kaukasisch Nußbaum poliert  
Polished Caucasian walnut  
Noyer Caucasien poli  
Nogal Caúcaso pulido

Matt versilberte Zahlen und Zeiger  
Mat-silvered figures and hands  
Chiffres et aiguilles argentés, mat  
Cifras y agujas plateadas, mate

Rundgong - Gong - Gong rond - Gong redondo

Bachgong - Gong „Bim Bam“

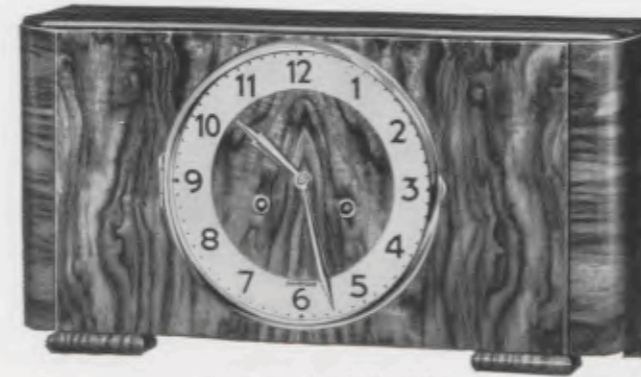

21 x 40 cm = 8<sup>1</sup>/<sub>2</sub> x 15<sup>3</sup>/<sub>8</sub> inches

**17/633** Kaukasisch Nußbaum poliert  
Polished Caucasian walnut  
Noyer Caucasien poli  
Nogal Caúcaso pulido

Chromlunette, Zahlenreif versilbert  
Chromium plated bezel, silvered figure-circle

Lunette chromée, cercle à chiffres argenté  
Bisel cromado, cerco de cifras plateado  
17 cm = 6<sup>3</sup>/<sub>4</sub> inches

Rundgong - Gong - Gong rond - Gong redondo

Bachgong - Gong „Bim Bam“



21,5 x 30 cm = 8<sup>1</sup>/<sub>2</sub> x 11<sup>1</sup>/<sub>8</sub> inches

**17/554** Kaukasisch Nußbaum matt  
Mat Caucasian walnut  
Noyer Caucasien mat  
Nogal Caúcaso mate

Chromlunette, Zahlenreif versilbert  
Chromium plated bezel, silvered figure-circle

Lunette chromée, cercle à chiffres argenté  
Bisel cromado, cerco de cifras plateado  
17 cm = 6<sup>3</sup>/<sub>4</sub> inches

Rundgong - Gong - Gong rond - Gong redondo

Bachgong - Gong „Bim Bam“



21 x 42 cm = 8<sup>1</sup>/<sub>2</sub> x 16<sup>1</sup>/<sub>8</sub> inches

**17/631** Kaukasisch Nußbaum poliert  
Polished Caucasian walnut  
Noyer Caucasien poli  
Nogal Caúcaso pulido

**17/640** Mahagoni poliert  
Polished mahogany  
Acajou poli  
Caoba pulido

Chromlunette, Zahlenreif versilbert  
Chromium plated bezel, silvered figure-circle

Lunette chromée, cercle à chiffres argenté  
Bisel cromado, cerco de cifras plateado  
18 cm = 7 inches

Rundgong - Gong - Gong rond - Gong redondo

Bachgong - Gong „Bim Bam“

<sup>1</sup>/<sub>4</sub> Westminsterschlag - <sup>1</sup>/<sub>4</sub> Westminster chime - <sup>1</sup>/<sub>4</sub> Carillon Westminster



21 x 40 cm = 8 1/4 x 15 3/4 inches

**17/656** Kaukasisch Nußbaum poliert  
Polished Caucasian walnut  
Noyer Caucasien poli  
Nogal Caúcaseo pulido

**Chromlunette, Zahlenreif und Zeiger versilbert**

Chromium plated bezel, silvered figure-circle and hands

Lunette chromée, aiguilles et cercle à chiffres argentés

Bisel cromado, cerco de cifras y agujas plateados

17 cm = 6 3/4 inches

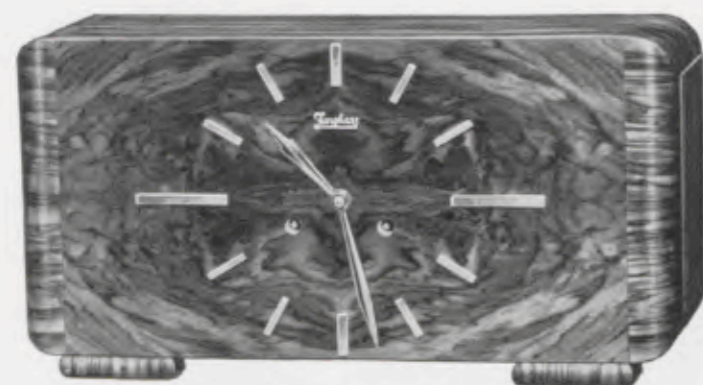

21 x 40 cm = 8 1/4 x 15 3/4 inches

**17/652** Matt versilberte Zahlen und Zeiger  
Mat-silvered figures and hands  
Chiffres et aiguilles argentés, mat  
Cifras y agujas plateadas, mate

**17/653** Matt versilberte Striche und Zeiger  
Mat-silvered strokes and hands  
Barres et aiguilles argentées, mat  
Rayas y agujas plateadas, mate

**Kaukasisch Nußbaum poliert**  
Polished Caucasian walnut  
Noyer Caucasien poli  
Nogal Caúcaseo pulido

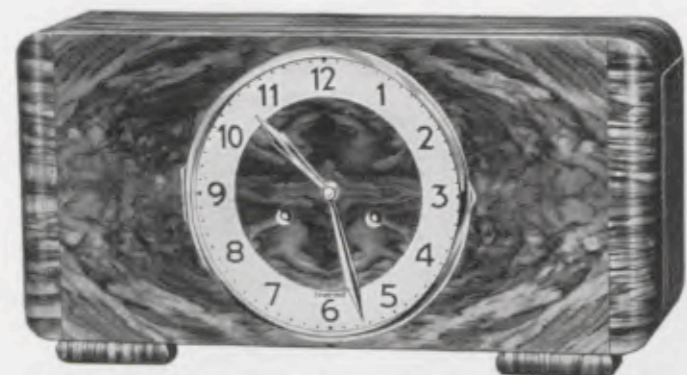

21 x 40 cm = 8 1/4 x 15 3/4 inches

**17/654** Kaukasisch Nußbaum poliert  
Polished Caucasian walnut  
Noyer Caucasien poli  
Nogal Caúcaseo pulido

**Chromlunette, Zahlenreif versilbert**  
Chromium plated bezel, silvered figure-circle

Lunette chromée, cercle à chiffres argenté

Bisel cromado, cerco de cifras plateado

18 cm = 7 inches

Rundgong - Gong - Gong rond - Gong redondo \* Bachgong - Gong „Bim Bam“

3/4 Westminsterschlag - 3/4 Westminster chime - 3/4 Carillon Westminster

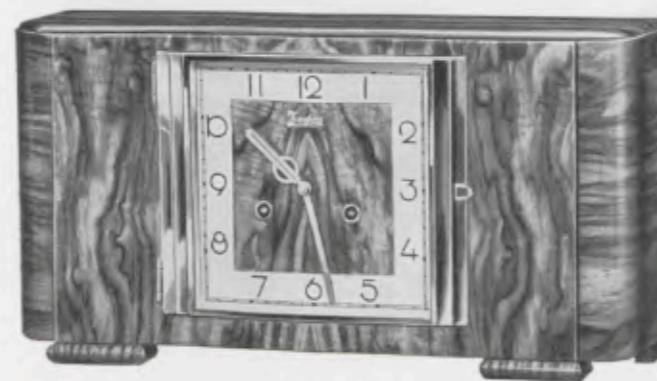

21 x 40 cm = 8 1/4 x 15 3/4 inches

**17/634** Kaukasisch Nußbaum poliert  
Polished Caucasian walnut  
Noyer Caucasien poli  
Nogal Caúcaseo pulido

**Chromlunette, Zahlenreif versilbert**  
Chromium plated bezel, silvered figure-circle

Lunette chromée, cercle à chiffres argenté

Bisel cromado, cerco de cifras plateado

16 x 19,5 cm = 6 1/4 x 7 3/4 inches



21,5 x 44 cm = 8 1/2 x 17 3/4 inches

**17/577** Kaukasisch Nußbaum poliert  
Polished Caucasian walnut  
Noyer Caucasien poli  
Nogal Caúcaseo pulido

**Chromlunette, Zahlenreif versilbert**  
Chromium plated bezel, silvered figure-circle

Lunette chromée, cercle à chiffres argenté

Bisel cromado, cerco de cifras plateado

18 cm = 7 inches

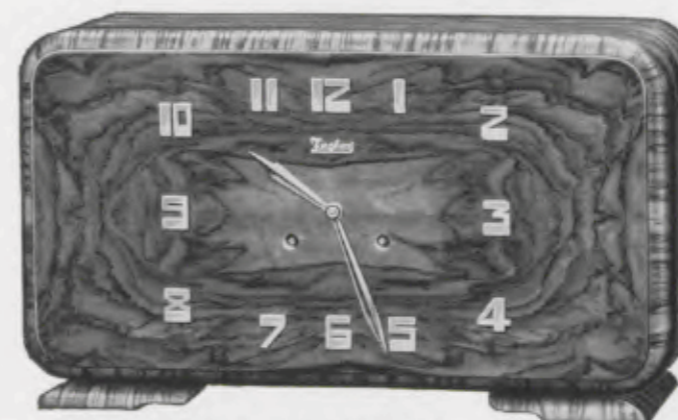

23 x 40 cm = 9 x 15 3/4 inches

**17/650** Matt versilberte Zahlen und Zeiger  
Mat-silvered figures and hands  
Chiffres et aiguilles argentés, mat  
Cifras y agujas plateadas, mate

**17/651** Matt versilberte Striche und Zeiger  
Mat-silvered strokes and hands  
Barres et aiguilles argentées, mat  
Rayas y agujas plateadas, mate

**Kaukasisch Nußbaum poliert**  
Polished Caucasian walnut  
Noyer Caucasien poli  
Nogal Caúcaseo pulido

Rundgong - Gong - Gong rond - Gong redondo \* Bachgong - Gong „Bim Bam“

3/4 Westminsterschlag - 3/4 Westminster chime - 3/4 Carillon Westminster





21 x 42 cm = 8 1/4 x 16 1/2 inches

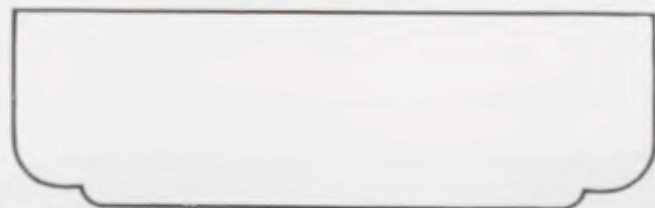

21 x 42 cm = 8 1/4 x 16 1/2 inches



21 x 42 cm = 8 1/4 x 16 1/2 inches

**17/638** Kaukasisch Nußbaum poliert  
Polished Caucasian walnut  
Noyer Caucasiens poli  
Nogal Caúcaso pulido

**Chromlünette, Zahlenreif versilbert**  
Chromium plated bezel, silvered figure-circle  
Lunette chromée, cercle à chiffres argenté  
Bisel cromado, cerco de cifras plateado  
18 cm = 7 inches

**Rundgong - Gong - Gong rond - Gong redondo**

**Bachgong - Gong „Bim Bam“**

3/4 Westminsterschlag - 3/4 Westminster chime - 3/4 Carillon Westminster

**17/639** Kaukasisch Nußbaum poliert  
Polished Caucasian walnut  
Noyer Caucasiens poli  
Nogal Caúcaso pulido

**Chromlünette, Zahlenreif und Zeiger versilbert**  
Chromium plated bezel, silvered figure-circle and hands  
Lunette chromée, aiguilles et cercle à chiffres argentés  
Bisel cromado, cerco de cifras y agujas plateados  
18 cm = 7 inches

**Rundgong - Gong - Gong rond - Gong redondo**

**Bachgong - Gong „Bim Bam“**

**17/641** Kaukasisch Nußbaum poliert  
Polished Caucasian walnut  
Noyer Caucasiens poli  
Nogal Caúcaso pulido

**Chromlünette, Zahlenreif versilbert**  
Chromium plated bezel, silvered figure-circle  
Lunette chromée, cercle à chiffres argenté  
Bisel cromado, cerco de cifras plateado  
18 cm = 7 inches

**Rundgong - Gong - Gong rond - Gong redondo**

**Bachgong - Gong „Bim Bam“**

3/4 Westminsterschlag - 3/4 Westminster chime - 3/4 Carillon Westminster



21 x 42 cm = 8 1/4 x 16 1/2 inches



22 x 43 cm = 8 3/4 x 17 inches

**Rundgong - Gong - Gong rond - Gong redondo • Bachgong - Gong „Bim Bam“**

3/4 Westminsterschlag - 3/4 Westminster chime - 3/4 Carillon Westminster

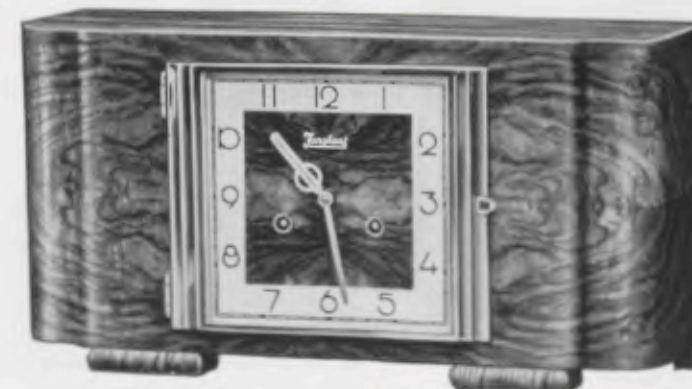

29 x 48 cm = 11 x 15 3/4 inches

**17/658** Kaukasisch Nußbaum poliert  
Polished Caucasian walnut  
Noyer Caucasiens poli  
Nogal Caúcaso pulido

**Chromlünette, Silberreif mit schwarzen Strichen**

Chromium plated bezel, silvered circle with black strokes

Lunette chromée, cercle argenté avec barres noires

Bisel cromado, cerco plateado con rayas negras

18 cm = 7 inches

**17/642** Kaukasisch Nußbaum poliert  
Polished Caucasian walnut  
Noyer Caucasiens poli  
Nogal Caúcaso pulido

**Chromlünette, Zahlenreif und Zeiger versilbert**

Chromium plated bezel, silvered figure-circle and hands

Lunette chromée, aiguilles et cercle à chiffres argentés

Bisel cromado, cerco con cifras y agujas plateados

18 cm = 7 inches

**17/655** Kaukasisch Nußbaum poliert  
Polished Caucasian walnut  
Noyer Caucasiens poli  
Nogal Caúcaso pulido

**Chromlünette, Zahlenreif versilbert**

Chromium plated bezel, silvered figure-circle

Lunette chromée, cercle à chiffres argenté

Bisel cromado, cerco con cifras plateado  
16 x 19,5 cm = 6 1/4 x 7 3/4 inches

**Rundgong - Gong - Gong rond - Gong redondo**

**Bachgong - Gong „Bim Bam“**

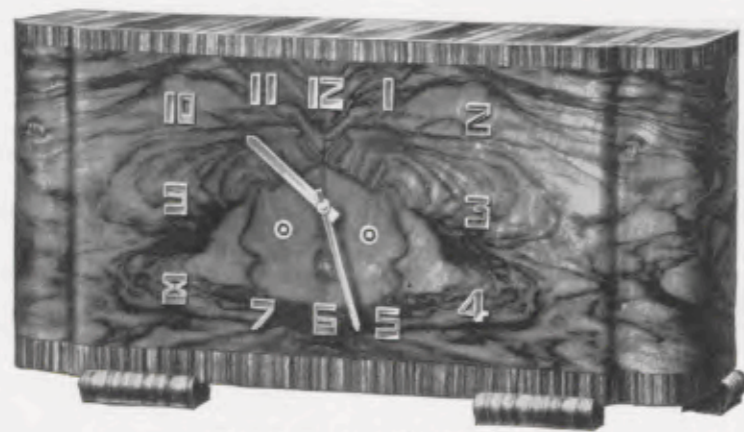

23,5 x 47 cm = 9 1/4 x 18 1/2 inches

**17/575** Kaukasisch Nußbaum poliert  
Polished Caucasian walnut  
Noyer Caucasiens poli  
Nogal Caúcaso pulido

**Verchromte Zahlen und Zeiger**  
Chromium plated figures and hands  
Chiffres et aiguilles chromés  
Cifras y agujas cromadas

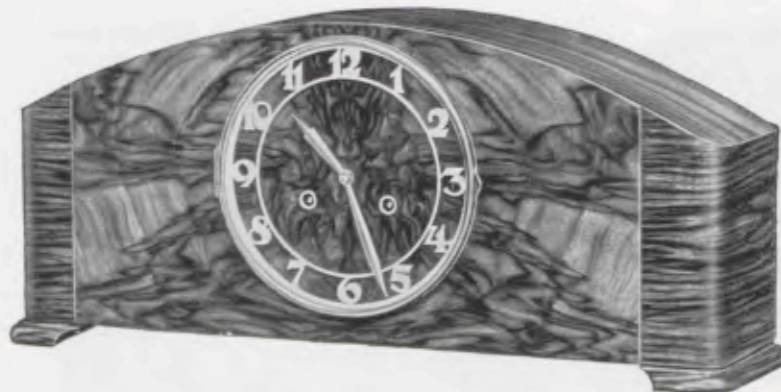

21 x 52 cm = 8 1/2 x 20 1/4 inches

**17/596** Kaukasisch Nußbaum poliert  
Polished Caucasian walnut  
Noyer Caucasiens poli  
Nogal Caúcaso pulido

**Chromlunette, Zahlenreif und Zeiger versilbert**  
Chromium plated bezel, silvered figure-circle and hands  
Lunette chromée, aiguilles et cercle à chiffres argentés  
Bisel cromado, cerco de cifras y agujas plateados  
18 cm = 7 inches

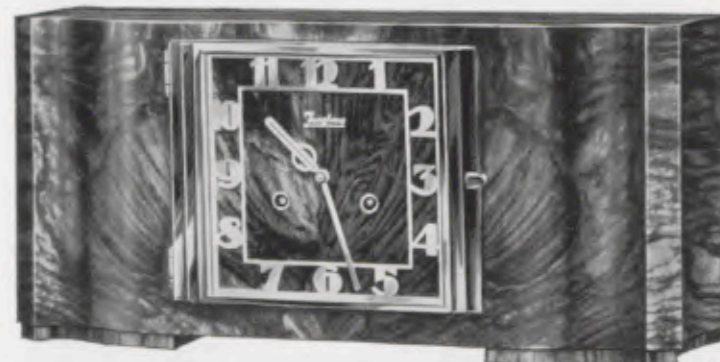

20 x 42 cm = 8 x 16 1/2 inches

**17/657** Kaukasisch Nußbaum poliert  
Polished Caucasian walnut  
Noyer Caucasiens poli  
Nogal Caúcaso pulido

**Chromlunette, Zahlenreif und Zeiger versilbert**  
Chromium plated bezel, silvered figure-circle and hands  
Lunette chromée, aiguilles et cercle à chiffres argentés  
Bisel cromado, cerco de cifras y agujas plateados  
16 x 19,5 cm = 6 1/4 x 7 3/4 inches

**Rundgong - Gong - Gong rond - Gong redondo**

**Bachgong - Gong „Bim Bam“**

3/4 Westminsterschlag - 3/4 Westminister chime - 3/4 Carillon Westminister



20 x 42 cm = 8 x 16 1/2 inches

**17/637**

**Kaukasisch Nußbaum poliert**  
Polished Caucasian walnut  
Noyer Caucasiens poli  
Nogal Caúcaso pulido  
**Chromlunette, Zahlenreif und Zeiger versilbert**  
Aufgelegte blaue Striche  
Chromium plated bezel, silvered figure-circle and hands  
Blue raised strokes  
Lunette chromée, aiguilles et cercle à chiffres argentés  
Barres bleues en relief  
Bisel cromado, cerco de cifras y agujas plateados  
Rayas azules en relieve  
16 x 19,5 cm = 6 1/4 x 7 3/4 inches

**Rundgong - Gong - Gong rond**  
Gong redondo

**Bachgong 5 Stäbe - Gong „Bim Bam“**: 5 rods - 5 tiges - 5 varillas  
3/4 Westminsterschlag - 3/4 Westminister chime - 3/4 Carillon Westminister

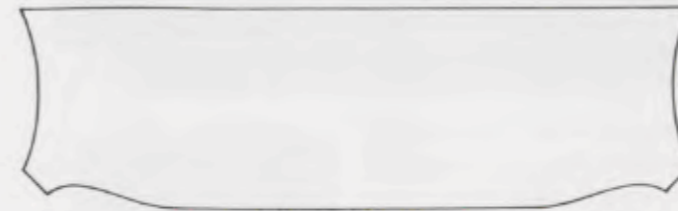

**17/597**

**Kaukasisch Nußbaum poliert**  
Polished Caucasian walnut  
Noyer Caucasiens poli  
Nogal Caúcaso pulido  
**Chromlunette, Zahlenreif und Zeiger versilbert**  
Chromium plated bezel, silvered figure-circle and hands  
Lunette chromée, aiguilles et cercle à chiffres argentés  
Bisel cromado, cerco de cifras y agujas plateados  
18 cm = 7 inches  
**Rundgong - Gong - Gong rond**  
Gong redondo  
**Bachgong 5 Stäbe - Gong „Bim Bam“**: 5 rods - 5 tiges - 5 varillas



22 x 45 cm = 8 3/4 x 17 3/4 inches

**17/598**

**Kaukasisch Nußbaum poliert**  
Polished Caucasian walnut  
Noyer Caucasiens poli  
Nogal Caúcaso pulido  
**Chromlunette, Zahlenreif und Zeiger versilbert**  
Chromium plated bezel, silvered figure-circle and hands  
Lunette chromée, aiguilles et cercle à chiffres argentés  
Bisel cromado, cerco de cifras y agujas plateados  
18 cm = 7 inches  
**Rundgong - Gong - Gong rond - Gong redondo**  
**Bachgong 5 Stäbe - Gong „Bim Bam“**: 5 rods - 5 tiges - 5 varillas  
3/4 Westminsterschlag  
3/4 Westminister chime  
3/4 Carillon Westminister



20 x 52 cm = 7 7/8 x 20 3/4 inches



Konsole No. 1 — Bracket No. 1  
Console No. 1 — Consola No. 1

18 x 6 x 16,5 cm = 22 1/4 x 2 1/4 x 6 1/2 inches

Kaukasisch Nußbaum poliert — Polished Caucasian walnut  
Noyer Caucasiens poli — Nogal Caúcaso pulido

Für alle Junghans-Tischuhren in kaukasisch Nußbaum poliert lieferbar  
Can be used for all clocks with polished Caucasian walnut  
Avec console sont livrables tous les modèles en noyer Caucasiens poli  
Con consola se suministran todos los modelos en nogal Caúcaso pulido

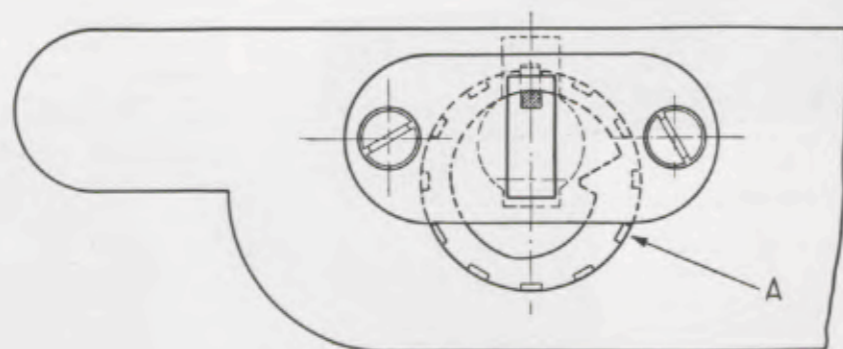

Aufhängevorrichtung der Konsole. D. R. P. A.

Durch Drehen der Scheibe A kann die Konsole jederzeit leicht in eine absolut wagrechte Lage gebracht werden.

Suspension device of bracket. Patented.

The bracket can easily be brought into an absolutely horizontal position by turning disc A.

Appareil de suspension de la console D. R. P. A.

En tournant le disque A, on peut en tout temps mettre la console en position absolument horizontale.

Aparato para suspender la consola D. R. P. A.

Dando vueltas al disco A, la consola siempre se puede poner facilmente en una posición absolutamente horizontal.



GRUPPE 18

Einsatzuhren

Rundrahmenuhren \* Bürouhren \* Dropuhren

Clocks for fitting into furniture  
Dial Clocks \* Office Clocks \* Drop Dial Clocks

Pendules à encastrer

Èils de Bœuf \* Pendules pour Bureaux \* Pendules octogones

Relojes para colocar en estantes, muebles etc.

Relojes de pared, forma ojo de buey \* Relojes para despachos

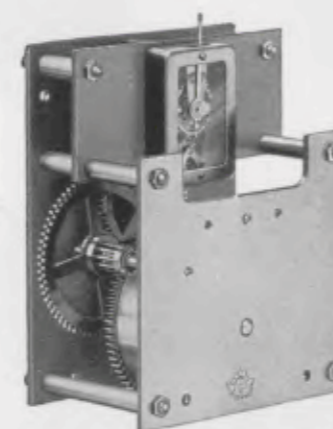

Platinen — Plates — Platines — Platinas  
9,5 x 7,5 cm = 3 3/4 x 3 inches

No. 146 8 Tag Marine-Präzisionswerk mit 7 Steinen,  
staubdicht abgedeckte Taschenuhrhemmung  
Precision lever movement, 8 day time,  
escapement with 7 jewels under dustproof  
protector  
Mouvement de précision, 8 jours simple,  
échappement hermétiquement fermé avec  
7 rubis  
Máquina de precisión, 8 días cuerda, escape  
hermético á áncora con 7 rubis

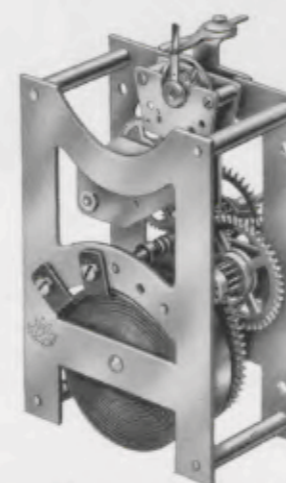

Platinen — Plates — Platines — Platinas  
9 x 6 cm = 3 1/2 x 2 1/4 inches

No. 184 8 Tag Anker-Gehwerk mit  
Echappement  
8 day lever time  
movement with escapement  
8 jours simple, échappe-  
ment à ancre  
Máquina 8 días cuerda,  
escape á áncora

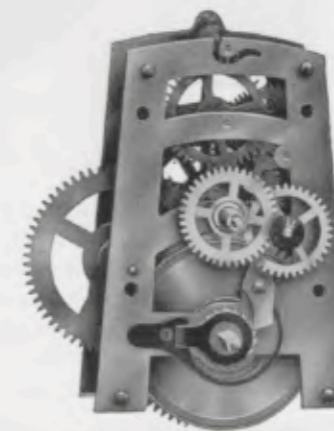

9,5 x 7 cm = 3 3/4 x 2 3/4 inches

No. 25 14 Tag Pendelgehwerk  
14 day pendulum time  
Mouvement à balancier,  
15 jours simple  
Máquina á péndola, 15 días  
cuerda

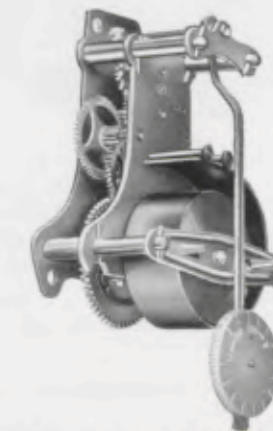

Platinen — Plates — Platines — Platinas  
7 x 6 cm = 2 3/4 x 2 1/4 inches

Werk Rap 8 Tag Pendelgehwerk  
8 day pendulum time move-  
ment  
Mouvement 8 jours simple  
à balancier  
Máquina 8 días cuerda á  
péndola



**Einsatzuhren zum Einbauen in Möbel, Büfets usw.**

Dial clocks for fitting in furniture, sideboards etc. — Pendules à encastrer pour meubles, buffets etc. — Relojes para colocar en estantes, muebles etc.



18/181

18/1  
18/182

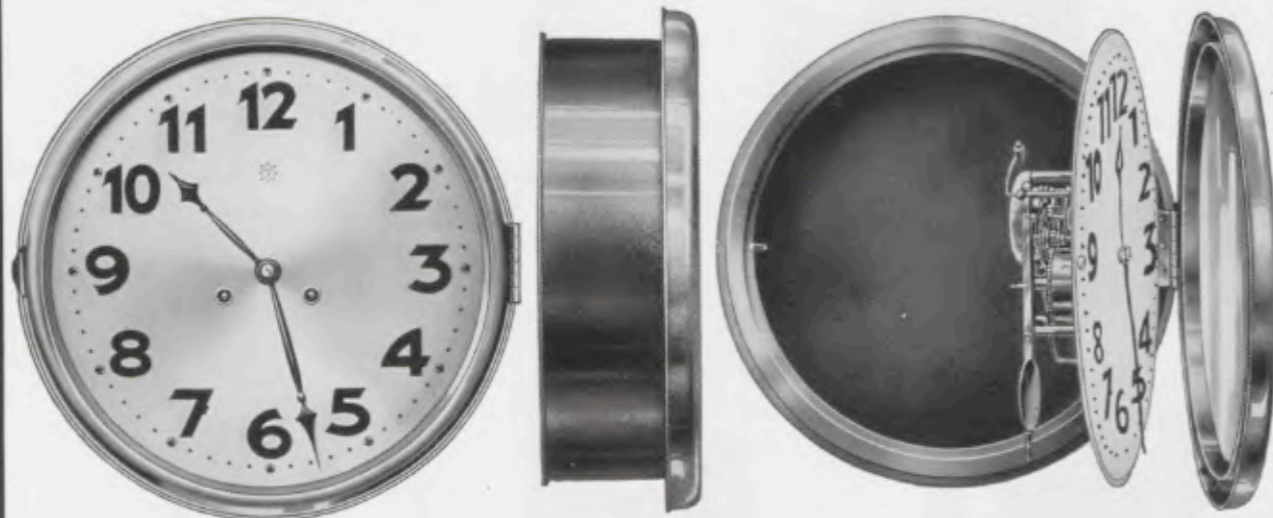

18/2  
18/3

- 18/181 8 Tag Ankergehwerk No. 146 - 8 day lever time - 8 jours simple à ancre - 8 días cuerda, escape á áncora
- 18/1 14 Tag Pendelgehwerk - 14 day pendulum time - 15 jours simple à balancier - Máquina á péndola, 15 días cuerda
- 18/182 8 Tag Ankergehwerk No. 146 - 8 day lever time - 8 jours simple à ancre - 8 días cuerda, escape á áncora
- 18/2 14 Tag Pendelgehwerk - 14 day pendulum time - 15 jours simple à balancier - Máquina á péndola, 15 días cuerda
- 18/3 14 Tag Pendelschlagwerk auf Glocke - 14 day strike on bell - 15 jours sonnerie sur timbre - Máquina á péndola, 15 días sonería sobre campana

Chromlunetten - Chromium plated bezels - Lunettes chromées - Biseles cromados

Abmessungen - Dimensions - Dimensions - Dimensiones

No. No. No. No.	Silberblatt - Silver dial - Cadran argenté - Esfera plateada		Hintergehäuse - Back case - Tambour - Caja		
	Minutenkreisdurchmesser Diameter of minute circle Diamètre du cercle minutes Diámetro del círculo de minutos	Lünettendurchmesser Diameter of bezel Diamètre extér. de la lunette Diámetro total del bisel	Durchmesser Diameter Diamètre Diámetro	Tiefe Depth Profondeur Profundidad	
18/181	164 mm = 6 1/2 inches	210 mm = 8 1/4 inches	180 mm = 7 inches	63 mm = 2 1/2 inches	
18/1	225 " = 9 "	275 " = 10 7/8 "	232 " = 9 1/8 "	80 " = 3 1/8 "	
18/182	225 " = 9 "	275 " = 10 7/8 "	232 " = 9 1/8 "	80 " = 3 1/8 "	
18/2	262 " = 10 "	332 " = 13 1/8 "	280 " = 11 "	80 " = 3 1/8 "	
18/3	262 " = 10 "	332 " = 13 1/8 "	280 " = 11 "	80 " = 3 1/8 "	



Agnes



Glaszifferblatt  
Glass dial - Cadran verre - Esfera de vidrio

Rahmen - Frame - Cadre - Marco		Zifferblatt - Dial - Cadran - Esfera	
Buche, hell poliert Light beech polished Hêtre clair poli Haya clara pulida	Nußbaumfarbig Walnut finish Teinte noyer Color nogal	Durchmesser Diameter Diamètre Diámetro	Minutenkreisdurchmesser Diameter of minute circle Diamètre du cercle minutes Diámetro del círculo de minutos
18/202	18/203	276 = 11 mm inches	184 = 7 mm inches
18/204	18/206	8 Tag Pendelgehwerk - 8 day pendulum time - 8 jours simple à balancier - 8 días cuerda á péndola	
18/205	18/207	14 Tag Gehwerk - 14 day time - 15 jours simple - 15 días cuerda	
		14 Tag Schlagwerk - 14 day strike - 15 jours sonnerie - 15 días sonería	
18/208	18/210	315 = 12 1/2 mm inches	216 = 8 1/2 mm inches
18/209	18/211	14 Tag Gehwerk - 14 day time - 15 jours simple - 15 días cuerda	
		14 Tag Schlagwerk - 14 day strike - 15 jours sonnerie - 15 días sonería	
18/212	18/213	364 = 14 1/4 mm inches	262 = 10 mm inches
		14 Tag Gehwerk - 14 day time - 15 jours simple - 15 días cuerda	
		14 Tag Schlagwerk - 14 day strike - 15 jours sonnerie - 15 días sonería	

18/202-203: mit Blechhinterkasten - with metal case - avec boîte en tôle - con caja de metal



Altai



Zelluloid-Zifferblatt, bombiertes Glas

Celluloid dial, convex glass - Cadran celluloïd, verre bombé - Esfera de celuloide, cristal bombeado

Rahmen - Frame - Cadre - Marco			Zifferblatt - Dial - Cadran - Esfera	
Buche hell poliert Light beech polished Hêtre clair poli Haya clara pulida	Nußbaumfarbig Walnut finish Teinte noyer Color nogal	Weiß lackiert White lacquered Verni blanc Barnizado es blanco	Durchmesser Diameter Diamètre Diámetro	Minutenkreisdurchmesser Diameter of minute circle Diamètre du cercle minutes Diámetro del círculo de minutos
18/216	18/217		276 = 11 mm inches	184 = 7 mm inches
18/218	18/220	18/235	8 Tag Pendelgehwerk - 8 day pendulum time - 8 jours simple à balancier - 8 días cuerda a péndola	
18/219	18/221	18/236	14 Tag Gehwerk - 14 day time - 15 jours simple - 15 días cuerda	
			14 Tag Schlagwerk - 14 day strike - 15 jours sonnerie - 15 días sonería	
18/222	18/224		315 = 12 <sup>1</sup> / <sub>2</sub> mm inches	216 = 8 <sup>1</sup> / <sub>2</sub> mm inches
18/223	18/225		14 Tag Gehwerk - 14 day time - 15 jours simple - 15 días cuerda	
			14 Tag Schlagwerk - 14 day strike - 15 jours sonnerie - 15 días sonería	
18/226	18/228		364 = 14 <sup>1</sup> / <sub>2</sub> mm inches	262 = 10 mm inches
18/227	18/229		14 Tag Gehwerk - 14 day time - 15 jours simple - 15 días cuerda	
			14 Tag Schlagwerk - 14 day strike - 15 jours sonnerie - 15 días sonería	
	18/232		400 = 15 <sup>3</sup> / <sub>4</sub> mm inches	305 = 12 mm inches
	18/233		14 Tag Gehwerk - 14 day time - 15 jours simple - 15 días cuerda	
			14 Tag Schlagwerk - 14 day strike - 15 jours sonnerie - 15 días sonería	



World II

Afrika



Lackblatt - Lacquered dial - Cadran verni - Esfera esmaltada

Rahmen - Frame - Cadre - Marco			Zifferblatt - Dial - Cadran - Esfera	
Buche hell Light beech Hêtre clair Haya color claro	Mahagonifarbig Mahogany finish Teinte acajou Color caoba	Eiche Oak Chêne Roble	Durchmesser Diameter Diamètre Diámetro	Minutenkreisdurchmesser Diameter of minute circle Diamètre du cercle minutes Diámetro del círculo de minutos
World 18/173 18/174	World 18/175 18/176		30 = 11 <sup>3</sup> / <sub>4</sub> cm inches	184 = 7 mm inches
			14 Tag Gehwerk - 14 day time - 15 jours simple - 15 días cuerda	
			14 Tag Schlagwerk - 14 day strike - 15 jours sonnerie - 15 días sonería	
			Messinglunette - Brass bezel - Lunette laiton - Bisel de latón	
World 18/169 18/170			34 = 13 <sup>1</sup> / <sub>2</sub> cm inches	225 = 9 mm inches
			14 Tag Gehwerk - 14 day time - 15 jours simple - 15 días cuerda	
			14 Tag Schlagwerk - 14 day strike - 15 jours sonnerie - 15 días sonería	
			Messinglunette - Brass bezel - Lunette laiton - Bisel de latón	
World 18/100 18/101	World 18/102 18/103		38,5 = 15 cm inches	280 = 11 mm inches
			14 Tag Gehwerk - 14 day time - 15 jours simple - 15 días cuerda	
			14 Tag Schlagwerk - 14 day strike - 15 jours sonnerie - 15 días sonería	
			Messinglunette - Brass bezel - Lunette laiton - Bisel de latón	
		Afrika 18/91 18/92	54 = 21 cm inches	360 = 14 mm inches
			14 Tag Gehwerk - 14 day time - 15 jours simple - 15 días cuerda	
			14 Tag Schlagwerk - 14 day strike - 15 jours sonnerie - 15 días sonería	
		Afrika 18/93 18/94	64 = 25 cm inches	445 = 17 <sup>1</sup> / <sub>2</sub> mm inches
			14 Tag Gehwerk - 14 day time - 15 jours simple - 15 días cuerda	
			14 Tag Schlagwerk - 14 day strike - 15 jours sonnerie - 15 días sonería	



Buenos Aires



Messinglunette, Lackblatt

Brass bezel, lacquered dial - Lunette laiton, cadran verni - Bisel de latón, esfera esmaltada

Rahmen - Frame - Cadre - Marco

Zifferblatt - Dial - Cadran - Esfera

Eiche Oak Chêne Roble	Nußbaumfarbig Walnut finish Teinte noyer Color nogal	Durchmesser Diameter Diamètre Diámetro	Minutenkreisdurchmesser Diameter of minute circle Diamètre du cercle minutes Diámetro del círculo de minutos
18/133 18/134	18/135 18/136	34 = 13 <sup>1</sup> / <sub>2</sub> cm inches	184 = 7 mm inches
		14 Tag Gehwerk - 14 day time - 15 jours simple - 15 días cuerda 14 Tag Schlagwerk - 14 day strike - 15 jours sonnerie - 15 días sonería	
18/137 18/138	18/139 18/140	38 = 15 cm inches	225 = 9 mm inches
		14 Tag Gehwerk - 14 day time - 15 jours simple - 15 días cuerda 14 Tag Schlagwerk - 14 day strike - 15 jours sonnerie - 15 días sonería	
18/141 18/142	18/143 18/144	46 = 18 cm inches	262 = 10 mm inches
		14 Tag Gehwerk - 14 day time - 15 jours simple - 15 días cuerda 14 Tag Schlagwerk - 14 day strike - 15 jours sonnerie - 15 días sonería	

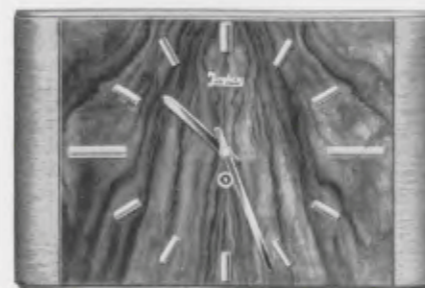

22 x 34 cm = 8 <sup>3</sup>/<sub>4</sub> x 13 <sup>1</sup>/<sub>2</sub> inches

18/260 Eiche mit polierter Nußbaum-Vorderplatte  
Oak with polished walnut  
Chêne avec noyer poli  
Roble con nogal pulido  
Verchromte Striche und Zeiger  
Chromium plated strokes and hands  
Barres et aiguilles chromées - Rayas y agujas cromadas



23 x 29 cm = 9 x 11 <sup>1</sup>/<sub>2</sub> inches

18/261 Eiche mit Nußbaum poliert - Oak with polished walnut - Chêne avec noyer poli - Roble con nogal pulido  
Verchromte Zahlen und Zeiger  
Chromium plated figures and hands  
Chiffres et aiguilles chromés - Cifras y agujas cromadas

8 Tag Pendelgehwerk Rap - 8 day pendulum time movement Rap - Mouvement 8 jours simple à balancier Rap - Máquina 8 días cuerda á péndola Rap



24,5 x 37 cm = 9 <sup>1</sup>/<sub>2</sub> x 14 <sup>1</sup>/<sub>2</sub> inches

18/272 Kaukas. Nußbaum poliert mit Schleiflack, elfenbeinfarbig - Polished Caucasian walnut with varnished ivory dull - Noyer Caucasiens poli avec peinture ivoire lacquée dépolie - Nogal Cáucaso pulido con barniz pulido mate, marfil  
Schwarze Striche und Zeiger - Black strokes and hands - Barres et aiguilles noires - Rayas y agujas negras

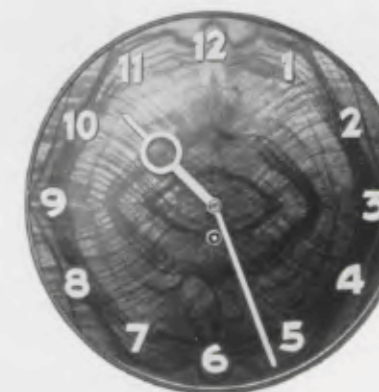

30 cm = 11 <sup>3</sup>/<sub>4</sub> inches  
Profil siehe Seite 75

Verchromtes Gehäuse - Chromium plated case  
Boîte chromée - Caja cromada  
18/259 Z Zahlen - Figures - Chiffres - Cifras  
18/259 S Striche - Strokes - Barres - Rayas  
Zifferblatt kaukas. Nußbaum poliert  
Dial polished Caucasian walnut  
Cadran noyer Caucasiens poli  
Esfera nogal Cáucaso pulido  
18/271 Z Zahlen - Figures - Chiffres - Cifras  
Zifferblatt Eiche - Oak dial - Cadran chêne - Esfera roble

8 Tag Ankergehwerk mit Echappement - 8 day lever time movement with escapement  
8 jours simple, échappement à ancre - Máquina 8 días cuerda, escape á áncora



18,5 x 25,5 cm = 7 1/4 x 10 inches

18/276



18,5 x 25,5 cm = 7 1/4 x 10 inches

18/277



22 x 28,5 cm = 8 1/2 x 11 1/4 inches

18/278



22 x 28,5 cm = 8 1/2 x 11 1/4 inches

18/279



22 x 28,5 cm = 8 1/2 x 11 1/4 inches

18/280

Polierte Zahlen und Zeiger  
Polished figures and hands  
Chiffres et aiguilles polis  
Cifras y agujas pulidas

8 Tag Pendelgehwerk - 8 day pendulum time movement  
Mouvement 8 jours simple à balancier - Máquina 8 días cuerda á péndola



22 x 28,5 cm = 8 1/2 x 11 1/4 inches

18/281

Polierte Zahlen und Zeiger - Polished figures and hands - Chiffres et aiguilles polis - Cifras y agujas pulidas



22 x 28,5 cm = 8 1/2 x 11 1/4 inches

18/282



22 x 28,5 cm = 8 1/2 x 11 1/4 inches

18/283

Polierte Zahlen und Zeiger - Polished figures and hands - Chiffres et aiguilles polis - Cifras y agujas pulidas

8 Tag Pendelgehwerk - 8 day pendulum time movement  
Mouvement 8 jours simple à balancier - Máquina 8 días cuerda á péndola



24,5 x 37 cm = 9 1/2 x 14 1/4 inches

18/275

Schwarze Zahlen und Zeiger  
Black figures and hands  
Chiffres et aiguilles noirs  
Cifras y agujas negras

8 Tag Pendelgehwerk Rap - 8 day pendulum time movement Rap  
Mouvement 8 jours simple à balancier Rap - Máquina 8 días cuerda á péndola Rap



24 x 24 cm = 9 1/2 x 9 1/2 inches

18,268

Schwarze Zahlen und Zeiger  
Black figures and hands  
Chiffres et aiguilles noirs  
Cifras y agujas negras



24 x 24 cm = 9 1/2 x 9 1/2 inches

18,269

Matte Zahlen und Zeiger  
Mat figures and hands  
Chiffres et aiguilles mats  
Cifras y agujas mate



24 x 24 cm = 9 1/2 x 9 1/2 inches

18,270

Buche-Rahmen - Beech frame  
Cadre en hêtre - Marco haya

Schwarze Zahlen und Zeiger  
Black figures and hands  
Chiffres et aiguilles noirs  
Cifras y agujas negras

8 Tag Pendelgehwerk - 8 day pendulum time movement  
Mouvement 8 jours simple à balancier - Máquina 8 días cuerda á péndola



22 x 29 cm = 8 1/2 x 11 1/2 inches

18,250



22 x 29 cm = 8 1/2 x 11 1/2 inches

18,252



22 x 29 cm = 8 1/2 x 11 1/2 inches

18,251

18,274 Z Verchromte Zahlen und Zeiger - Chromium plated figures and hands  
Chiffres et aiguilles chromées - Cifras y agujas cromadas

18,274 S Verchromte Striche und Zeiger - Chromium plated strokes and hands  
Barres et aiguilles chromées - Rayas y agujas cromadas

Schleiflackgehäuse - Lacquered cases  
Cages laquées dépolies - Cajas barniz pulido mate

8 Tag Pendelgehwerk Rap - 8 day pendulum time movement Rap  
Mouvement 8 jours simple à balancier Rap - Máquina 8 días cuerda á péndola Rap





25 x 30 cm = 9 7/8 x 11 7/8 inches

18/248

Schleiflackgehäuse - Lacquered case

Cage laquée dépolie - Caja barniz pulido mate

Verchromte Zahlen und Zeiger - Chromium plated figures and hands

Chiffres et aiguilles chromés - Cifras y agujas cromadas

8 Tag Ankergehwerk mit Echappement - 8 day lever time with escapement

8 jours simple, échappement à ancre - Máquina 8 días cuerda, escape á áncora



22 x 29 cm = 8 5/8 x 11 1/2 inches

18/253

Polierte Zahlen und Zeiger

Polished figures and hands

Chiffres et aiguilles polis

Cifras y agujas pulidas

Schleiflack mit Birkenmaserleiste - Lacquered cases with bur birch

Cages laquées dépolies avec loupe de bouleau - Cajas barniz pulido mate con abedul negro

8 Tag Pendelgehwerk Rap - 8 day pendulum time movement Rap

Mouvement 8 jours simple à balancier Rap - Máquina 8 días cuerda á péndola Rap



25 x 30 cm = 9 7/8 x 11 7/8 inches

18/254

Verchromte Zahlen und Zeiger

Chromium plated figures and hands

Chiffres et aiguilles chromés

Cifras y agujas cromadas



22 x 33 cm = 8 7/8 x 13 inches

18/263 Zahlen - Figures - Chiffres - Cifras

18/266 Striche - Strokes - Barres - Rayas



22 x 33 cm = 8 7/8 x 13 inches

18/264 Zahlen - Figures - Chiffres - Cifras

18/267 Striche - Strokes - Barres - Rayas



22 x 33 cm = 8 7/8 x 13 inches

18/265 Zahlen - Figures - Chiffres - Cifras

Schleiflackgehäuse - Lacquered cases - Cages laquées dépolies

Cajas barniz pulido mate

8 Tag Pendelgehwerk Rap - 8 day pendulum time movement Rap

Mouvement 8 jours simple à balancier Rap - Máquina 8 días cuerda á péndola Rap



30 cm = 11 3/4 inches

18/255 Z Zahlen - Figures - Chiffres  
Cifras  
18/255 S Striche - Strokes - Barres  
Rayas



30 cm = 11 3/4 inches

18/256 Z Zahlen - Figures - Chiffres  
Cifras  
18/256 S Striche - Strokes - Barres  
Rayas



30 cm = 11 3/4 inches

18/257 Z Zahlen - Figures - Chiffres  
Cifras  
18/257 S Striche - Strokes - Barres  
Rayas



30 cm = 11 3/4 inches

18/258 Z Zahlen - Figures - Chiffres  
Cifras  
18/258 S Striche - Strokes - Barres  
Rayas

Verchromte Gehäuse mit Schleiflackfront - Chromium plated cases with lacquered front  
Cajas cromadas con cadran laqué dépoli - Cajas cromadas con esfera barniz pulido mate

8 Tag Ankergehwerk mit Echappement - 8 day lever time movement with escapement  
8 jours simple, échappement à ancre - Máquina 8 días cuerda, escape à âncora



Calcutta

Rangoon



40,5 x 24,5 cm = 16 x 9 1/2 inches

18/71



49 x 31 cm = 19 1/2 x 12 1/4 inches

18/96

Lackblatt - Lacquered dial - Cadran verni - Esfera esmaltada

Name Name Nom Nombre	Rahmen - Frame - Cadre - Marco			Zifferblatt - Dial - Cadran - Esfera
	Buche hell Light beech Hêtre clair Haya color claro	Mahagonifarbig Mahogany finish Teinte acajou Color caoba	Durchmesser Diameter Diamètre Diámetro	Minutenkreisdurchmesser Diameter of minute circle Diamètre du cercle minutes Diámetro del círculo de minutos
Calcutta	18/71	—	24,5 cm = 9 1/2 inches	139 mm = 5 1/2 inches
Rangoon	—	18/96	31 cm = 12 1/4 inches	184 mm = 7 inches

14 Tag Schlagwerk mit Tonfeder

14 day strike - 15 jours sonnerie sur ressort timbre - 15 días sonería sobre timbre bordón



Office



65 x 41 cm = 25 1/2 x 16 inches

Lackblatt - Lacquered dial - Cadran verni - Esfera esmaltada

Name Name Nom Nombre	Zifferblatt - Dial - Cadran - Esfera		Rahmen - Frame - Cadre - Marco
	Nußbaum poliert Polished walnut Noyer poli Nogal pulido	Durchmesser Diameter Diamètre Diámetro	Minutenkreisdurchmesser Diameter of minute circle Diamètre du cercle minutes Diámetro del círculo de minutos
Office	18/42	41 cm = 16 inches	262 mm = 10 inches

Schwarze und goldfarbige Verzierungen - Black and gold coloured metal decorations  
Garnitures couleur noir et or - Adornos negros y de color oro

14 Tag Schlagwerk mit Tonfeder  
14 day strike - 15 jours sonnerie sur ressort timbre - 15 días sonería sobre timbre bordón



GRUPPE 19

Küchenuhren in Steingut

Kitchen and Nursery Clocks in earthenware cases - Pendules pour cuisine, cages en faïence - Relojes para cocina, cajas en loza



20 cm = 7 1/4 inches

19/342



20 cm = 7 1/4 inches

19/344



20 cm = 7 1/4 inches

19/346

1 Tag Ankergehwerk - 1 day lever time movement  
Mouvement 30 heures simple à ancre - Máquina 30 horas á áncora

19/343

19/345

19/347

8 Tag Pendelgehwerk - 8 day pendulum time movement  
Mouvement 8 jours simple à balancier - Máquina 8 días cuerda á péndola



20 x 24 cm = 8 x 9 1/2 inches

19/352



20 x 24 cm = 8 x 9 1/2 inches

19/354



20 x 24 cm = 8 x 9 1/2 inches

19/365

1 Tag Ankergehwerk - 1 day lever time movement  
Mouvement 30 heures simple à ancre - Máquina 30 horas cuerda á áncora

19/353

19/355

19/366

8 Tag Pendelgehwerk Rap - 8 day pendulum time movement Rap  
Mouvement 8 jours simple à balancier Rap - Máquina 8 días cuerda á péndola Rap

Geschlossene Kapsel - Closed back-case - Capsule fermée - Cápsula cerrada



20 x 24 cm = 8 x 9 1/2 inches

19/368

**1 Tag Ankergehwerk**  
1 day lever time movement  
Mouvement 30 heures simple à ancre  
Máquina 30 horas cuerda á áncora

19/369

**8 Tag Pendelgehwerk Rap**  
8 day pendulum time movement Rap  
Mouvement 8 jours simple à balancier Rap  
Máquina 8 días cuerda á péndola Rap



24 cm = 9 1/2 inches

19/318

**8 Tag Pendelgehwerk**  
8 day pendulum time movement  
Mouvement 8 jours simple à balancier  
Máquina 8 días cuerda á péndola



24 cm = 9 1/2 inches

19/319



24 cm = 9 1/2 inches

19/348



24 cm = 9 1/2 inches

19/349



24 cm = 9 1/2 inches

19/367

**8 Tag Pendelgehwerk - 8 day pendulum time movement**  
Mouvement 8 jours simple à balancier - Máquina 8 días cuerda á péndola  
**Geschlossene Kapsel - Closed back-case - Capsule fermée - Cápsula cerrada**



24 cm = 9 1/2 inches

19/340

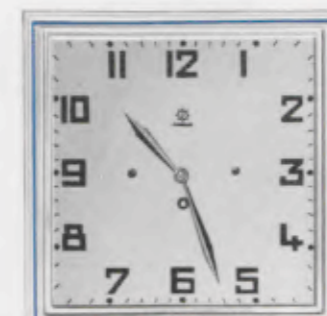

24 cm = 9 1/2 inches

19/370



24 cm = 9 1/2 inches

19/371

**8 Tag Pendelgehwerk - 8 day pendulum time movement**  
Mouvement 8 jours simple à balancier - Máquina 8 días cuerda á péndola



20 x 26 cm = 8 x 10 1/4 inches

19/357



20 x 26 cm = 8 x 10 1/4 inches

19/358



20 x 26 cm = 8 x 10 1/4 inches

19/359 **Z** Zahlen - Figures - Chiffres  
Cifras

19/359 **S** Striche - Strokes - Barres  
Rayas

**8 Tag Pendelgehwerk Rap - 8 day pendulum time movement Rap**  
Mouvement 8 jours simple à balancier Rap - Máquina 8 días cuerda á péndola Rap

19/361

19/362

19/363 **Z** Zahlen - Figures - Chiffres  
Cifras

19/363 **S** Striche - Strokes - Barres  
Rayas

**Sehr flaches 8 Tag Ankergehwerk - Very flat 8 day lever time movement**  
Mouvement très plat, 8 jours simple à ancre - Máquina muy plana de 8 días cuerda á áncora

**Geschlossene Kapsel - Closed back-case - Capsule fermée - Cápsula cerrada**



20 x 26 cm = 8 x 10 1/4 inches

19/360 Z Zahlen - Figures - Chiffres  
Cifras

19/360 S Striche - Strokes - Barres  
Rayas

8 Tag Pendelgehwerk Rap

8 day pendulum time movement Rap  
Mouvement 8 jours simple à balancier Rap  
Máquina 8 días cuerda á péndola Rap

19/364 Z Zahlen - Figures - Chiffres  
Cifras

19/364 S Striche - Strokes - Barres  
Rayas

Sehr flaches 8 Tag Ankergehwerk

Very flat 8 day lever time movement  
Mouvement très plat, 8 jours simple  
à ancre

Máquina muy plana de 8 días cuerda  
á áncora



24 cm = 9 1/2 inches

19/350



24 cm = 9 1/2 inches

19/351

Sehr flaches 8 Tag Ankergehwerk

Very flat 8 day lever time movement  
Mouvement très plat, 8 jours simple à ancre  
Máquina muy plana de 8 días cuerda á áncora



28 x 28 cm = 11 x 11 inches

19/372



28 x 28 cm = 11 x 11 inches

19/373

8 Tag Pendelgehwerk - 8 day pendulum time movement

Mouvement 8 jours simple à balancier - Máquina 8 días cuerda á péndola

Geschlossene Kapsel - Closed back-case - Capsule fermée - Cápsula cerrada



20/4



20/5

Rahmen - Frame

Cadre - Marco

21,5 cm = 8 1/2 inches

1 Tag Schlagwerk auf Glocke

1 day strike on bell

30 heures sonnerie sur cloche

30 horas sonería sobre campana

Rahmen nußbaumfarbig, Glaszifferblatt - Frame walnut finish, glass dial  
Cadre teinté noyer, cadran verre - Marco color nogal, esfera de vidrio

Messing-Garnitur - Brass fittings - Garniture laiton - Orladura de latón



Rahmen - Frame  
Cadre - Marco  
21,5 cm = 8½ inches

20/6 Zahlen - Figures - Chiffres - Cifras  
20/7 Striche - Strokes - Barres - Rayas



20/8 Zahlen - Figures - Chiffres - Cifras  
20/9 Striche - Strokes - Barres - Rayas

1 Tag Schlagwerk auf Glocke  
1 day strike on bell  
30 heures sonnerie sur cloche  
30 horas sonería sobre campana

Holz-Rahmen, matt lackiert, Glaszifferblatt - Wooden frame, mat lacquered, glass dial  
Cadre en bois, laqué mat, cadran verre - Marco de madera, barnizado mate, esfera de vidrio

Messing-Garnitur - Brass fittings - Garniture laiton - Orladura de latón



GRUPPE 21

Regulateure

Regulators - Régulateurs - Reguladores

Mosel III



68 x 27 cm = 26¼ x 10½ inches

21/12 Auch mit Adleraufsatz lieferbar  
Also with eagle instead of horse  
Livrabile aussi avec aigle au lieu du cheval  
Se suministra también con aderezo de águila

Zelluloidblatt - Celluloid dial - Cadran celluloid - Esfera de celuloide  
12,6 cm = 5 inches

Nußbaum poliert, 14 Tag Schlagwerk

Polished walnut, 14 day strike - Noyer poli, 15 jours sonnerie - Nogal pulido, 15 días sonería

Weser



89,5 x 35 cm = 34¼ x 13¾ inches

21/32

14,5 cm = 5¾ inches



Isar



108 x 39 cm = 42 1/2 x 15 1/4 inches

21/53 Auch mit Adleraufsatz lieferbar  
Also with eagle instead of horse  
Livvable aussi avec aigle au lieu du cheval  
Se suministra también con aderezo de águila

Zelluloidblatt - Celluloid dial - Cadran celluloid - Esfera de celuloide 14,5 cm = 5 3/4 inches

Nußbaum poliert, 14 Tag Schlagwerk  
Polished walnut, 14 day strike - Noyer poli, 14 jours sonnerie - Nogal pulido, 15 días sonería

Glasseiten - Glass sides - Côtés en verre - Lados en vidrio



GRUPPEN 23, 24, 25

## Wanduhren

Regulators - Régulateurs - Reguladores

No. 202 A

14 Tag Halbstund-Rechenschlagwerk auf Gong und Bim Bam - Neue zweckmäßige Hammerhebung - Voller, schöner Schlag durch neue Hammeranordnung - Herausnehmbare Federhäuser - Die zweckmäßige Konstruktion erlaubt leichtes Reparieren

14 day half-hour rack-strike movement on Gong and Bim Bam - New efficacious hammer-lifting - Full, nice strike by new arrangement of hammers - Interchangeable spring barrels - Easy to repair

Mouvement à rateau 15 jours sonnerie heures et demies sur Gong et Bim Bam - Élévation nouvelle et pratique des marteaux - Sonnerie pleine et belle grâce à une nouvelle disposition des marteaux - Barillets interchangeables - Facile à réparer

Máquina á sierra 15 días sonería horas y medias sobre Gong y Bim Bam - Elevación nueva y práctica de los martillos - Sonería plena y bonita que se ha obtenido por medio de una nueva disposición de los martillos Barilletes intercambiables - Se deja reparar facilmente

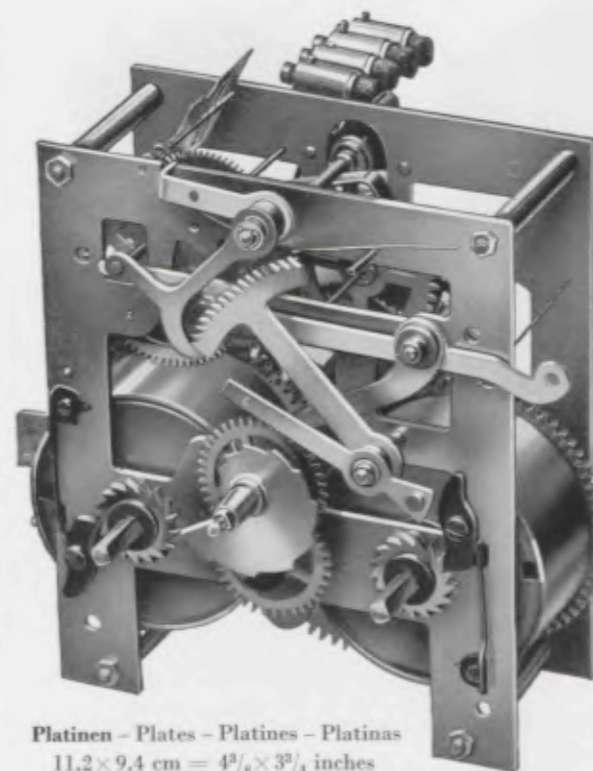

Platinen - Plates - Platines - Platinas  
11,2 x 9,4 cm = 4 3/8 x 3 3/4 inches

No. 103

Platinen - Plates - Platines - Platinas  
14,5 x 13,5 cm = 5 3/4 x 5 1/4 inches

8 Tag 1/4 Westminster-Schlagwerk No. 103 mit 5 Stäben - 8 day 1/4 Westminster chime movement No. 103 with 5 rodgongs  
8 jours sonnerie 1/4 Carillon Westminster sur 5 tiges, mouvement No. 103 - 8 días sonería 1/4 Carillon Westminster sobre 5 varillas, máquina No. 103

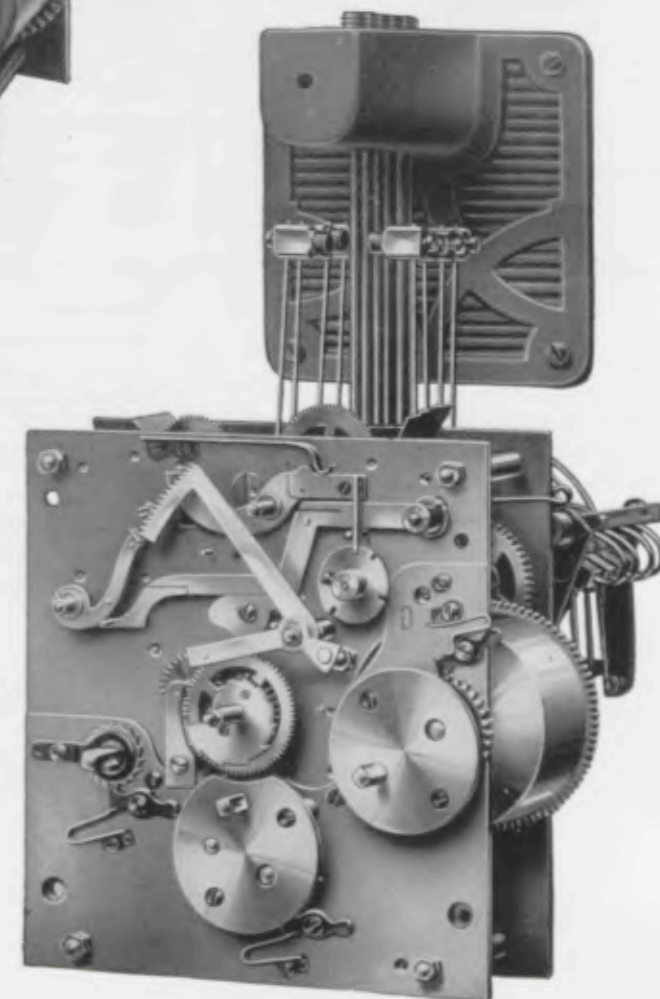



Colombo



60 x 33 cm = 23 3/8 x 13 inches

**23,86** Eichenfarbig - Oak finish - Teinte chêne - Color roble

**23,87** Nußbaumfarbig - Walnut finish - Teinte noyer - Color nogal

Lackzifferblatt - Lacquered dial - Cadran verni - Esfera esmaltada

8 Tag Rechenschlag, offene Federn - 8 day half hour rack strike, open springs - 8 jours sonnerie à râteau heure et demie, ressorts découverts - 8 días sonería á sierra hora y media, cuerdas descubiertas

Eichengehäuse in allen Eichenfarben lieferbar - Oak cases can be had in all oak colours  
Les cages chêne se livrent en toutes teintes de chêne - Las cajas de roble se hacen en todos los colores

Silberblatt - Silver dial - Cadran argenté - Esfera plateada 14,5 cm = 5 3/4 inches

Norden



52 x 26 cm = 20 1/2 x 10 1/4 inches

**23,81** Eiche - Oak - Chêne - Roble

Gewöhnliche Gläser  
Plain glasses  
Verres simples  
Vidrios ordinarios

**23,83** Eiche - Oak - Chêne - Roble

Facettegläser  
Bevelled glasses  
Glaces biseautées  
Vidrios biselados

14 Tag 1/2 Stund-Schlagwerk, Tonfeder - Stabgong - Bachgong  
14 day 1/2 hour strike, plain strike - Rod gong - Gong „Bim Bam“  
15 jours sonnerie, heures et demies, ressort timbre - Gong tige  
Gong „Bim Bam“  
15 días sonería, horas y medias, sonería sobre bordón  
Sonería sobre gong tija - Gong „Bim Bam“

Neu-Villach



49 x 23,5 cm = 19 1/4 x 9 1/4 inches

**23,79** Nußbaumfarbig  
Walnut finish  
Teinte noyer  
Color nogal



Neu-Bruck I



54,5 x 25,5 cm = 21 1/2 x 10 inches

**23,88** Eiche - Oak - Chêne - Roble

**23,89** Nußbaum - Walnut - Noyer  
Nogal

Neu-Bruck II



54,5 x 25,5 cm = 21 1/2 x 10 inches

**23,90** Eiche - Oak - Chêne - Roble

**23,91** Nußbaum - Walnut - Noyer  
Nogal

Neu-Bruck III



54,5 x 25,5 cm = 21 1/2 x 10 inches

**23,92** Eiche - Oak - Chêne - Roble

**23,93** Nußbaum - Walnut - Noyer  
Nogal

14 Tag 1/2 Stund-Schlagwerk, Tonfeder - Stabgong - Bachgong  
14 day 1/2 hour strike, plain strike - Rod gong - Gong „Bim Bam“  
15 jours sonnerie, heures et demies, ressort timbre - Gong tige - Gong „Bim Bam“  
15 días sonería, horas y medias, sonería sobre bordón - Sonería sobre gong tija - Gong „Bim Bam“

Eichengehäuse in allen Eichenfarben lieferbar - Oak cases can be had in all oak colours  
Les cages chêne se livrent en toutes teintes de chêne - Las cajas de roble se hacen en todos los colores

Silberblatt - Silver dial - Cadran argenté - Esfera plateada 15 cm = 6 inches





52 x 28 cm = 20 1/2 x 11 inches



55 x 28 cm = 21 1/4 x 11 inches

24/126 Eiche - Oak - Chêne - Roble

1 Tag Schlagwerk auf Tonfeder  
1 day strike on plain strike  
30 heures sonnerie sur ressort timbre  
30 horas sonería sobre bordón

24/127 Eiche - Oak - Chêne - Roble

8 Tag 1/2 Stund-Schlagwerk, Tonfeder  
oder Bachgong - 8 day 1/2 hour strike,  
plain strike or Gong „Bim Bam“  
8 jours sonnerie, heures et demies, ressort  
timbre ou Gong „Bim Bam“ - 8 días  
sonería, horas y medias, sonería sobre  
bordón ó sonería sobre Gong „Bim Bam“

In allen Eichenfarben lieferbar - Can be had in all oak colours

Livrables en toutes teintes de chêne - Las cajas de roble se hacen en todos los colores

Silberblatt - Silver dial - Cadran argenté - Esfera plateada 18 cm = 7 inches

24/119 Eiche - Oak - Chêne - Roble

14 Tag 1/2 Stund-Schlagwerk, Tonfeder  
oder Bachgong - 14 day 1/2 hour strike,  
plain strike or Gong „Bim Bam“  
15 jours sonnerie, heures et demies, res-  
sort timbre ou Gong „Bim Bam“  
15 días sonería, horas y medias, sonería  
sobre bordón ó sonería sobre Gong  
„Bim Bam“



Gossau I und II



63,5 x 31,5 cm = 25 x 12 1/4 inches

Gossau IV



63,5 x 31,5 cm = 25 x 12 1/4 inches

24/111 Eiche - Oak - Chêne - Roble

24/115 Eiche - Oak - Chêne - Roble

24/112 Nußbaum - Walnut - Noyer - Nogal

24/116 Nußbaum - Walnut - Noyer - Nogal

Gewöhnliche Gläser - Plain glasses  
Verres simples - Vidrios ordinarios

24/113 Eiche - Oak - Chêne - Roble

24/114 Nußbaum - Walnut - Noyer - Nogal

Facettegläser - Bevelled glasses  
Glaces biseautées - Vidrios biselados

Tonfeder - Waldgong - Bachgong

Plain strike - Waldgong - Gong „Bim Bam“

Ressort timbre - Waldgong - Gong „Bim Bam“

Sonería sobre: Bordón - Waldgong - Gong „Bim Bam“

Eichengehäuse in allen Eichenfarben lieferbar - Oak cases can be had in all oak colours

Les cages chêne se livrent en toutes teintes de chêne - Las cajas de roble se hacen en todos los colores

Zifferblatt - Dial - Cadran - Esfera 18 cm = 7 inches



Überlingen I



65 x 31 cm = 25 1/2 x 12 1/4 inches

24/120

Überlingen II



65 x 31 cm = 25 1/2 x 12 1/4 inches

24/122

Eiche - Oak - Chêne - Roble

Überlingen IV



65 x 31 cm = 25 1/2 x 12 1/4 inches

24/124

24/121

24/123

Nußbaum - Walnut - Noyer - Nogal

24/125

Tonfeder - Waldgong - Bachgong - 1/4 Westminsterschlag

Plain strike - Waldgong - Gong „Bim Bam“ - 1/4 Westminster chime

Ressort timbre - Waldgong - Gong „Bim Bam“ - 1/4 Carillon Westminster

Sonería sobre bordón - Waldgong - Gong „Bim Bam“ - 1/4 Carillon Westminster

Eichengehäuse in allen Eichenfarben lieferbar - Oak cases can be had in all oak colours  
Les cages chêne se livrent en toutes teintes de chêne - Las cajas de roble se hacen en todos los colores

Zifferblatt - Dial - Cadran - Esfera 18 cm = 7 inches



Meiringen



64,5 x 30 cm = 25 1/4 x 12 inches

24 80

Mahagoni - Mahogany - Acajou - Caoba

Tonfeder - Waldgong - Bachgong - 1/4 Westminsterschlag

Plain strike - Waldgong - Gong „Bim Bam“ - 1/4 Westminster chime

Ressort timbre - Waldgong - Gong „Bim Bam“ - 1/4 Carillon Westminster

Sonería sobre bordón - Waldgong - Gong „Bim Bam“ - 1/4 Carillon Westminster

Zifferblatt - Dial - Cadran - Esfera 18 cm = 7 inches



15

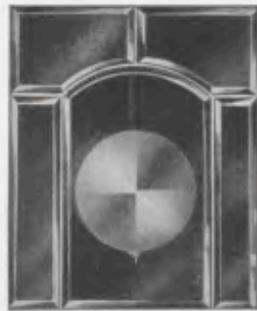

44

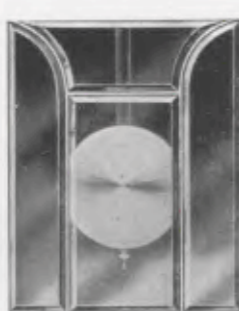

141

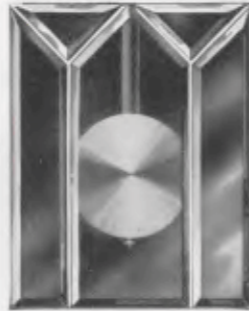

142



143



188

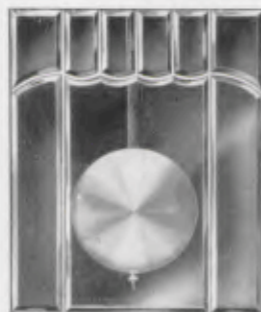

189



145



146



93

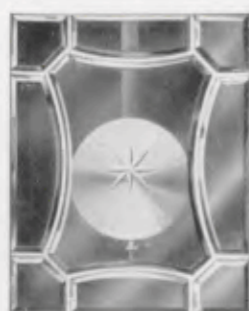

147



148



Die Regulateure der Gruppe 25 mit rechteckigen Verglasungen können auch mit den hier abgebildeten Messingverglasungen geliefert werden.

The regulators of group 25 fitted with square brass frames can also be had with the above shown fittings.

Les régulateurs de la série 25 avec panneaux de glaces carrées peuvent être fournis avec les panneaux de glaces serties en laiton suivant gravures ci-dessus.

Los reguladores del grupo 25 con vidrieras rectangulares se montan además con las vidrieras de los dibujos, que se ven más arriba.



Kassel I und II



78 x 33 cm = 30 3/4 x 13 inches

Kassel IV



78 x 33 cm = 30 3/4 x 13 inches

- 25 466 Eiche - Oak - Chêne - Roble
- 25 467 Nußbaum - Walnut - Noyer - Nogal
- Gewöhnliche Gläser - Plain glasses
- Verres simples - Vidrios ordinarios
- 25 468 Eiche - Oak - Chêne - Roble
- 25 469 Nußbaum - Walnut - Noyer - Nogal

Facettegläser - Bevelled glasses  
Glaces biseautées - Vidrios biselados

Waldgong - Bachgong - 1/4 Westminsterschlag  
Waldgong - Gong „Bim Bam“ - 1/4 Westminster chime  
Waldgong - Gong „Bim Bam“ - 1/4 Carillon Westminster  
Soneria sobre Waldgong - Gong „Bim Bam“ - 1/4 Carillon Westminster

Eichengehäuse in allen Eichenfarben lieferbar - Oak cases can be had in all oak colours  
Les cages chêne se livrent en toutes teintes de chêne - Las cajas de roble se hacen en todos los colores

Zifferblatt - Dial - Cadran - Esfera 18 cm = 7 inches



Kiel I



78 x 33 cm = 30 3/4 x 13 inches

Kiel II

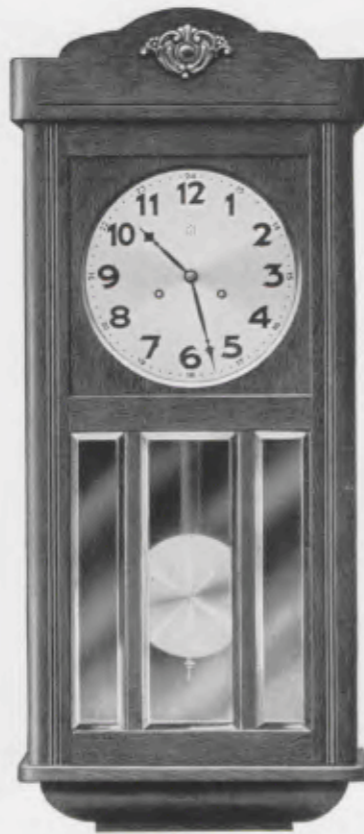

78 x 33 cm = 30 3/4 x 13 inches

Kiel IV



78 x 33 cm = 30 3/4 x 13 inches

- 25/367 Nußbaum - Walnut - Noyer  
Nogal  
25/368 Eiche - Oak - Chêne - Roble

- 25/370 Eiche - Oak - Chêne - Roble

- 25/371 Nußbaum - Walnut - Noyer  
Nogal  
25/372 Eiche - Oak - Chêne - Roble

Waldgong - Bachgong - 1/4 Westminsterschlag  
Waldgong - Gong „Bim Bam“ - 1/4 Westminster chime  
Waldgong - Gong „Bim Bam“ - 1/4 Carillon Westminster  
Sonería sobre Waldgong - Gong „Bim Bam“ - 1/4 Carillon Westminster

Eichengehäuse in allen Eichenfarben lieferbar - Oak cases can be had in all oak colours  
Les cages chêne se livrent en toutes teintes de chêne - Las cajas de roble se hacen en todos los colores

Zifferblatt - Dial - Cadran - Esfera 20,5 cm = 8 inches



Lüneburg I



78 x 33 cm = 30 3/4 x 13 inches

Lüneburg II



78 x 33 cm = 30 3/4 x 13 inches

Lüneburg IV



78 x 33 cm = 30 3/4 x 13 inches

- 25/484 Eiche - Oak - Chêne - Roble  
25/485 Nußbaum - Walnut - Noyer  
Nogal

- 25/486 Eiche - Oak - Chêne - Roble

- 25/487 Eiche - Oak - Chêne - Roble  
25/488 Nußbaum - Walnut - Noyer  
Nogal

Waldgong - Bachgong - 1/4 Westminsterschlag  
Waldgong - Gong „Bim Bam“ - 1/4 Westminster chime  
Waldgong - Gong „Bim Bam“ - 1/4 Carillon Westminster  
Sonería sobre Waldgong - Gong „Bim Bam“ - 1/4 Carillon Westminster

Eichengehäuse in allen Eichenfarben lieferbar - Oak cases can be had in all oak colours  
Les cages chêne se livrent en toutes teintes de chêne - Las cajas de roble se hacen en todos los colores

Zifferblatt - Dial - Cadran - Esfera 20,5 cm = 8 inches



Lauenburg I



78 x 33 cm = 30 3/4 x 13 inches

25/489 Eiche - Oak - Chêne - Roble  
25/490 Nußbaum - Walnut - Noyer  
Nogal

Lauenburg II



78 x 33 cm = 30 3/4 x 13 inches

25/491 Eiche - Oak - Chêne  
Roble

Lauenburg IV



78 x 33 cm = 30 3/4 x 13 inches

25/492 Eiche - Oak - Chêne - Roble  
25/493 Nußbaum - Walnut - Noyer  
Nogal

Waldgong - Bachgong - 1/4 Westminsterschlag  
Waldgong - Gong „Bim Bam“ - 1/4 Westminster chime  
Waldgong - Gong „Bim Bam“ - 1/4 Carillon Westminster  
Sonería sobre Waldgong - Gong „Bim Bam“ - 1/4 Carillon Westminster

Eichengehäuse in allen Eichenfarben lieferbar - Oak cases can be had in all oak colours  
Les cages chêne se livrent en toutes teintes de chêne - Las cajas de roble se hacen en todos los colores

Zifferblatt - Dial - Cadran - Esfera 20,5 cm = 8 inches



Oldenburg I



78 x 33 cm = 30 3/4 x 13 inches

25/494

Eiche - Oak - Chêne - Roble

Oldenburg II

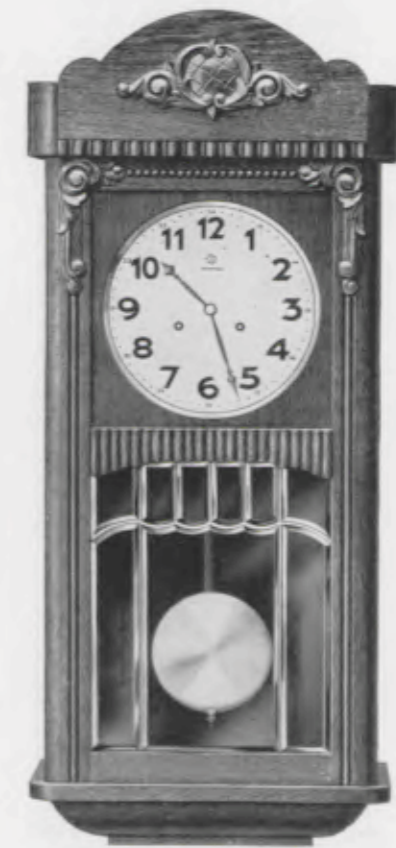

78 x 33 cm = 30 3/4 x 13 inches

25/495

Eiche - Oak - Chêne - Roble

Waldgong - Bachgong - 1/4 Westminsterschlag  
Waldgong - Gong „Bim Bam“ - 1/4 Westminster chime  
Waldgong - Gong „Bim Bam“ - 1/4 Carillon Westminster  
Sonería sobre Waldgong - Gong „Bim Bam“ - 1/4 Carillon Westminster

In allen Eichenfarben lieferbar - Can be had in all oak colours  
Peuvent être livrés en toutes teintes de chêne - Las cajas de roble se hacen en todos los colores

Zifferblatt - Dial - Cadran - Esfera 20,5 cm = 8 inches



Marburg I



78 x 33 cm = 30 3/4 x 13 inches

25/316 Mahagoni - Mahogany  
Acajou - Caoba

Marburg II

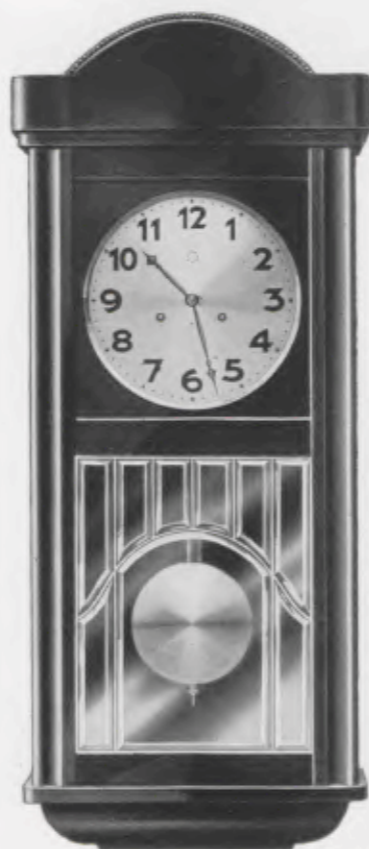

78 x 33 cm = 30 3/4 x 13 inches

25/317 Mahagoni - Mahogany  
Acajou - Caoba

Waldgong - Bachgong - 1/4 Westminsterschlag  
Waldgong - Gong „Bim Bam“ - 1/4 Westminster chime  
Waldgong - Gong „Bim Bam“ - 1/4 Carillon Westminster  
Soneria sobre Waldgong - Gong „Bim Bam“ - 1/4 Carillon Westminster

Zifferblatt - Dial - Cadran - Esfera 20,5 cm = 8 inches



GRUPPE 27

Aparte Wanduhren für die moderne Wohnung

Smart wall clocks for the modern home - Pendules art nouveau pour intérieurs modernes  
Relojes de pared especiales para la casa moderna



45 x 24 cm = 18 x 9 1/2 inches

27/16 Eiche - Oak - Chêne - Roble

27/17 Nußbaum poliert - Polished walnut - Noyer poli  
Nogal pulido

Goldblatt - Gilt dial - Cadran doré - Esfera dorada  
18 x 18 cm = 7 x 7 inches

Tonfeder - Plain strike - Ressort timbre - Sonería  
sobre bordón

Einstabgong - Rod gong - Gong tige - Gong tija • Bim Bam 3 Stäbe - Gong „Bim Bam“: 3 rods - 3 tiges - 3 varillas



52 x 26 cm = 20 1/2 x 10 1/4 inches

27/18 Eiche - Oak - Chêne - Roble

Silberblatt - Silver dial - Cadran argenté - Esfera  
plateada 20 x 20 cm = 8 x 8 inches



57,5 x 31,5 cm = 22 3/4 x 12 3/4 inches

27/27 Eiche mit Nußbaumtüre - Oak with walnut door  
Chêne avec porte en noyer - Roble con puerta en nogal

27/28 Nußbaum - Walnut - Noyer - Nogal

Silberzahlenreif, verchromte Zahlen und Zeiger  
Silvered figure-circle, chromium plated figures and hands  
Cercle à chiffres argenté, chiffres et aiguilles chromés  
Cercos de cifras plateado, cifras y agujas cromadas

Einstabgong - Rod gong - Gong tige - Gong tija • Bim Bam - Gong „Bim Bam“

Eichengehäuse in allen Eichenfarben lieferbar - Oak cases can be had in all oak colours  
Les cages chêne se livrent en toutes teintes de chêne - Las cajas de roble se hacen en todos los colores de roble



57,5 x 31,5 cm = 22 3/4 x 12 3/4 inches

27/29 Eiche - Oak - Chêne - Roble

Zifferblatt - Dial - Cadran - Esfera  
23 cm = 9 inches



50 x 30 cm = 19 3/4 x 11 1/4 inches



49,5 x 30 cm = 19 1/2 x 11 3/8 inches



48 x 29 cm = 18 7/8 x 11 3/8 inches

27/22 Zahlen - Figures - Chiffres  
Cifras  
27/23 Striche - Strokes - Barres  
Rayas

27/20 Zahlen - Figures - Chiffres  
Cifras  
27/21 Striche - Strokes - Barres  
Rayas

27/24 Zahlen - Figures - Chiffres  
Cifras  
27/25 Striche - Strokes - Barres  
Rayas

Kaukasisch Nußbaum poliert - Polished Caucasian walnut  
Noyer Caucasiens poli - Nogal Caúcaso pulido

Einstabgong - Rod gong - Gong tige - Gong tija  
Bim Bam 4 Stäbe - Gong „Bim Bam“: 4 rods - 4 tiges - 4 varillas



27/26

Kaukasisch Nußbaum poliert  
Polished Caucasian walnut  
Noyer Caucasiens poli  
Nogal Caúcaso pulido

Verchromte Zahlen und Zeiger  
Chromium plated figures and hands  
Chiffres et aiguilles chromés  
Cifras y agujas cromadas

28,5 x 35 cm = 11 1/4 x 13 3/4 inches

14 Tag Ankerschlagwerk mit Echappement - 14 day lever strike movement with escapement  
15 jours sonnerie à ancre avec échappement - 15 días sonería, escape á áncora

Bim Bam 3 Stäbe - Gong „Bim Bam“: 3 rods - 3 tiges - 3 varillas



GRUPPE 28

Dielenuhren

Hall clocks  
Horloges de parquet  
Relojes de recibidor

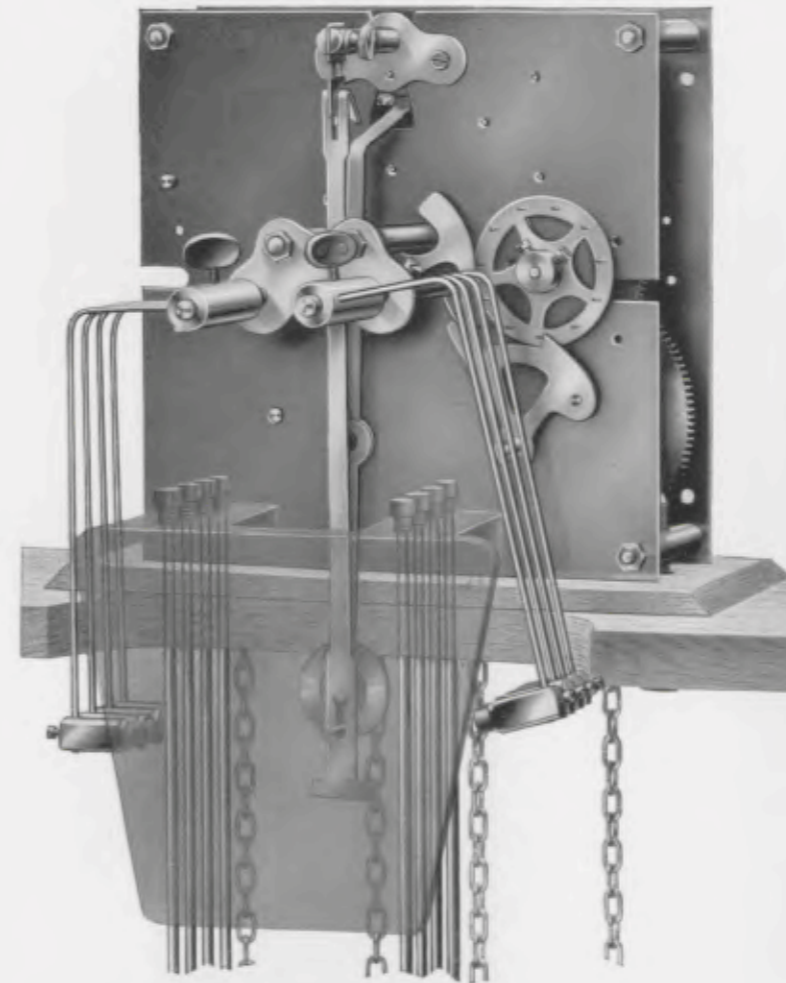

Werk - Movement - Mouvement  
Máquina  
No. 225

Platinen - Plates - Platines - Platinas  
15 x 15 cm = 6 x 6 inches

Schwinghamnergong, Bim Bam  
8 Stäbe

Gravity Hammers Gong, Bim Bam  
8 rods

Marteaux oscillateurs, Bim Bam  
8 tiges

Martillos oscilantes, Bim Bam  
8 varillas

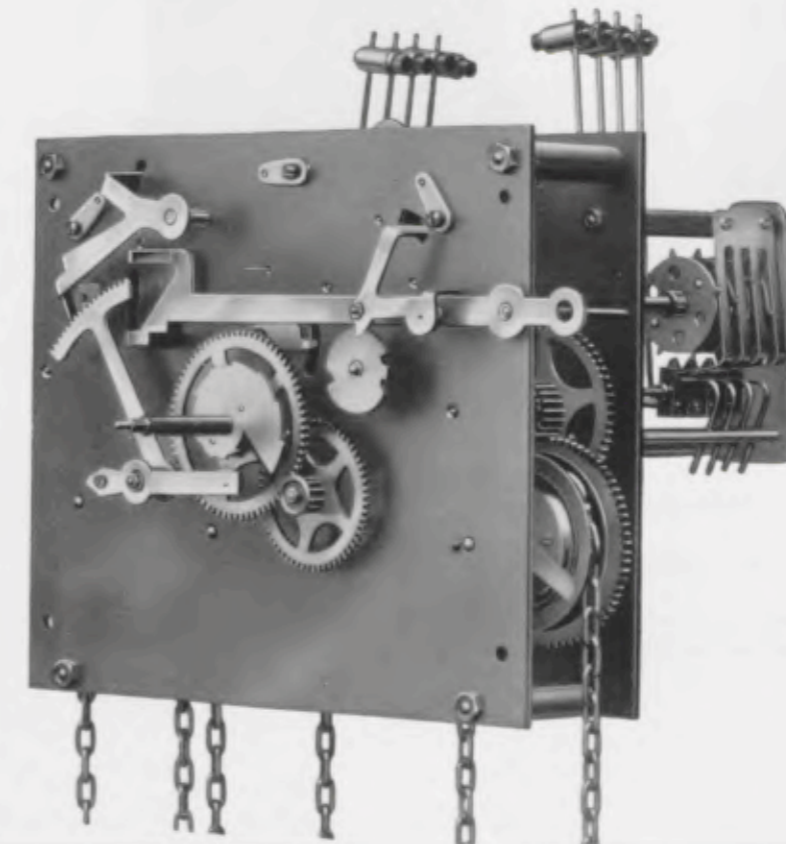

Werk - Movement - Mouvement  
Máquina

No. 70

Platinen - Plates - Platines - Platinas  
155 x 185 mm = 6 1/4 x 7 3/8 inches

8 Tag 1/4 Westminster-Rechenschlagwerk  
Dreilauf, 8 Hämmer - Massive Triebe  
Graham-Anker

1/4 Westminster Chime, 8 day rack strike,  
three trains, 8 hammers - Solid pinions -  
Graham escapement

Mouvement pour Horloges de Parquet  
1/4 Westminster, 8 jours sonnerie à râteau,  
trois trains, 8 marteaux - Pignons massifs  
Echappement Graham

Máquina para Relojes de vestibulo  
1/4 Westminster, 8 días sonería á sierra,  
tres pesas, 8 martillos - Piñones macizos  
Ancora sistema Graham

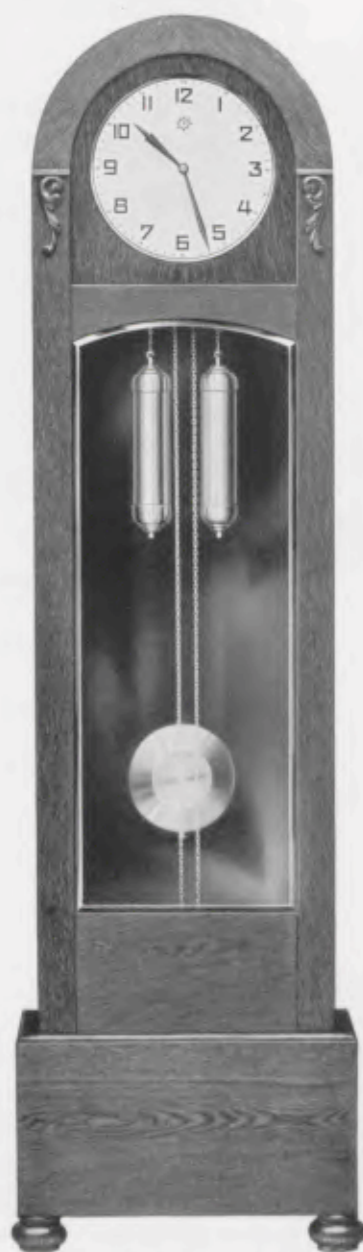

198 x 55 cm = 78 x 21 3/4 inches

28/155 Eiche - Oak - Chêne - Roble

Facetteglas - Bevelled glass - Verre biseauté - Vidrio biselado

Zifferblatt - Dial - Cadran - Esfera 29,5 cm = 12 inches

In allen Eichenfarben lieferbar - Can be had in all oak colours  
Se livrent en toutes teintes de chêne - Se hacen en todos los colores de roble

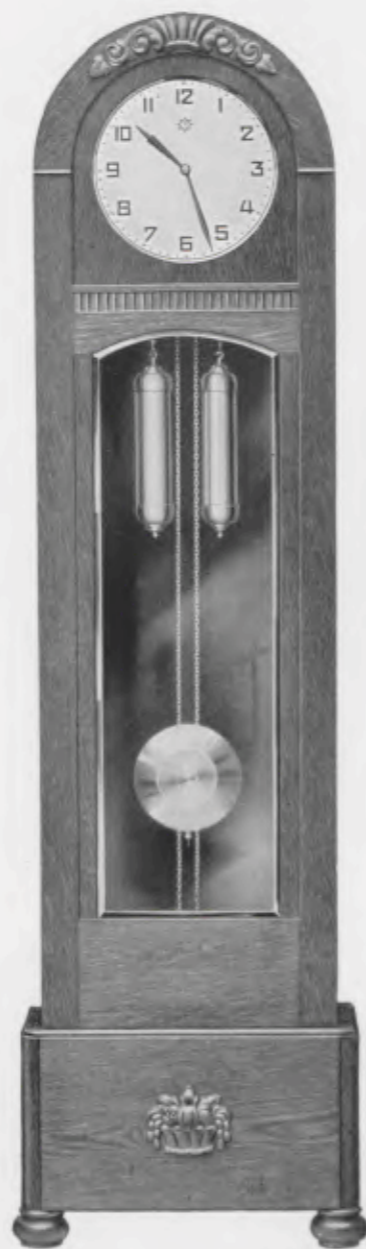

198 x 55 cm = 78 x 21 3/4 inches

28/156 Eiche - Oak - Chêne - Roble

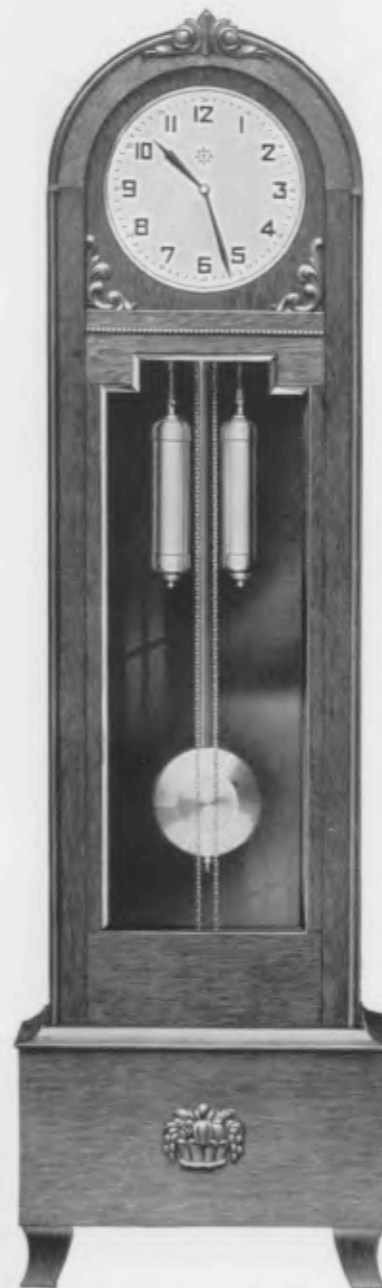

200 x 61 cm = 79 x 24 inches

28/158

Eiche - Oak - Chêne - Roble

Zifferblatt - Dial - Cadran - Esfera 33 cm = 13 inches

In allen Eichenfarben lieferbar - Can be had in all oak colours  
Se livrent en toutes teintes de chêne - Se hacen en todos los colores de roble



200 x 61 cm = 79 x 24 inches

28/159



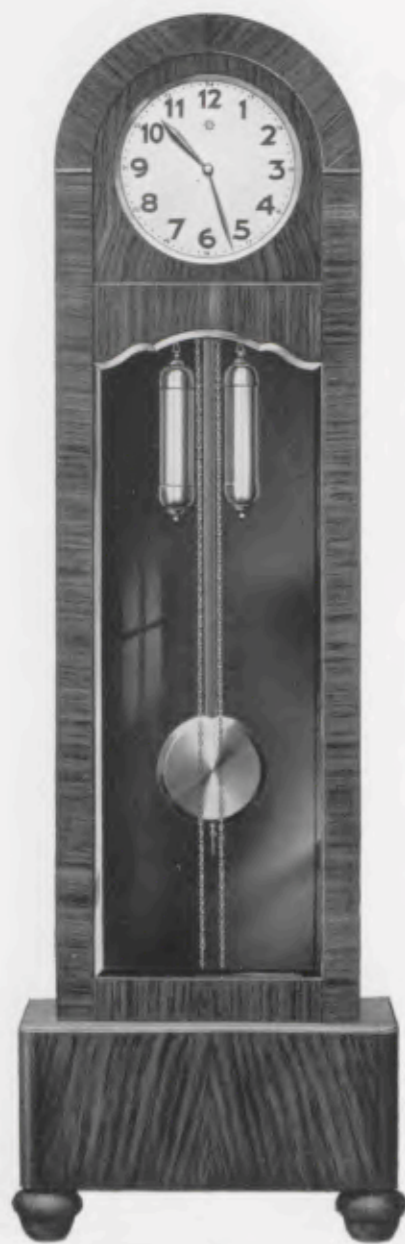

198 x 55 cm = 78 x 21 1/4 inches

**28/161** Nußbaum poliert  
Polished walnut - Noyer poli  
Nogal pulido

Zifferblatt - Dial - Cadran - Esfera  
29,5 cm = 12 inches

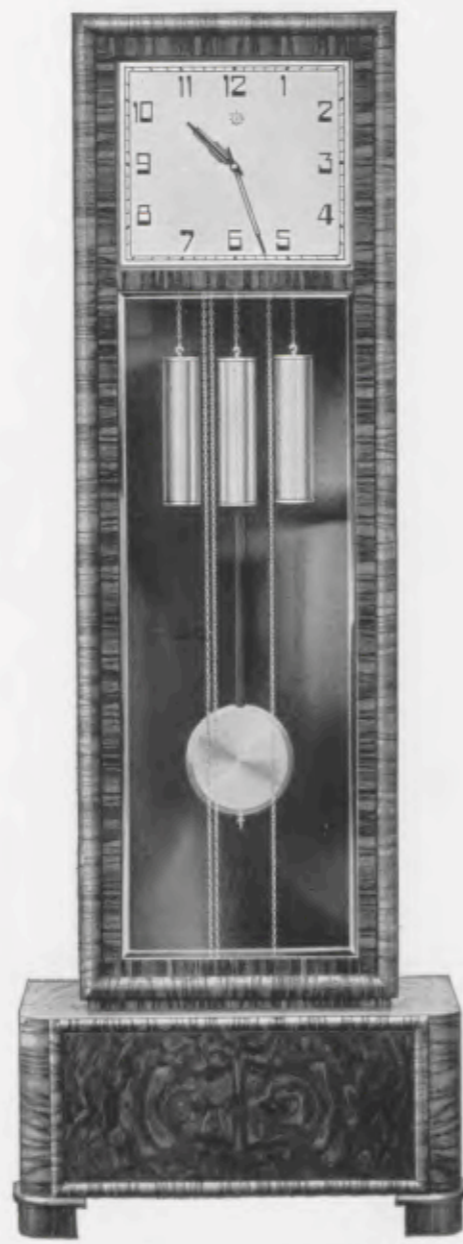

192 x 73 cm = 75 1/2 x 28 3/4 inches

**28/166** Kaukasisch Nußbaum poliert  
Polished Caucasian walnut  
Noyer Caucasien poli  
Nogal Caucaso pulido

Silberblatt mit blauen Zahlen  
Silver dial with blue figures  
Cadran argenté avec chiffres bleus  
Esfera plateada con cifras azules  
33 x 38 cm = 13 x 15 inches



