

Tunglhaus

1933



HAUPTKATALOG





UHRENFABRIKEN

Watch- and Clock Factories — Fabriques d'horlogerie — Fábricas de relojes

Gebrüder Junghans

A.-G.

SCHRAMBERG

Schwarzwald — Black-Forest — Forêt-Noire — Selva negra



Musterschutz

Unsere Muster sind in das Musterschutzregister für plastische Erzeugnisse eingetragen, also gesetzlich geschützt. Nachahmungen werden gerichtlich verfolgt.



Gruppen-Verzeichnis

Index of Groups * Index des groupes * Indice por grupos

Gruppe		Page	Gruppe		Page
4	Kleinste Qualitäts-Wecker Smallest highclass quality alarms Réveils miniature de qualité supérieure Despertadores miniatura de calidad superior	6	18	Bürouhren - Rundrahmehhren Dial clocks - Office clocks Céils de Bœuf - Pendules pour bureaux Relojes de pared y para despachos	63
5	Boudoir-Uhren Boudoir clocks Pendulettes de boudoir Relojes para tocador	9	19	Küchenuhren Kitchen clocks Pendules pour cuisine Relojes de cocina	77
6					
7	Miniatur-Wecker Miniature alarms Réveils miniature Despertadores de miniatura	25	23 24 25	Wanduhren Regulators Régulateurs Reguladores	85
8 9	Wecker in Metall- und Holzgehäusen Alarm clocks in metal and wooden cases Réveils en boîtes métal et bois Despertadores en cajas de metal y de madera	27			
		37			
10	Schreibtischuhren mit Ankergehwerk Writing table clocks lever time Pendulettes de bureau, à ancre Relojes para escritorio, á volante	38	27	Moderne Wanduhren Art regulators Régulateurs modernes Reguladores estilo moderno	97
12 14	Schiffsuhren . Autouhren Ship clocks . Motor Car clocks Horloges marines . Montres pour autos Relojes marina . Relojes para Automovil	40 41	54	Miniatur-Wecker Miniature alarms Réveils miniature Despertadores miniatura	22
17		43			
	Kaminuhren Mantle clocks Pendules de cheminée Relojes de sobremesa				



Nummern-Verzeichnis

Index of numbers * Index des numéros * Indice por números

Nº	Seite Page	Nº	Seite Page	Nº	Seite Page
4/17-18 RZ	6	7/195-196	25	14/23	41
4/291-292 RZ	6	7/323-324	25	14/121-122	41
4/295 RZ	6				
4/301-304 RZ	6	8/2	30	17/528	49
4/320-322 RZ	7	8/98	29	17/540	45
4/323 RZ	6	8/100	29	17/542	46
4/324-327 RZ	8	8/185-186	31	17/544-545	47
4/329 RZ	6	8/188	32	17/547	48
4/330	7	8/198-201	32	17/548	49
		8/221-222	32	17/549	50
5/190	12	8/223	33	17/554	54
5/193	12	8/226	33	17/569	48
5/197	12	8/234-236	29	17/575	59
5/199-200	12	8/242	30	17/577	56
5/209	18	8/246-247	29	17/596	59
5/215-218	11	8/266-269	31	17/597	60
5/219-220	15	8/270-273	33	17/598	60
5/223-224	15	8/276-277	30	17/611-614	51
5/225-226	16	8/299-300	36	17/615	52
5/227-228	17	8/316-319	34	17/631	54
5/229-230	13	8/320	35	17/632	53
5/237	18	8/321-322	33	17/633	54
5/238-239	10	8/326	34	17/634	56
5/240-241	13	8/328-329	35	17/635	52
5/242-243	14	8/333-335	30	17/636	53
				17/637	60
6/4	21	9/133-134	37	17/638-639	57
6/6	21			17/641	57
6/16	21			17/642	58
6/18	19	10/62	38	17/643	53
6/20	19	10/66-68	38	17/644	52
6/22	20	10/69-71	39	17/647	45
6/28	19			17/648	46
6/30	20	12/1-41	40	17/650-651	56
6/32	20			17/652-654	55



Nummern-Verzeichnis

Index of numbers * Index des numéros * Índice por números

N ^o	Seite Page	N ^o	Seite Page	N ^o	Seite Page
17/655	58	19/365-366	78	54/3	22
17/656	55	19/367-369	79	54/11	22
17/657	59	19/370-371	80	54/101-102	23
17/658	58	19/372-373	81	54/104-105	23
Konsole No. 1	61			54/107	23
		20/4-5	82	54/119	23
18/1-2	65	20/6-9	83	54/121-124	23
18/181-182	65			54/161	22
18/202-212	66	23/81, 83	85	54/244	24
18/216-235	67	23/88	85	54/246-251	24
18/248	73	23/90	86		
18/250-252	72	23/92	86	101/37 RZ	4
18/253-254	73			101/40 RZ	4
18/255-258	75	24/111-114	88	101/41 RZ	4
18/259-261	68	24/119	87	101/61 RZ	5
18/263-267	74	24/122-124	89	101/63 RZ	5
18/268-270	71	24/126-127	87	101/65 RZ	5
18/271-272	68			101/67 RZ	5
18/274	72	25/368	91	101/102 RZ	2
18/275	70	25/370, 372	92	101/106 RZ	2
18/276-280	69	25/466, 468	91	101/110-111 RZ	3
18/281-283	70	25/486-488	93	101/113-114 RZ	2
		25/491-492	94	101/115-116 RZ	3
		25/494	95		
19/318-319	79				
19/340	80	27/16-18	98		
19/342-347	78	27/20-26	99		
19/348-349	79	27/27-29	98		
19/350-351	81				
19/352-355	78	28/155-156	101		
19/357-359	80	28/158-159	102		
19/360	81	28/161	103		
19/361-363	80	28/166	103		
19/364	81				



Namen-Verzeichnis

Index of names * Index des noms * Índice por nombres

	Seite Page		Seite Page
Agnes	66	Lautlos	35
Altai	66	Lüneburg II	93
Azur	23	„ IV	93
Baby	29	Marine	40
Blaustern	31	Neu-Alemannia	6
Bravo	32	Neu-Blaustern	31
„ J	32	Neu-Bravetto	31
Darling	6	Neu-Bravo	33
Flotte	40	Neu-Bruck I	85
Globe	29	„ II	86
Gloria	23	„ III	86
Gossau I	88	Neu-Darling	6
„ II	88	Neu-Triumph	25
Halli I	33	Norden	85
„ II	33	Oldenburg I	95
Kalender	22	Primus II	22
Kassel I	91	Rotstern	31
„ II	91	Start	23
Kiel I	91	Stella	29
„ II	92	Turner	32
„ IV	92	Überlingen II	89
Lauenburg II	94	„ IV	89
„ IV	94		



Ihre „treueste“ Freundin, die Junghans Reiseuhr

Sie macht den Schluß, bevor der Koffer zugemacht wird, und den Anfang, wenn man ihn öffnet. Gleich darauf füllt sie dann wieder selbst das fremdeste Zimmer mit ihrem trauten Ticken. Man hat sie lieb. Manche Verabredung, mancher Zuganschluß würde verpaßt, wäre sie nicht, die immer wieder leise mahnend weckt, wann man es wünscht. — Ihre bewährten, flachen Klappformen sind unverändert. Nur die feinen Lederarten und kleinen Ausstattungseinheiten wandelten sich der Modeströmung entsprechend. So erfreuen sich besonders die neuen Vierecklunetten steigender Beliebtheit. Die niederen Preise entsprechen der Kaufkraft der heute noch reisefähigen Kreise.



GRUPPE 101

Reiseuhren

Travelling watches — Montres de voyage — Relojes para viaje



Durchmesser — Diameter — Diamètre
Diámetro 6,8 cm = 2 3/4 inches

Kalotte Werk J 66 (ohne Etui) für Etui-Ausschnitt 63 1/2 mm

Calotte movement J 66 (without leather case) for case-opening 63 1/2 mm

Calotte mouvement J 66 (sans écriin) pour ouverture d'écriin de 63 1/2 mm

Máquina completa J 66 (sin estuche) para abertura de estuche de 63 1/2 mm



10 x 10 cm = 4 x 4 inches

101/102 RZ Saffian-Schafleder, rotbraun — Brown sheep's skin, morocco grained — Mouton grain maroquin, brun-rouge — Badana tafilete, moreno

101/113 RZ Saffian-Schafleder, dunkelbraun — Brown sheep's skin, morocco grained — Mouton grain maroquin, brun — Badana tafilete, moreno
Ladenpreis.....RM. 20.—



10 x 10 cm = 4 x 4 inches

101/106 RZ Krokodilimitation, dunkelbraun — Brown crocodile, grained — Crocodile grain, brun
Piel de cocodrilo imitación, moreno

Ladenpreis.....RM. 21.50



10 x 10 cm = 4 x 4 inches

101/114 RZ Echt Saffian, grau — Morocco grey
Maroquin gris — Cabra gris

Ladenpreis.....RM. 21.50

1 Tag Weckerwerk No. J 66 — 1 day alarm movement No. J 66

30 heures réveil mouvement No. J 66 — 30 horas despertador máquina No. J 66

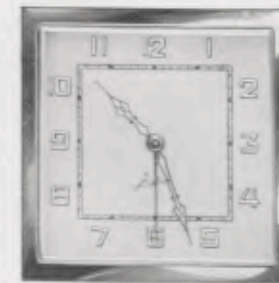

7,7 x 7,7 cm = 3 x 3 inches

Kalotte viereckig, Werk J 66 (ohne Etui) für Etui-Ausschnitt 61 x 61 mm

Square calotte, movement J 66 (without leather case) for case-opening 61 x 61 mm

Calotte carrée, mouvement J 66 (sans écriin) pour ouverture d'écriin de 61 x 61 mm

Máquina completa J 66 (sin estuche) para abertura de estuche de 61 x 61 mm



10 x 10 cm = 4 x 4 inches

101/110 RZ Saffian-Schafleder, braun
Brown sheep's skin, morocco grained
Mouton grain maroquin, brun
Badana tafilete, moreno

Ladenpreis.....RM. 21.50

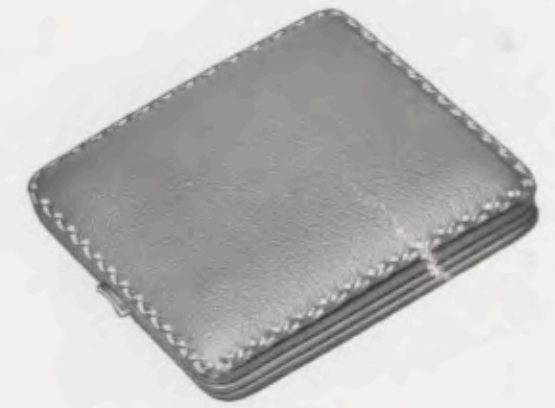

10 x 10 cm = 4 x 4 inches

101/111 RZ Saffian-Schafleder, braun
Brown sheep's skin, morocco grained
Mouton grain maroquin, brun
Badana tafilete, moreno

Ladenpreis.....RM. 22.50

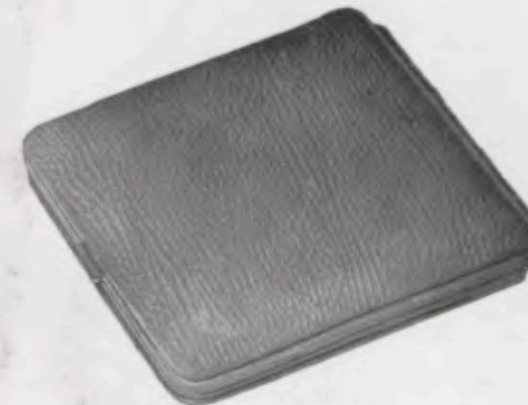

10 x 10 cm = 4 x 4 inches

101/115 RZ Tapir — Tapir — Tapiro

Ladenpreis.....RM. 21.50

Viereck-Silberblatt, verchromter Rahmen — Square silver dial, chromium plated bezel
Cadran carré argenté, lunette chromée — Esfera cuadrada plateada, bisel cromado

1 Tag Weckerwerk No. J 66 — 1 day alarm movement No. J 66

30 heures réveil mouvement No. J 66 — 30 horas despertador máquina No. J 66

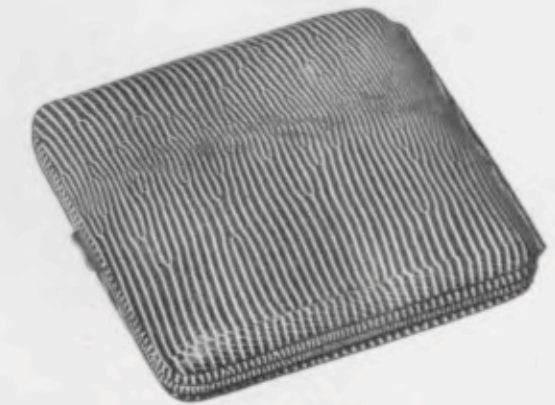

10 x 10 cm = 4 x 4 inches

101/116 RZ Eidechse — Lizard-skin
Lézard — Lagarto

Ladenpreis.....RM. 21.50



Durchmesser - Diameter - Diamètre
Diámetro 5,5 cm = 2 1/4 inches

Kleine Kalotte, Werk J 36 mit 7 Steinen für Etui-Ausschnitt 53 mm
 Große Kalotte, Werk J 36 mit 7 Steinen für Etui-Ausschnitt 63 1/2 mm
 Small calotte, movement J 36 with 7 jewels for case-opening 53 mm
 Large calotte, movement J 36 with 7 jewels for case-opening 63 1/2 mm
 Petite calotte, mouvement J 36 à 7 rubis pour ouverture d'écrin de 53 mm
 Grande calotte, mouvement J 36 à 7 rubis pour ouverture d'écrin de 63 1/2 mm
 Máquina completa pequeña J 36 á 7 rubis para abertura de estuche de 53 mm
 Máquina completa grande J 36 á 7 rubis para abertura de estuche de 63 1/2 mm



9 x 9 cm = 3 1/2 x 3 1/2 inches

101/37 RZ

Schwarz Saffian - Black morocco
 Maroquin noir - Cabra negra



9 x 9 cm = 3 1/2 x 3 1/2 inches

101/40 RZ

Echt Saffian, cochenillerot - Cochineal morocco
 Maroquin cochenille - Cabra cochenilla



9 x 9 cm = 3 1/2 x 3 1/2 inches

101/41 RZ

Braun Carara matt - Brown carara mat
 Carara brun mat - Carara mate, moreno

1 Tag Weckerwerk No. J 36 mit 7 Steinen - 1 day alarm movement No. J 36 with 7 jewels
 30 heures réveil mouvement No. J 36 avec 7 rubis - Despertador, 30 horas cuerda, máquina
 No. J 36 con 7 rubis



9 x 9 cm = 3 1/2 x 3 1/2 inches

101/61 RZ

Schattenrindleder hellbraun - Cowhide brown
 Cuir de bœuf brun avec ombres
 Cuero de buey moreno con sombras



9 x 9 cm = 3 1/2 x 3 1/2 inches

101/63 RZ

Saffian, rotbraun - Morocco brown
 Maroquin brun - Cabra moreno



11 x 9 cm = 4 1/4 x 3 1/2 inches

101/65 RZ

Echt Saffian, blau - Morocco blue
 Maroquin bleu - Cabra azul



8 x 10 cm = 3 1/4 x 4 inches

101/67 RZ

Saffian-Schaffleder, braun - Brown sheep's skin, morocco grained - Mouton grain maroquin, brun - Badana tafilete, moreno

1 Tag Weckerwerk No. J 36 mit 7 Steinen - 1 day alarm movement No. J 36 with 7 jewels - 30 heures réveil mouvement No. J 36 avec 7 rubis - Despertador, 30 horas cuerda, máquina No. J 36 con 7 rubis



GRUPPE 4

Kleinste Qualitäts-Wecker - Ankerwerke mit Taschenuhrhemmung

Smallest highclass quality alarms - Lever-movement with watch escapement

Réveils miniature de qualité supérieure - Mouvement à ancre avec échappement de montre de poche

Despertadores miniatura de calidad superior - Máquina á áncora con escape de reloj de bolsillo

Neu-Alemannia



6 cm = 2 1/4 inches

4/291 RZ Rotbraun - Claret coloured - Brun-rouge

Rojo oscuro

4/292 RZ Blau - Blue - Bleu - Azul

LadenpreisRM. 9.50

4/295 RZ Verchromt, Silberblatt - Chromium plated, silver dial - Chromé, cadran argenté

Cromado, esfera plateada

LadenpreisRM. 12.—

Bügel-Absteller - The alarm is stopped by pushing the handle down
Arrêtage du réveil par la poignée - El despertador se para doblando la manija

Neu-Alemannia



6 cm = 2 1/4 inches

4/301 RZ Rotbraun - Claret coloured - Brun-rouge

Rojo oscuro

4/302 RZ Blau - Blue - Bleu - Azul

LadenpreisRM. 10.50

4/303 RZ Verchromt, Silberblatt - Chromium plated, silver dial - Chromé, cadran argenté

Cromado, esfera plateada

LadenpreisRM. 12.—

Neu-Alemannia



6 cm = 2 1/4 inches

4/304 RZ Verchromt, Silberblatt - Chromium plated, silver dial - Chromé, cadran argenté

Cromado, esfera plateada

LadenpreisRM. 12.—

Bügel-Absteller - The alarm is stopped by pushing the handle down
Arrêtage du réveil par la poignée - El despertador se para doblando la manija

Darling



10 cm = 4 inches

4/17 RZ Versilbert - Silvered - Argenté - Plateado

4/18 RZ Vergoldet - Gilt - Doré - Dorado

1 Tag Weckerwerk No. J 63 - 1 day alarm movement No. J 63
30 heures réveil mouvement No. J 63 - 30 horas despertador máquina No. J 63

Neu-Darling



8 x 7,5 cm = 3 1/4 x 3 inches

4/329 RZ

Verchromt, Silberblatt - Chromium plated, silver dial - Chromé, cadran argenté - Cromado, esfera plateada

1 Tag Weckerwerk No. 79 - 1 day alarm movement
No. 79 - 30 heures réveil mouvement No. 79 - 30 horas despertador, máquina No. 79

1 Tag Weckerwerk No. J 66 - 1 day alarm movement
No. J 66 - 30 heures réveil mouvement No. J 66
30 horas despertador, máquina No. J 66

Silber-, Gold- und Kartonblatt mit Radium-Ausstattung (RZ) - Silvered, gilt and cardboard dial with luminous figures (RZ)
Cadran argenté, doré et cadran carton avec chiffres lumineux Radium (RZ)
Esfera plateada, dorada y esfera de cartón con cifras luminosas Radium (RZ)



7 x 11 cm = 2 3/4 x 4 1/4 inches

4/323 Z RZ Zahlen - Figures - Chiffres - Cifras

4/323 S RZ Striche - Strokes - Barres - Rayas

LadenpreisRM. 15.—



1 Tag Weckerwerk No. J 66 - 1 day alarm movement No. J 66
30 heures réveil mouvement No. J 66 - 30 horas despertador, máquina No. J 66



7 cm = 2 3/4 inches

4/320 Z RZ Zahlen - Figures - Chiffres - Cifras

4/320 S RZ Striche - Strokes - Barres - Rayas



7 cm = 2 3/4 inches

4/322 Z RZ Zahlen - Figures - Chiffres - Cifras

4/322 S RZ Striche - Strokes - Barres - Rayas

Silberblatt - Silver dial - Cadran argenté - Esfera plateada



7 cm = 2 3/4 inches

4/321 Z RZ Zahlen - Figures - Chiffres - Cifras

4/321 S RZ Striche - Strokes - Barres - Rayas

Silberblatt - Silver dial - Cadran argenté - Esfera plateada



7 cm = 2 3/4 inches

4/330 Etui braun Carara-Imitation
Brown carara imitation case



7,5 cm = 3 inches

4/330 Ecrin brun, imitation carara
Estuche de carara imitación moreno



1 Tag Weckerwerk No. J 63 - 1 day alarm movement No. J 63
 30 heures réveil mouvement No. J 63 - 30 horas despertador, máquina No. J 63



8 x 15 cm = 3 1/8 x 6 inches

4/324 RZ

Kaukasisch Nußbaum poliert, Chromfüße
 Polished Caucasian walnut, chromium plated feet
 Noyer Caucasiens poli, pieds chromés
 Nogal Caúcaso pulido, pies cromados



7 x 12 cm = 2 3/4 x 4 3/4 inches

4/325 RZ

Kaukasisch Nußbaum mit Nußbaummaser poliert,
 Chromfüße
 Polished Caucasian walnut with bur walnut, chromium
 plated feet
 Noyer Caucasiens avec loupe de noyer poli, pieds chromés
 Nogal Caúcaso con raiz de nogal pulido, pies cromados



8 x 13 cm = 3 1/8 x 5 1/8 inches

4/326 RZ

Schleiflack schwarz, Kugeln und Füße verchromt
 Varnished black dull, balls and feet chromium plated
 Peinture noire laquée dépolie, boules et pieds chromés
 Barniz pulido mate, bolas y pies cromados



9 x 13 cm = 3 1/2 x 5 1/8 inches

4/327 RZ

Schleiflack schwarz, Träger und Kugeln verchromt
 Varnished black dull with chromium plated ornaments
 Peinture noire laquée dépolie, support et boules
 chromés
 Barniz pulido mate, portador y bolas cromados

Chromlünette, Silberblatt - Chromium plated bezel, silver dial
 Lunette chromée, cadran argenté - Bisel cromado, esfera plateada



Chromrahmen-Uhren, die Uhrenliebblinge unserer Zeit!

Überall, wo eine Uhr nicht nur Uhr sein soll, sondern darüber hinaus einem bevorzugten Platz im Zimmer eine persönliche Note verleihen soll, wünscht man sich eine Junghans-Chromrahmen-Uhr hin. So findet man sie immer häufiger auf dem Schreibtisch des Herrn, wie auf dem Frisiertisch der Dame, auf kleinen Gebrauchstischchen, ebenso wie etwa auf einer durch sie betonten Ecke des Büfetts. Das Geheimnis ihrer Anpassungsfähigkeit ist der stets reizvolle Kontrast des Chromrahmens in seinen mannigfachen Variationen mit den verschiedenen Edelhölzern der Möbel. Modelle mit Zifferblättern, die zur Blickrichtung entsprechend verstellt werden können, sind besonders zweckmäßig und beliebt. Die Preise der Junghans-Chromrahmen-Uhren haben sich der unterschiedlichen Kaufkraft bemerkenswert elastisch angepaßt.



GRUPPE 5

Feine Boudoir-Uhren mit Qualitätswerk

Highclass quality boudoir clocks - Pendulettes de boudoir, qualité supérieure
Relojes para tocador de calidad superior



Platinen - Plates - Platinas - Platinas 52,5 mm = 2 1/4 inches

No. J 66

1 Tag flaches Weckerwerk, abnehmbare Anker- und Balancebrücke, herausnehmbare Federhäuser
1 day alarm, removable balance and lever bridges, interchangeable spring barrel
Mouvement, 30 heures réveil, pont d'ancre et d'échappement démontable, barillet démontable
Despertador, 30 horas cuerda, puentes para el áncora y volante á desmontar, barillete intercambiable



Platinen - Plates - Platinas - Platinas 50 x 42 mm = 2 x 1 1/4 inches

No. J 44

Gut regulierendes 8 Tag Ankergehwerk
Well regulated 8 day lever time movement
Mouvement 8 jours simple, échappement à ancre, avec bon réglage
Máquina 8 días cuerda, escape á áncora. Bien ajustado



6,5 x 6,5 cm = 2 1/2 x 2 1/2 inches

5/238 Z RZ

1 Tag flaches Weckerwerk - 1 day alarm - 30 heures réveil - Despertador, 30 horas cuerda
Ladenpreis RM. 12.—

5/239 Z

8 Tag Ankergehwerk - 8 day lever time movement
Mouvement 8 jours simple, échappement à ancre - Máquina 8 días cuerda, escape á áncora
Ladenpreis RM. 13.—

Verchromt poliert, Silberblatt - Chromium plated, polished, silver dial
Chromé, poli, cadran argenté - Cromado, pulido, esfera plateada



6,5 x 6,5 cm = 2 1/2 x 2 1/2 inches

5/238 S RZ

5/239 S



8 x 8 cm = 3 1/4 x 3 1/4 inches

5/215 Z RZ

1 Tag flaches Weckerwerk - 1 day alarm
30 heures réveil - Despertador, 30 horas cuerda
Ladenpreis RM. 12.50

5/216 Z

8 Tag Ankergehwerk - 8 day lever time movement
Mouvement 8 jours simple, échappement à ancre - Máquina 8 días cuerda, escape á áncora
Ladenpreis RM. 13.50



8 x 8 cm = 3 1/4 x 3 1/4 inches

5/215 S RZ

5/216 S



10 x 10 cm = 4 x 4 inches

5/217 Z RZ

1 Tag flaches Weckerwerk - 1 day alarm
30 heures réveil - Despertador, 30 horas cuerda
Ladenpreis RM. 13.50

5/218 Z

8 Tag Ankergehwerk - 8 day lever time movement
Mouvement 8 jours simple, échappement à ancre - Máquina 8 días cuerda, escape á áncora
Ladenpreis RM. 15.—



10 x 10 cm = 4 x 4 inches

5/217 S RZ

5/218 S

Verchromt poliert, Silberblatt - Chromium plated, polished, silver dial
Chromé, poli, cadran argenté - Cromado, pulido, esfera plateada



7,5 x 11 cm = 3 x 4 1/4 inches

5/193 1 Tag Weckerwerk - 1 day alarm - 30 heures réveil
Despertador, 30 horas cuerda

5/199 8 Tag Ankergehwerk - 8 day lever time movement - Mouvement 8 jours simple, échappement à ancre - Máquina 8 días cuerda, escape á áncora

Verchromt poliert, Silberblatt
Chromium plated, polished, silver dial
Chromé, poli, cadran argenté
Cromado, pulido, esfera plateada



10 x 10 cm = 4 x 4 inches

5/197 Verchromt poliert, Silberblatt, weiß polierte Striche
Chromium plated polished, silver dial, polished white strokes

Chromé poli, cadran argenté, barres blanches polies
Cromado pulido, esfera plateada, rayas blancas pulidas

8 Tag Ankergehwerk
8 day lever time movement
8 jours simple, échappement à ancre
Máquina 8 días cuerda, escape á áncora

Ladenpreis RM. 25.—



13 x 13 cm = 5 1/4 x 5 1/4 inches

5/190 Verchromt poliert, Silberblatt - Chromium plated, polished, silver dial - Chromé, poli, cadran argenté - Cromado, pulido, esfera plateada



14 x 14 cm = 5 1/2 x 5 1/2 inches

5/200 Silberblatt, blau polierte Striche - Silver dial, polished blue strokes - Cadran argenté, barres bleues polies - Esfera plateada, rayas azules pulidas

Verchromt poliert - Chromium plated, polished
Chromé, poli - Cromado, pulido

Ladenpreis RM. 35.—

8 Tag Ankergehwerk - 8 day lever time movement
8 jours simple, échappement à ancre - Máquina 8 días cuerda, escape á áncora



7,5 x 13 cm = 3 x 5 1/4 inches

Rahmen - Frame - Cadre - Marco 6,5 x 6,5 cm = 2 1/2 x 2 1/2 inches

5/240 Z RZ

1 Tag flaches Weckerwerk - 1 day alarm - 30 heures réveil - Despertador, 30 horas cuerda
Ladenpreis RM. 15.—

5/241 Z

8 Tag Ankergehwerk - 8 day lever time movement - Mouvement 8 jours simple, échappement à ancre
Máquina 8 días cuerda, escape á áncora

Ladenpreis RM. 16.50

Verchromt poliert, Silberblatt, drehbarer Rahmen

Chromium plated, polished, silver dial, movable frame - Chromé, poli, cadran argenté, cadre mobile
Cromado, pulido, esfera plateada, marquito movable



7,5 x 13 cm = 3 x 5 1/4 inches

5/240 S RZ

5/241 S



9,5 x 11 cm = 3 3/4 x 4 1/4 inches

Rahmen - Frame - Cadre - Marco 8 x 8 cm = 3 1/4 x 3 1/4 inches

5/229 Z RZ

1 Tag flaches Weckerwerk - 1 day alarm - 30 heures réveil - Despertador, 30 horas cuerda
Ladenpreis RM. 15.—

5/230 Z

8 Tag Ankergehwerk - 8 day lever time movement - Mouvement 8 jours simple, échappement à ancre
Máquina 8 días cuerda, escape á áncora

Ladenpreis RM. 16.50

Verchromt poliert, Silberblatt - Chromium plated, polished, silver dial
Chromé, poli, cadran argenté - Cromado, pulido, esfera plateada



9,5 x 11 cm = 3 3/4 x 4 1/4 inches

5/229 S RZ

5/230 S



11 x 19,5 cm = 4 1/4 x 7 1/2 inches

Rahmen - Frame - Cadre - Marco 10 x 10 cm = 4 x 4 inches

- 5/242 Z RZ 1 Tag flaches Weckerwerk - 1 day alarm
30 heures réveil - Despertador, 30 horas cuerda
Ladenpreis RM. 17.50
- 5/243 Z 8 Tag Ankergehwerk - 8 day lever time movement
Mouvement 8 jours simple, échappement à ancre
Máquina 8 días cuerda, escape á áncora
Ladenpreis RM. 20.—



11 x 19,5 cm = 4 1/4 x 7 1/2 inches

Rahmen - Frame - Cadre - Marco 10 x 10 cm = 4 x 4 inches

- 5/242 S RZ 1 Tag flaches Weckerwerk - 1 day alarm
30 heures réveil - Despertador, 30 horas cuerda
Ladenpreis RM. 17.50
- 5/243 S 8 Tag Ankergehwerk - 8 day lever time movement
Mouvement 8 jours simple, échappement à ancre
Máquina 8 días cuerda, escape á áncora
Ladenpreis RM. 20.—

Verchromt poliert, Silberblatt, drehbarer Rahmen
Chromium plated, polished, silver dial, movable frame
Chromé, poli, cadran argenté, cadre mobile
Cromado, pulido, esfera plateada, marquito movable



9 x 16 cm = 3 1/2 x 6 1/4 inches

- 5/219 Z RZ 1 Tag Weckerwerk - 1 day alarm
30 heures réveil - Despertador, 30 horas cuerda
Ladenpreis RM. 24.—
- 5/220 Z 8 Tag Ankergehwerk - 8 day lever time movement
Mouvement 8 jours simple, échappement à ancre
Máquina 8 días cuerda, escape á áncora
Ladenpreis RM. 26.—

Verchromt poliert, Silberblatt, drehbarer Rahmen
Chromium plated, polished, silver dial, movable frame
Chromé, poli, cadran argenté, cadre mobile
Cromado, pulido, esfera plateada, marquito movable



9 x 16 cm = 3 1/2 x 6 1/4 inches

- 5/220 S 8 Tag Ankergehwerk - 8 day lever time movement
Mouvement 8 jours simple, échappement à ancre
Máquina 8 días cuerda, escape á áncora
Ladenpreis RM. 26.—



9 x 14 cm = 3 1/2 x 5 1/2 inches

- 5/223 Z RZ 1 Tag Weckerwerk - 1 day alarm
30 heures réveil - Despertador, 30 horas cuerda
Ladenpreis RM. 30.—
- 5/224 Z 8 Tag Ankergehwerk - 8 day lever time movement
Mouvement 8 jours simple, échappement à ancre
Máquina 8 días cuerda, escape á áncora
Ladenpreis RM. 32.—

Verchromt poliert mit schwarzer Kristallglaseinlage, Silberblatt, drehbarer Rahmen
Chromium plated, polished, with black plate-glass inset, silver dial, movable frame
Chromé, poli, avec applique en verre noire, cadre mobile
Cromado, pulido, con vidrio negro, esfera plateada, marquito movable



9 x 14 cm = 3 1/2 x 5 1/2 inches

- 5/224 S 8 Tag Ankergehwerk - 8 day lever time movement
Mouvement 8 jours simple, échappement à ancre
Máquina 8 días cuerda, escape á áncora
Ladenpreis RM. 32.—



9 x 20 cm = 3 1/2 x 8 inches

- 5/225 Z RZ** 1 Tag Wecker - 1 day alarm
 30 heures réveil - Despertador, 30 horas cuerda
 LadenpreisRM. 33.—
- 5/226 Z** 8 Tag Ankergehwerk - 8 day lever time movement
 Mouvement 8 jours simple, échappement à ancre
 Máquina 8 días cuerda, escape á âncora
 LadenpreisRM. 35.—



9 x 20 cm = 3 1/2 x 8 inches

- 5/225 S RZ** 1 Tag Wecker - 1 day alarm
 30 heures réveil - Despertador, 30 horas cuerda
 LadenpreisRM. 33.—
- 5/226 S** 8 Tag Ankergehwerk - 8 day lever time movement
 Mouvement 8 jours simple, échappement à ancre
 Máquina 8 días cuerda, escape á âncora
 LadenpreisRM. 35.—

Verchromt poliert, Silberblatt, drehbarer Rahmen - Chromium plated, polished, silver dial, movable frame
 Chromé, poli, cadran argenté, cadre mobile - Cromado, pulido, esfera plateada, marquito movable



9 x 25 cm = 3 1/2 x 9 3/4 inches

- 5/227 Z RZ** 1 Tag Wecker - 1 day alarm
 30 heures réveil - Despertador, 30 horas cuerda
 LadenpreisRM. 34.—
- 5/228 Z** 8 Tag Ankergehwerk - 8 day lever time movement
 Mouvement 8 jours simple, échappement à ancre
 Máquina 8 días cuerda, escape á âncora
 LadenpreisRM. 36.—



9 x 25 cm = 3 1/2 x 9 3/4 inches

- 5/227 S RZ** 1 Tag Wecker - 1 day alarm
 30 heures réveil - Despertador, 30 horas cuerda
 LadenpreisRM. 34.—
- 5/228 S** 8 Tag Ankergehwerk - 8 day lever time movement
 Mouvement 8 jours simple, échappement à ancre
 Máquina 8 días cuerda, escape á âncora
 LadenpreisRM. 36.—

Verchromt poliert mit schwarzer Kristallglas-Einlage, Silberblatt
 Chromium plated, polished, with black plate-glass inset, silver dial
 Chromé, poli, avec applique en verre noire, cadran argenté
 Cromado, pulido, con vidrio negro, esfera plateada



17 x 15,5 cm = 6 7/8 x 6 1/8 inches

5/209 Verchromt poliert, Silberblatt mit weiß polierten Zahlen
 Chromium plated, polished, silver dial with white polished figures
 Chromé, poli, cadran argenté avec chiffres blancs, polis
 Cromado, pulido, esfera plateada con cifras blancas, pulidas



20 x 15,5 cm = 7 7/8 x 6 1/8 inches

5/237 Verchromt mit kaukasisch Nußbaum poliert, Silberblatt
 Chromium plated with polished Caucasian walnut, silver dial
 Chromé avec noyer Caucasiens poli, cadran argenté
 Cromado con nogal Caucáso pulido, esfera plateada

8 Tag Ankergehwerk - 8 day lever time movement
 Mouvement 8 jours simple, échappement à ancre - Máquina, 8 días cuerda, escape á áncora



GRUPPE 6

Boudoir-Uhren mit einfachem Ankerwerk
 Boudoir clocks - Pendulettes de boudoir - Relojes para tocador

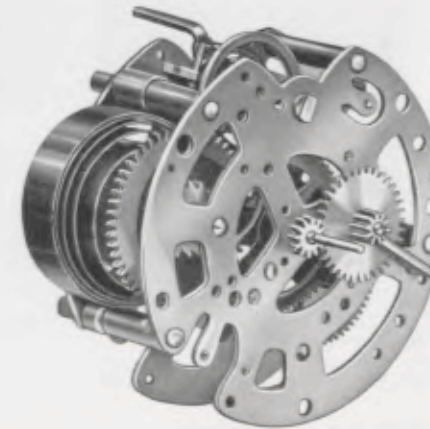

Platinen - Plates - Platines - Platinas
 54 mm = 2 1/4 inches

No. 59

1 Tag Gehwerk - 1 day time
 30 heures simple - 30 horas cuerda

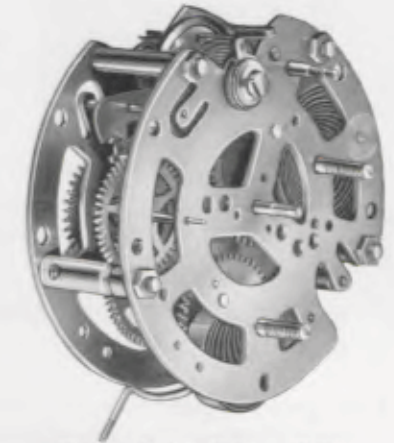

Platinen - Plates - Platines - Platinas
 54 mm = 2 1/4 inches

No. 60

1 Tag Wecker - 1 day alarm
 30 heures réveil - 30 horas despertador



6,5 x 6,5 cm = 2 1/2 x 2 1/2 inches

6/28 1 Tag Wecker
 1 day alarm
 30 heures réveil
 30 horas despertador



8 x 8 cm = 3 1/8 x 3 1/8 inches

6/18 1 Tag Wecker - 1 day alarm
 30 heures réveil - 30 horas despertador



10 x 10 cm = 4 x 4 inches

6/20 1 Tag Wecker - 1 day alarm
 30 heures réveil - 30 horas despertador

Verchromt, Silberblatt - Chromium plated, silver dial - Chromé, cadran argenté - Cromado, esfera plateada



9,5 x 11 cm = 3 7/8 x 4 1/4 inches



9,5 x 12 cm = 3 7/8 x 4 7/8 inches

Rahmen - Frame - Cadre - Marco

8 x 8 cm = 3 1/8 x 3 1/8 inches

8 x 8 cm = 3 1/8 x 3 1/8 inches

6/22 1 Tag Wecker - 1 day alarm
30 heures réveil - 30 horas despertador

Verchromt, Silberblatt
Chromium plated, silver dial
Chromé, cadran argenté
Cromado, esfera plateada

6/30 1 Tag Wecker - 1 day alarm
30 heures réveil - 30 horas despertador

Verchromt, Silberblatt, drehbarer Rahmen
Chromium plated, silver dial, movable frame
Chromé, cadran argenté, cadre mobile
Cromado, esfera plateada, marquito movable



11,5 x 15 cm = 4 1/2 x 6 inches

Rahmen - Frame - Cadre - Marco 10 x 10 cm = 4 x 4 inches

6/32 Z Zahlen - Figures - Chiffres - Cifras

6/32 S Striche - Strokes - Barres - Rayas

1 Tag Wecker - 1 day alarm
30 heures réveil - 30 horas despertador

Verchromt, Silberblatt, drehbarer Rahmen - Chromium plated, silver dial, movable frame
Chromé, cadran argenté, cadre mobile - Cromado, esfera plateada, marquito movable



13 x 13 cm = 5 1/4 x 5 1/4 inches



12,5 x 15,5 cm = 4 7/8 x 6 inches

6/4 1 Tag Wecker - 1 day alarm
30 heures réveil - 30 horas despertador

6/6 1 Tag Wecker - 1 day alarm
30 heures réveil - 30 horas despertador

Chromrahmen, Silberblatt - Chromium plated frame, silver dial
Cadre chromé, cadran argenté - Marquito cromado, esfera plateada

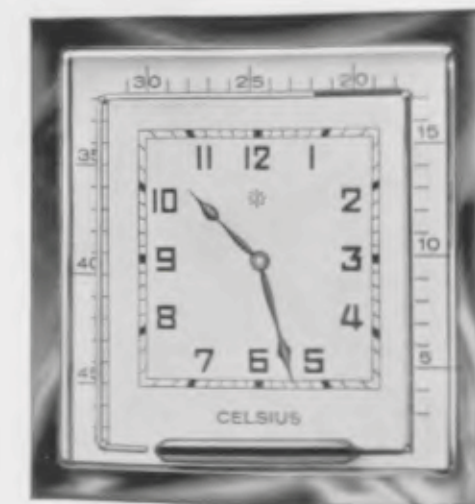

12 x 13 cm = 5 1/4 x 5 1/4 inches

6/16 1 Tag Wecker - 1 day alarm - 30 heures réveil - 30 horas despertador

Mit Celsius und Fahrenheit lieferbar - Can be had with Celsius and Fahrenheit
Livvable en Celsius et Fahrenheit - Se hace en Celsius y Fahrenheit

Chromrahmen, Silberblatt mit Thermometer - Chromium plated frame, silver dial with thermometer
Cadre chromé, cadran argenté avec thermomètre - Marquito cromado, esfera plateada con termómetro



GRUPPE 54

Miniatur-Wecker mit Hohltriebwerk ohne Federhaus

Miniature-Alarms, movement with lantern pinions, without spring barrel - Réveils miniature, mouvement avec pignons lanternes, sans barillet - Despertadores miniatura, máquina con piñones de linterna, sin barillete

Primus II



10,5 cm = 4 1/8 inches

54/3

1 Tag Wecker - 1 day alarm - 30 heures réveil - 30 horas despertador

Zinkgehäuse vernickelt, weiß Kartonblatt - Zinc case nickelled, white cardboard dial
Boîte zinc nickelé, cadran carton blanc - Caja de zinc niquelado, esfera blanca de cartón

Kalender

14 cm = 5 1/2 inches



54/11

Metallgehäuse vernickelt, Silberblatt - Metal case nickelled, silver dial
Boîte métal nickelé, cadran argenté - Caja de metal niquelado, esfera plateada

54/161

Metallgehäuse rotbraun, Weißblatt - Claret coloured metal case, white cardboard dial
Boîte métal brun-rouge, cadran carton blanc - Caja de metal rojo oscuro, esfera blanca de cartón

1 Tag Gehwerk - 1 day time - 30 heures simple - 30 horas cuerda



Azur



8 x 8 cm = 3 1/8 x 3 1/8 inches

54/121

1 Tag Wecker - 1 day alarm
30 heures réveil - 30 horas despertador

Verchromtes Metallgehäuse mit blau lackiertem Band - Chromium plated metal case with blue band - Boîte métal chromé avec ruban bleu - Caja de metal cromado y azul



7 x 13 cm = 2 7/8 x 5 1/8 inches

54/122

Verchromt poliert, Silberblatt - Chromium plated, polished, silver dial
Chromé, poli, cadran argenté - Cromado, pulido, esfera plateada



7 x 15 cm = 2 3/4 x 6 inches

54/123

Start



8 cm = 3 1/8 inches

54/101 Metallgehäuse hellrot - Metal case light red
Boîte métal rouge clair - Caja de metal rojo claro

54/102 Metallgehäuse blau - Blue metal case
Boîte métal bleu - Caja de metal azul

54/119 Metallgehäuse verchromt, Silberblatt
Chromium plated metal case, silver dial
Boîte métal chromé, cadran argenté
Caja de metal cromado, esfera plateada

Bügelabsteller - The alarm is stopped by pushing the handle down - Arrêtage du réveil par la poignée - El despertador se para doblando la manija

54/124 Metallgehäuse vernickelt mit blau lackiertem Band - Nickelled metal case with blue lacquered band - Boîte métal nickelé avec ruban bleu - Caja de metal niquelado y azul
Silberblatt - Silver dial
Cadran argenté - Esfera plateada

Gloria



8 x 6 cm = 3 x 2 1/4 inches

54/104 Metallgehäuse verchromt, Silberblatt
Chromium plated metal case, silver dial
Boîte métal chromé, cadran argenté
Caja de metal cromado, esfera plateada

54/105 Metallgehäuse rotbraun - Claret coloured metal case - Boîte métal brun-rouge - Caja de metal rojo oscuro

54/107 Metallgehäuse blau - Blue metal case
Boîte métal bleu - Caja de metal azul

Karton-Goldblatt - Gilt cardboard dial
Cadran carton doré - Esfera dorada de cartón

Bügelabsteller - The alarm is stopped by pushing the handle down - Arrêtage du réveil par la poignée - El despertador se para doblando la manija

1 Tag Wecker - 1 day alarm
30 heures réveil - Despertador, 30 horas cuerda



8,5 x 12 cm = 3 3/4 x 4 3/4 inches

54/244 Eiche - Oak - Chêne - Roble

Chromlünette, weißes Kartonblatt
Chromium plated bezel, white cardboard dial - Lunette chromée, cadran carton blanc - Bisel cromado, esfera blanca de cartón



8,5 x 12 cm = 3 3/4 x 4 3/4 inches

54/246 Nußbaum poliert - Polished walnut
Noyer poli - Nogal pulido

Goldbronzierte Lünette und Kartonblatt
Gold bronze bezel and cardboard dial
Lunette et cadran carton bronze doré
Bisel y esfera de cartón bronce dorada



8,5 x 12 cm = 3 3/4 x 4 3/4 inches

54/248 Eiche - Oak - Chêne - Roble

Chromlünette, weißes Kartonblatt - Chromium plated bezel, white cardboard dial
Lunette chromée, cadran carton blanc - Bisel cromado, esfera blanca de cartón



9,5 x 13 cm = 3 3/4 x 5 1/4 inches

54/249 Eiche - Oak - Chêne - Roble



9,5 x 13 cm = 3 3/4 x 5 1/4 inches

54/250 Nußbaum poliert - Polished walnut
Noyer poli - Nogal pulido

Chromlünette, weißes Kartonblatt - Chromium plated bezel, white cardboard dial
Lunette chromée, cadran carton blanc - Bisel cromado, esfera blanca de cartón

1 Tag Weckerwerk ohne Federhäuser - 1 day alarm movement without spring barrels
Mouvement 30 heures réveil sans barillets - Despertador 30 horas cuerda, sin barilletes

Mit oder ohne Radium-Ausstattung (RZ) - With or without luminous figures (RZ)
Avec ou sans chiffres lumineux Radium (RZ) - Con ó sin cifras luminosas Radium (RZ)



8 x 13 cm = 3 1/4 x 5 1/4 inches

54/251 Nußbaum poliert - Polished walnut
Noyer poli - Nogal pulido



9,5 x 14 cm = 3 3/4 x 5 1/2 inches

7/323 Kaukasisch Nußbaum poliert - Polished
Caucasian walnut - Noyer Caucasien poli
Nogal Caúcaso pulido

Chromlünette, Silberblatt - Chromium plated bezel, silver dial - Lunette chromée, cadran argenté
Bisel cromado, esfera plateada

1 Tag Wecker - 1 day alarm - 30 heures réveil - Despertador, 30 horas cuerda



9,5 x 17 cm = 3 3/4 x 6 3/4 inches

7/324 Kaukasisch Nußbaum poliert - Polished
Caucasian walnut - Noyer Caucasien poli
Nogal Caúcaso pulido

Neu-Triumph



7 x 6 cm = 2 3/4 x 2 1/2 inches

Messinggehäuse - Brass case - Boite laiton
Caja de latón

7/195 Vernickelt - Nickelled - Nickelé - Niquelado
Silberblatt - Silver dial - Cadran argenté
Esfera plateada

7/196 Bordorot - Claret coloured - Rouge Bordeaux
Color Burdeos
Goldblatt - Gilt dial - Cadran doré
Esfera dorado

GRUPPE 7

Miniatur-Wecker, Hohltriebwerk mit Federhaus

Miniature-Alarms, movement with lantern pinions and spring barrels - Réveils miniature,
mouvement avec pignons lanternes et barillet - Despertadores miniatura, máquina con piñones
de linterna y con barillete



Mensch und Wecker, ein besonderes Vertrauensverhältnis!

Ohne Schlaf kann der Mensch ebensowenig leben wie ohne Arbeit. Daß der eine rechtzeitig beendet, die andere aber pünktlich begonnen wird, dafür sorgt der Wecker. Je zuverlässiger er ist, um so tiefer, erfrischender ist der Schlaf und um so erfolgreicher auch die Arbeit. Voraussetzung für jenes besondere Vertrauensverhältnis ist die Qualität des Weckers. Junghans hat deswegen seit Jahrzehnten die Qualität dem „billigsten“ Preis vorangestellt. Um so verständlicher, daß es gerade der Junghans-Wecker war, der den Weltruf der Sternmarke begründete. Um so erklärlicher auch, daß er heute wieder besonders zur Förderung des Qualitätsgedankens den kräftigsten Pfeiler des deutschen Uhrenfachgeschäftes bilden sollte. Dazu berechtigen ihn auch äußerlich die bestechend schönen, knappen und praktischen Formen in den verschiedensten Preislagen.



GRUPPEN 8 und 56

Wecker in Metallgehäusen

Alarm clocks in metal cases – Réveils en boîtes métal
Despertadores en cajas de metal

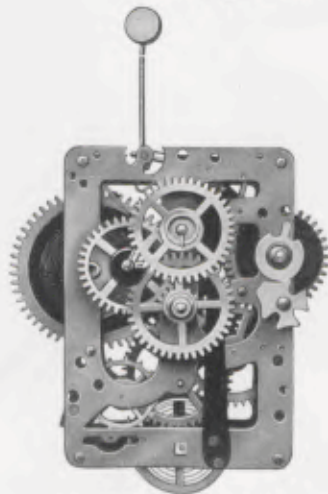

No. 10 Großes Werk
Large movement
Grand mouvement
Máquina grande

8,2 x 5,8 cm = 3 1/4 x 2 1/4 inches

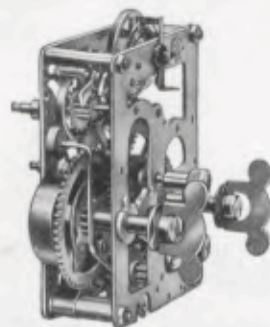

No. 10 G Großes Werk, lautlos
Large movement, silent
Grand mouvement, silencieux
Máquina grande, silenciosa

8,2 x 5,8 cm = 3 1/4 x 2 1/4 inches

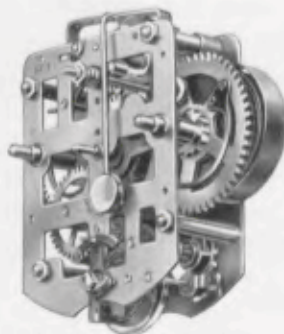

No. 231 Kleines Werk, große Balance
Small movement, large balance
Petit mouvement, grand balancier
Máquina pequeña, volante grande

No. 231 L Kleines Werk, große Balance, leise tickend
Small movement, large balance, soft ticking
Petit mouvement, grand balancier, à tic tac doux
Máquina pequeña, volante grande, á tique taque bajo

No. 231 G Kleines Werk, große Balance, lautlos
Small movement, large balance, silent
Petit mouvement, grand balancier, silencieux
Máquina pequeña, volante grande, silenciosa

7,1 x 5,6 cm = 2 7/8 x 2 1/4 inches

Die weltberühmten Weckerwerke – The world-renowned alarm movements
Les mouvements de réveils à réputation mondiale – Las máquinas de despertares de fama mundial



Globe



16 cm = 6 1/4 inches

8/246 Rotbraun – Claret coloured – Brun-rouge
Rojo oscuro

8/247 Blau – Blue – Bleu – Azul
Glocke vernickelt – Nickelated bell
Cloche nickelée – Campana niquelada

Baby



18 cm = 7 inches

8/98 Metallgehäuse vernickelt – Metal case nickelated
Boîte métal nickelé – Caja de metal niquelado

8/234 Rotbraun – Claret coloured – Brun-rouge
Rojo oscuro

8/235 Blau – Blue – Bleu – Azul

8/236 Grün – Green – Vert – Verde

Ladenpreis RM. 2.95

Stella



18 cm = 7 inches

8/100 Metallgehäuse vernickelt – Metal case nickelated
Boîte métal nickelé – Caja de metal niquelado

Ladenpreis RM. 4.—
Ladenpreis mit RZ RM. 5.—

Staubdichter Regulierschlitz – Dustproof regulating-slot – Fente de réglage hermétique – Hendrija de ajustamiento hermética

Kleines Werk – Small movement – Petit mouvement – Máquina pequeña



Baby



18 cm = 7 inches

8/242 Metallgehäuse vernickelt - Metal case nickelled
Boîte métal nickelé - Caja de metal niquelado
Ladenpreis RM. 4.50
Ladenpreis mit RZ RM. 5.50
Großes Werk, staubdichter Regulierritz
Large movement, dustproof regulating-slot
Grand mouvement, fente de réglage hermétique
Máquina grande, hendrija de ajustamiento hermética

Junghans-Baby



19 cm = 7 1/2 inches

8/2 Metallgehäuse vernickelt - Metal case nickelled
Boîte métal nickelé - Caja de metal niquelado
Ladenpreis RM. 5.50
Ladenpreis mit RZ RM. 6.50
8/2 M Messinggehäuse vernickelt - Brass case nickelled
Boîte laiton nickelé - Caja de latón niquelado
Ladenpreis RM. 6.-
Ladenpreis mit RZ RM. 7.-
Weißes Kartonblatt - White cardboard dial
Cadran carton blanc - Esfera blanca de cartón
Großes Werk, staubdichte Messing- oder Zelluloidrückwand - Large movement, dustproof brass or celluloid back - Grand mouvement, fond laiton ou fond celluloïde hermétiques - Máquina grande, respaldo hermético de latón ó celuloïde

Globe



13,5 cm = 5 1/4 inches

8/276 Rotbraun - Claret coloured - Brun-rouge
Rojo oscuro
8/277 Blau - Blue - Bleu - Azul
Ladenpreis RM. 2.95
Schlag auf Rückwand - Strike on back
Sonnerie sur fond - Tocando en el respaldo
1 Tag Wecker, kleines Werk - 1 day alarm, small movement - 30 heures réveil, petit mouvement
30 horas despertador, máquina pequeña



11 cm = 4 1/4 inches

8/333 Metallgehäuse rotbraun, Sockel verchromt
Claret coloured metal case, chromium plated base
Boîte métal brun-rouge, socle chromé
Caja de metal rojo oscuro, zócalo cromado
Ladenpreis RM. 6.-
Ladenpreis mit RZ RM. 7.-
8/334 Zahlen - Figures - Chiffres - Cifras
8/335 Striche - Strokes - Barres - Rayas
Verchromt mit blau emailliertem Band
Chromium plated with blue enamelled centre-band
Chromé avec bande émaillée bleue
Cromado con cinta esmaltada azul
Ladenpreis RM. 8.-
Ladenpreis mit RZ RM. 9.-
1 Tag Wecker, kleines Werk - 1 day alarm, small movement - 30 heures réveil, petit mouvement
30 horas despertador, máquina pequeña



Rotstern



12 cm = 4 3/4 inches

8/186 Metallgehäuse rotbraun - Claret coloured metal case - Boîte métal brun-rouge - Caja de metal, rojo oscuro
Ladenpreis RM. 5.-
Ladenpreis mit RZ RM. 6.-

Neu-Bravetto



10,5 cm = 4 1/8 inches

Metallgehäuse rotbraun
Claret coloured metal case
Boîte métal brun-rouge
Caja de metal rojo oscuro
8/266 Zahlen - Figures - Chiffres - Cifras
8/267 Striche - Strokes - Barres - Rayas
Ladenpreis RM. 4.50
Ladenpreis mit RZ RM. 5.50

1 Tag Wecker, Schlag auf Rückwand - 1 day alarm, strike on back
30 heures réveil, sonnerie sur fond - 30 horas despertador, tocando en el respaldo

Blaustern



12 cm = 4 3/4 inches

8/185 Metallgehäuse verchromt - Chromium plated metal case - Boîte métal chromé - Caja de metal cromado
Silberblatt - Silver dial - Cadran argenté
Esfera plateada
Ladenpreis RM. 7.-
Ladenpreis mit RZ RM. 8.-

Neu-Blaustern



10,5 cm = 4 1/8 inches

Metallgehäuse verchromt mit blau emailliertem Band - Chromium plated metal case with blue enamelled centre-band - Boîte métal chromé avec bande émaillée bleue - Caja de metal cromada con cinta esmaltada azul
8/268 Zahlen - Figures - Chiffres - Cifras
8/269 Striche - Strokes - Barres - Rayas
Silberblatt - Silver dial - Cadran argenté
Esfera plateada
Ladenpreis RM. 7.-
Ladenpreis mit RZ RM. 8.-

1 Tag Wecker, kleines Werk - 1 day alarm, small movement
30 heures réveil, petit mouvement - 30 horas despertador, máquina pequeña



Bravo



14,5 cm = 5 7/8 inches

- 8/198 Blau - Blue - Bleu - Azul
- 8/199 Grün - Green - Vert - Verde
- 8/200 Rotbraun - Claret coloured - Brun-rouge - Rojo oscuro
- Ladenpreis RM. 4.50
- Ladenpreis mit RZ RM. 5.50
- 1 Tag Wecker, Schlag auf Rückwand - 1 day alarm, strike on back - 30 heures réveil, sonnerie sur fond - 30 horas despertador, tocando en el respaldo
- 8/201 Mit Repetition - Repeating alarm
- Avec répétition - Con repetición
- Rotbraun - Claret coloured - Brun-rouge - Rojo oscuro
- Ladenpreis RM. 5.50
- Ladenpreis mit RZ RM. 6.50

Kleines Werk - Small movement - Petit mouvement - Máquina pequeña

Bravo J



14 cm = 5 1/2 inches

- 8/221 Metallgehäuse blau - Metal case blue
- Boîte métal bleu - Caja de metal azul
- 8/222 Metallgehäuse rotbraun - Metal case claret coloured - Boîte métal brun-rouge - Caja de metal rojo oscuro
- Ladenpreis RM. 6.-
- Ladenpreis mit RZ RM. 7.-

1 Tag Wecker, großes Werk - 1 day alarm, large movement
30 heures réveil, grand mouvement - 30 horas despertador, máquina grande

Reklame- und Sportuhr „Turner“

Advertising and sport-clock „Gymnast“ - Horloge de réclame et de Sport „Gymnaste“ - Reloj de reclamo y de deporte „Gimnasta“



14,5 cm = 5 7/8 inches

- 8/188 Rotbraun - Claret coloured - Brun-rouge
- Rojo oscuro
- Der Turner führt mit Pausen schwungvolle Übungen am Reck aus - The gymnast performs intermittently smart exercises on the horizontal bar - Le gymnaste exécute à intervalles d'exercices élastics à la barre-fixe - El gimnasta efectua á intervalos bellos ejercicios en la barra alta
- Ladenpreis RM. 11.-
- Ladenpreis mit RZ RM. 12.-



Neu-Bravo



12,5 cm = 4 7/8 inches

- Metallgehäuse rotbraun - Claret coloured metal case - Boîte métal brun-rouge - Caja de metal rojo oscuro
- 8/270 Zahlen - Figures - Chiffres - Cifras
- 8/271 Striche - Strokes - Barres - Rayas
- 1 Tag Wecker, Schlag auf Glocke - 1 day alarm, strike on bell - 30 heures réveil, sonnerie sur cloche - 30 horas despertador, campana en el fondo
- Ladenpreis RM. 5.50
- Ladenpreis mit RZ RM. 6.50

Kleines Werk - Small movement - Petit mouvement - Máquina pequeña

Halli I



14 cm = 5 1/2 inches

- 8/223 Messinggehäuse vernickelt - Brass case nickelled
- Boîte laiton nickelé - Caja de latón niquelado
- Ladenpreis RM. 9.-
- 1 Tag Wecker, großes Werk, Rückwandglocke
- 1 day alarm, large movement, back bell - 30 heures réveil, grand mouvement, timbre fond
- 30 horas despertador, máquina grande, campana en el respaldo

Neu-Bravo



12,5 cm = 4 7/8 inches

- Metallgehäuse verchromt - Chromium plated metal case - Boîte métal chromé - Caja de metal cromado
- 8/272 Zahlen - Figures - Chiffres - Cifras
- 8/273 Striche - Strokes - Barres - Rayas
- Silber- oder Kartonblatt - Silver or cardboard dial - Cadran argenté ou de carton - Esfera plateada ó de cartón
- 1 Tag Wecker, Schlag auf Glocke - 1 day alarm, strike on bell - 30 heures réveil, sonnerie sur cloche - 30 horas despertador, campana en el fondo
- Ladenpreis RM. 7.-
- Ladenpreis mit RZ RM. 8.-

Kleines Werk - Small movement - Petit mouvement - Máquina pequeña

Halli II



15 cm = 6 inches

- 8/226 Messinggehäuse bordorot - Brass case claret coloured - Boîte laiton rouge Bordeaux - Caja de latón, esmalte color Burdeos
- Ladenpreis RM. 13.-
- 1 Tag Wecker, großes Werk, Rückwandglocke, abstellbare Repetition - 1 day alarm, large movement, back bell, with both continuous and repeating alarm at option
- 30 heures réveil, grand mouvement, timbre fond, répétition à volonté - 30 horas despertador, máquina grande, campana en el respaldo, repetición á voluntad



Junghans „Leise-Tick“, der leise tickende Wecker

The alarm with soft tick - Le réveil à tic-tac doux
El despertador á tique-taque bajo



10,5 cm = 4 1/4 inches

Metallgehäuse rotbraun
Claret coloured metal case - Boîte métal brun-rouge
Caja de metal rojo oscuro

- 8/316 Zahlen - Figures - Chiffres - Cifras
- 8/317 Striche - Strokes - Barres - Rayas

Ladenpreis RM. 7.—
Ladenpreis mit RZ RM. 8.—



10,5 cm = 4 1/4 inches

Metallgehäuse verchromt mit blau emailliertem Band
Chromium plated metal case with blue enameled centre-band
Boîte métal chromé avec bande émaillée bleue
Caja de metal cromada con cinta esmaltada azul

- 8/318 Zahlen - Figures - Chiffres - Cifras
- 8/319 Striche - Strokes - Barres - Rayas

Ladenpreis RM. 9.—
Ladenpreis mit RZ RM. 10.—

- 8/324 Metallgehäuse verchromt - Chromium plated metal case - Boîte métal chromé - Caja de metal cromado
- Ladenpreis RM. 9.—
Ladenpreis mit RZ RM. 10.—



11 cm = 4 3/8 inches

Metallgehäuse verchromt mit blau emailliertem Band - Chromium plated metal case with blue enameled centre-band
Boîte métal chromé avec bande émaillée bleue - Caja de metal cromada con cinta esmaltada azul

- 8/325 Zahlen - Figures - Chiffres - Cifras
- 8/326 Striche - Strokes - Barres - Rayas

Ladenpreis RM. 10.—
Ladenpreis mit RZ RM. 11.—

Silberblatt - Silver dial - Cadran argenté - Esfera plateada

1 Tag Weckerwerk No. 231 L - 1 day alarm movement No. 231 L
30 heures réveil mouvement No. 231 L - Despertador, 30 horas cuerda, No. 231 L



Junghans „Lautlos“, der unhörbar tickende Wecker



12 cm = 4 3/4 inches

8/320 Metallgehäuse verchromt - Chromium plated metal case - Boîte métal chromé - Caja de metal cromado
Silberblatt - Silver dial - Cadran argenté
Esfera plateada

Ladenpreis RM. 11.—
Ladenpreis mit RZ RM. 12.—



10,5 cm = 4 1/4 inches

Metallgehäuse verchromt mit schwarz emailliertem Band - Chromium plated metal case with black enameled centre-band - Boîte métal chromé avec bande émaillée noire - Caja de metal cromada con cinta esmaltada negra

- 8/328 Striche - Strokes - Barres - Rayas

Silberblatt - Silver dial - Cadran argenté
Esfera plateada

Ladenpreis RM. 11.—
Ladenpreis mit RZ RM. 12.—



11 cm = 4 3/8 inches

Verchromt mit schwarz emailliertem Band
Chromium plated with black enameled centre-band - Chromé avec bande émaillée noire
Cromado con cinta esmaltada negra

- 8/329 Zahlen - Figures - Chiffres - Cifras

Ladenpreis RM. 12.—
Ladenpreis mit RZ RM. 13.—

- 8/330 Striche - Strokes - Barres - Rayas

Silberblatt - Silver dial - Cadran argenté - Esfera plateada

1 Tag Weckerwerk No. 231 G, Schlag auf Rückwand - 1 day alarm movement No. 231 G, strike on back
30 heures réveil mouvement No. 231 G, sonnerie sur fond - Despertador, 30 horas cuerda, No. 231 G, tocando en el respaldo



Junghans „Lautlos“, der unhörbar tickende Wecker

Junghans „Lautlos“



12,5 cm = 4 7/8 inches

8/299 Metallgehäuse rotbraun - Claret coloured metal case - Boîte métal brun-rouge - Caja de metal rojo oscuro
Ladenpreis RM. 10.—
Ladenpreis mit RZ RM. 11.—
Weißes Kartonblatt - White cardboard dial
Cadran carton blanc - Esfera blanca de cartón

1 Tag Weckerwerk No. 10 G, Schlag auf Glocke innen - 1 day alarm movement No. 10 G, back bell
30 heures réveil mouvement No. 10 G, timbre fond - Despertador, 30 horas cuerda No. 10 G, campana en el respaldo

Solange Wecker gebraucht werden,
solange wird auch ihr Ticken störend empfunden. Mit seinem harten Rhythmus zerreit es die Stille der Nacht und raubt vielen Menschen den heißersehten, kräftigenden Schlaf.
Schon lange wird daher an dem Problem des lautlos gehenden Weckers gearbeitet, doch ohne den rechten Erfolg, bis es endlich Junghans gelang, diese restlos befriedigende Konstruktion des lautlos tickenden Weckers zu schaffen.
Schon in einer kleinen Entfernung vom Ohr des Schlafers kann der Gang des Junghans „Lautlos“ auch in der Stille der Nacht nicht mehr gehört werden.
Junghans „Lautlos“, dieser sympathische Wecker, wird allen Menschen willkommen sein, die das Ticken bisher häufig am Einschlafen hinderte.
Wie ein stummer Diener wird er auch Ihren Schlaf bewachen und zur gewünschten Zeit, pünktlicher als der pünktlichste Diener, mit seinem hellen Weckruf beenden.

Aussi longtemps que le réveil restera un objet indispensable,
aussi longtemps son tic-tac nous dérangera. Il déchire par son dur rythme le silence de la nuit et ôte à beaucoup de personnes le sommeil reconfortant et attendu avec tant d'ardeur.
C'est donc depuis bien longtemps que l'on cherche à solutionner le problème d'un réveil à marche silencieuse, mais sans vrai succès, jusqu'à ce que Junghans a réussi à créer cette construction satisfaisante sous tous les rapports.
A une distance de 15 cm seulement de l'oreille du dormeur, la marche de Junghans „Silent“ (sans tic-tac) n'est déjà plus perceptible, même au milieu du silence de la nuit.
Junghans „Silent“, ce réveil sympathique, sera le bienvenu de toutes les personnes empêchées parfois de s'endormir à cause du tic-tac.
Aussi veillera-t-il, tel un serviteur muet, sur votre sommeil pour lui dicter, avec plus de ponctualité que le serviteur le plus ponctuel, la fin à l'heure fixée d'avance, par sa sonnerie claire.

Junghans „Lautlos“



12,5 cm = 4 7/8 inches

8/300 Metallgehäuse verchromt mit blau emailliertem Band - Chromium plated metal case with blue enamelled centre-band - Boîte métal chromé avec bande émaillée bleue - Caja de metal cromada con cinta esmaltada azul
Ladenpreis RM. 12.—
Ladenpreis mit RZ RM. 13.—
Silberblatt - Silver dial - Cadran argenté
Esfera plateada

Ever since Alarms have been in use,
their ticking has had an annoying effect. Their harsh rhythm severs the quietness of the night and deprives many people of their coveted, refreshing sleep.
The many efforts made in the past to create a noiseless alarm were only partially successful until Junghans, at last, succeeded in solving this problem entirely.
Placed only four inches from the ear of the sleeper, the action of Junghans „Silent“ is imperceptible, even in the quietness of night.
Junghans „Silent“ this appealing alarm, will be welcomed by all those whom the ticking of the alarm hitherto frequently prevented from dropping off to sleep. It will also guard your sleep like a silent servant and will call you by its clear ringing at the desired time, more punctually than the most punctual servant.

En tanto que el despertador esté en uso,
en tanto su tique-taque quedará perturbativo. Con su duro ritmo rompe el silencio de la noche, robando a muchísimas personas el sueño reconfortativo y esperado ansiosamente.
Desde hace mucho tiempo se está buscando pues la solución del problema de un despertador a marcha silenciosa, sin lograrlo, sin embargo, hasta que Junghans recientemente ha tenido la suerte de resolverlo por la actual construcción, satisfactoria bajo todos los conceptos.
A una distancia de no más de 15 cm de la oreja del durmiente, la marcha del Junghans „Silent“ (sin tique-taque) ya no se percibe en medio de la noche silenciosa. Junghans „Silent“ será el bienvenido de cuantas personas que frecuentemente hayan sido impedidas de dormirse por motivo del tique-taque.
Tal un servidor mudo velará el Junghans „Silent“ sobre su sueño, para terminarlo, con mayor puntualidad que el más puntual servidor, en la hora precisa fijada, por su sonería clara.



GRUPPE 9

Wecker in Holzgehäusen

Alarm clocks in wooden cases - Réveils en boîtes bois
Despertadores en cajas de madera



12 x 22 cm = 4 7/8 x 8 3/4 inches

9/133

Eiche - Oak - Chêne - Roble

Kartonblatt - Cardboard dial - Cadran carton - Esfera de cartón



12 x 22 cm = 4 7/8 x 8 3/4 inches

9/134

Kaukasisch Nußbaum poliert - Polished Caucasian walnut
Noyer Caucasiens poli - Nogal Caúcaso pulido

Chromlunette, Silberblatt - Chromium plated bezel, silver dial
Lunette chromée, cadran argenté - Bisel cromado, esfera plateada

Ladenpreis ohne RZ RM. 17.—
Ladenpreis mit RZ RM. 18.—

1 Tag Wecker mit oder ohne RZ - 1 day alarm - 30 heures réveil - 30 horas cuerda, despertador

9/133: In allen Eichenfarben lieferbar - Can be had in all oak colours
Livrables en toutes teintes de chêne - Se hacen en todos los colores de roble



GRUPPE 10

Schreibtischuhren

Writing table clocks - Pendulettes de bureau - Relojes para escritorio



13,5 x 10,5 cm = 5 1/4 x 7 1/4 inches

10/62 Kaukasisch Nußbaum poliert - Polished Caucasian walnut - Noyer Caucasiens poli - Nogal Caúcaso pulido

Ladenpreis RM. 27.—

10/66 Kaukasisch Nußbaum matt - Mat Caucasian walnut - Noyer Caucasiens mat - Nogal Caúcaso mate

Silberblatt - Silver dial - Cadran argenté - Esfera plateada

Ladenpreis RM. 22.—



12 x 30 cm = 4 3/4 x 11 3/4 inches

10/67 Eiche mit Nußbaum poliert - Oak with polished walnut

Chêne avec noyer poli - Roble con nogal pulido

Silberzahlenreif - Silvered figure-circle - Cercle à chiffres argenté

Cerco de cifras plateado

Ladenpreis RM. 27.—



12 x 30 cm = 4 3/4 x 11 3/4 inches

10/68 Kaukasisch Nußbaum poliert - Polished Caucasian walnut

Noyer Caucasiens poli - Nogal Caúcaso pulido

Silberzahlenreif - Silvered figure-circle - Cercle à chiffres argenté

Cerco de cifras plateado

Ladenpreis RM. 33.—

Chromlunette - Chromium plated bezel - Lunette chromée - Bisel cromado

8 Tag Ankergehwerk - 8 day lever time movement

8 jours simple, échappement à ancre - Máquina, 8 días cuerda, escape á áncora



12 x 23 cm = 4 3/4 x 9 1/4 inches

10/69 Eiche mit Nußbaum poliert - Oak with polished walnut
Chêne avec noyer poli - Roble con nogal pulido

Silberzahlenreif - Silvered figure-circle

Cercle à chiffres argenté - Cerco de cifras plateado



12 x 25 cm = 4 3/4 x 9 3/4 inches

10/70 Kaukasisch Nußbaum poliert - Polished Caucasian walnut
Noyer Caucasiens poli - Nogal Caúcaso pulido

Silberzahlenreif - Silvered figure-circle

Cercle à chiffres argenté - Cerco de cifras plateado

Ladenpreis RM. 28.—



12 x 22 cm = 4 3/4 x 8 3/4 inches

10/71 Kaukasisch Nußbaum poliert - Polished Caucasian walnut
Noyer Caucasiens poli - Nogal Caúcaso pulido

Silberblatt - Silver dial - Cadran argenté - Esfera plateada

Ladenpreis RM. 22.—

Chromlunette - Chromium plated bezel - Lunette chromée - Bisel cromado

8 Tag Ankergehwerk - 8 day lever time movement

8 jours simple, échappement à ancre - Máquina, 8 días cuerda, escape á áncora



GRUPPE 12

Schiffsuhren

Ship Clocks - Horloges marine - Relojes Marina

Marine



Gehäuse-Durchmesser - Diameter of case
Diamètre de la cage - Diámetro de la caja
12/1: 16,5 cm = 6 1/2 inches
12/4, 12/39: 25 cm = 10 inches
12/41: 29 cm = 11 1/2 inches

Zifferblatt-Durchmesser - Diameter of dial
Diamètre du cadran - Diámetro de la esfera
12/1: 10,5 cm = 4 inches
12/4, 12/39: 16,5 cm = 6 inches
12/41: 20,5 cm = 8 inches

12/1, 12/4 1 Tag Gehwerk - 1 day time
30 heures simple - 30 horas movimiento solo

12/39, 12/41 8 Tag Gehwerk - 8 day time
8 jours simple - 8 días movimiento solo

Nußbaum - Walnut - Noyer - Nogal
Lackblatt - Lacquered dial - Cadran verni - Esfera esmaltada

Flotte



Gehäuse-Durchmesser - Diameter of case - Diamètre de la cage - Diámetro de la caja 19,5 cm = 7 1/2 inches
Zifferblatt-Durchmesser - Diameter of dial - Diamètre du cadran - Diámetro de la esfera 13 cm = 5 inches

Messinggehäuse - Brass case - Boîte laiton - Caja de latón
12/10 Vernickelt - Nickelled - Nickelé - Niquelado
Silberblatt - Silver dial - Cadran argenté - Esfera plateada

8 Tag Präzisions-Gehwerk, Echappement mit 4 Steinen - 8 day precision time movement, escapement with 4 jewels
Mouvement de précision, 8 jours simple, échappement avec 4 rubis - Máquina de precisión, 8 días cuerda, escape à ancóra con 4 rubis



GRUPPE 14

Autouhren

Motor car clocks - Montres pour auto - Relojes para automovil

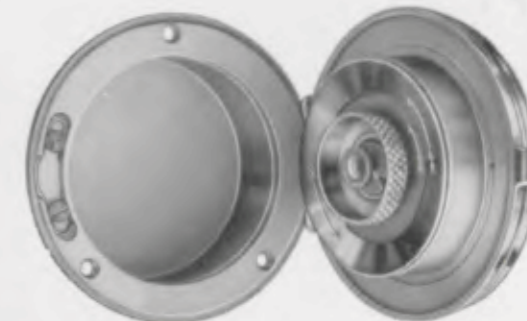
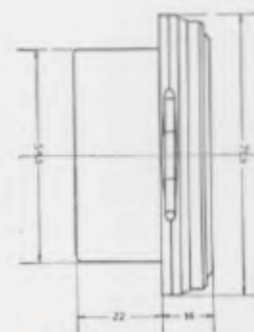

7 cm = 2 3/4 inches

14/23 8 Tag Taschenuhr-Präzisionswerk No. J 30, 7steinig, Metallblatt weiß oder schwarz
8 day precision watch movement No. J 30, 7 jewels, white or black metal dial
Mouvement de montre de précision No. J 30, 7 rubis, cadran métal blanc ou noir
Máquina de reloj de bolsillo de precisión No. J 30, 8 días cuerda, 7 rubis, esfera de metal blanca ó negra
Messinggehäuse vernickelt - Brass case nickelled - Boîte laiton nickelé - Caja de latón niquelado

Ladenpreis RM. 36.—

Autouhr mit Scharnier

Motor car clock with hinge - Montre pour auto avec charnière - Reloj para automovil con charnela



Durchmesser 65 mm
Diameter 65 mm - Diamètre 65 mm - Diámetro 65 mm

Durchmesser 80 mm
Diameter 80 mm - Diamètre 80 mm - Diámetro 80 mm

14/121

14/122

8 Tag Ankergehwerk No. J 44 ohne Steine - 8 day lever time movement No. J 44 without jewels
Mouvement No. J 44, 8 jours simple, échappement à ancóra, sans rubis
Máquina No. J. 44, 8 días cuerda, escape à ancóra, sin rubis

Ladenpreis RM. 21.50

Ladenpreis RM. 21.50

Messinggehäuse vernickelt - Brass case nickelled - Boîte laiton nickelé - Caja de latón niquelado

Metallblatt weiß oder schwarz - White or black metal dial
Cadran métal blanc ou noir - Esfera de metal blanca ó negra

Mit oder ohne leuchtende Radiumziffern (RZ) - With or without luminous figures (RZ)
Avec ou sans chiffres lumineux au Radium (RZ) - Con ó sin cifras luminosas Radium (RZ)



Die „heutige“ Möbelform ist nicht heutig!

Sie ist vielmehr nur ein Verlegenheitsgriff in vergangene Stil-Epochen, ein Geschäftstrick sozusagen, der Geliebtenes an die Stelle von organisch Gewachsenem setzen möchte. So etwas kann nur vorübergehend sein. Wir haben deshalb in den Junghans-Tischuhren-Neuheiten eine Anlehnung angestrebt, die sowohl zu den sogenannten Stilmöbeln paßt als auch zu der immer noch stark vertretenen gemilderten Sachlichkeit, die zuletzt in Rundungen, Schweifungen und barocken Anklängen ausschwang. Damit haben wir einen für den Uhrmacher sehr vorteilhaften Weg beschritten, der sehr leichte Verkäuflichkeit dieser Tischuhren infolge beinahe universeller Paßform verspricht und die Gefahr von Ladenhütern beseitigt. In allen Preislagen, ganz besonders in den billigen, sind die Preise derartig niedrig, daß sie die unterste Grenze des Möglichen erreicht haben.



GRUPPE 17

Kaminuhren

Mantle Clocks — Pendules de cheminée — Relojes de sobremesa

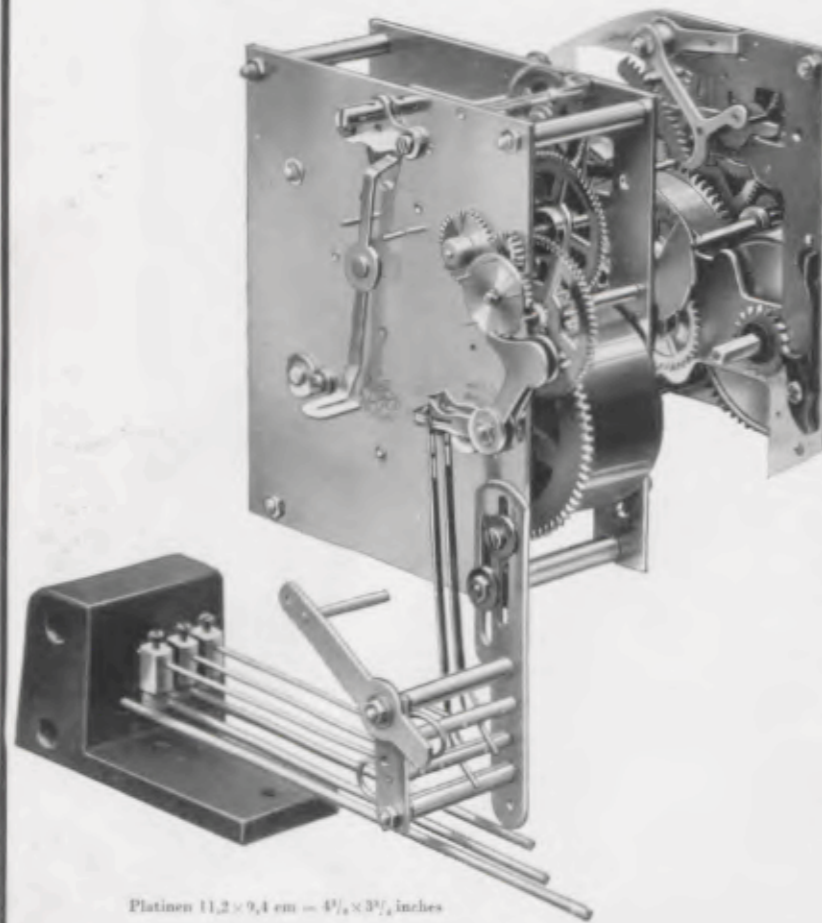

Platinen 11,2 x 9,4 cm = 4 1/4 x 3 3/4 inches

No. 203 A

14 Tag Halbstund-Rechenschlagwerk Bim Bam

Neue zweckmäßige Hammerhebung
Voller, schöner Schlag durch neue
Hammeranordnung
Herausnehmbare Federhäuser

Die zweckmäßige Konstruktion erlaubt
leichtes Reparieren

14 day half-hour rack-strike movement
Bim Bam

New efficacious hammer-lifting
Full, nice strike by new arrangement of
hammers

Interchangeable spring barrels
Easy to repair

Mouvement à râteau 15 jours sonnerie
heures et demies Bim Bam

Elévation nouvelle et pratique des mar-
teaux

Sonnerie pleine et belle grâce à une
nouvelle disposition des marteaux
Barillets interchangeables

Facile à réparer

Máquina á sierra 15 días sonería horas
y medias Bim Bam

Elevación nueva y práctica de los martillos
Sonería plena y bonita que se ha ob-
tenido por medio de una nueva dis-
posición de los martillos
Barilletes intercambiables

Se deja reparar facilmente

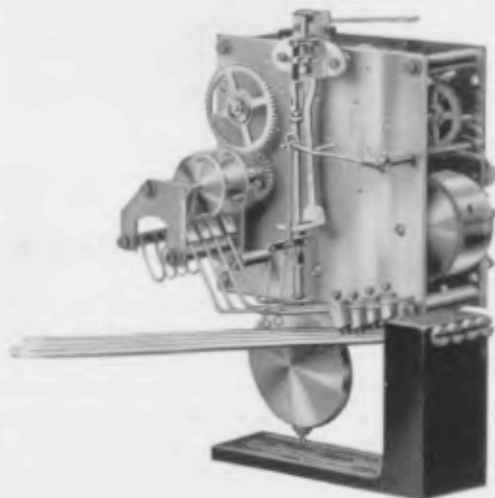

Platinen 10,5 x 10,5 cm = 4 1/8 x 4 1/8 inches

Werk No. 200

8 Tag 3/4 Westminsterschlag, massive Triebe

8 day 3/4 Westminster chime, solid pinions

8 jours 3/4 Carillon Westminster, pignons massifs

8 días 3/4 Carillon Westminster, piñones macizos



21 x 41 cm = 8 1/4 x 16 1/4 inches

Eiche - Oak - Chêne - Roble

17/647 B Bachgong - Gong „Bim Bam“

Chromlunette, Silberzahlenreif - Chromium plated bezel, silvered figure
Lunette chromée, cercle à chiffres argenté - Bisel cromado, cerco de cifras



23,5 x 52 cm = 10 x 20 1/2 inches

Eiche - Oak - Chêne - Roble

17/542 B Bachgong - Gong „Bim Bam“

Dial - Cadran - Esfera 18 cm = 7 inches

...RM. 45.—



27 x 59 cm = 10 3/4 x 23 1/4 inches

Eiche - Oak - Chêne - Roble

17/544 B Bachgong - Gong „Bim Bam“

17/544 W 1/4 Westminsterschlag - 1/4 Westminster chime - 1/4 Carillon Westminster

Ladenpreis für „Bim Bam“ RM. 50.—



27 x 56 cm = 10 3/4 x 22 inches

Eiche - Oak - Chêne - Roble

17/545 B Bachgong - Gong „Bim Bam“

Zifferblatt - Dial - Cadran - Esfera 18 cm = 7 inches

In Eiche roh, 40 und 45 lieferbar



27 x 54 cm = 10 1/2 x 21 1/4 inches

Eiche - Oak - Chêne - Roble

17/569 B Bachgong - Gong „Bim Bam“

Zifferblatt - Dial - Cadran - Esfera 15 x 18,5 cm = 6 x 7 1/4 inches



31 x 68 cm = 12 1/4 x 26 3/4 inches

Eiche - Oak - Chêne - Roble

17/547 B Bachgong - Gong „Bim Bam“

17/547 W 1/4 Westminsterschlag - 1/4 Westminster chime - 1/4 Carillon Westminster

Zifferblatt - Dial - Cadran - Esfera 20 cm = 8 inches

In Eiche roh, 40 und 45 lieferbar



21 x 41 cm = 8 1/4 x 16 1/4 inches

Nußbaum poliert - Polished walnut - Noyer poli - Nogal pulido

17/528 B Bachgong - Gong „Bim Bam“

Zifferblatt - Dial - Cadran - Esfera 15 cm = 6 inches



25 x 52,5 cm = 9 7/8 x 20 3/4 inches

Nußbaum poliert - Polished walnut - Noyer poli - Nogal pulido

17/548 B Bachgong - Gong „Bim Bam“

Chromlünette, Silberzahlenreif - Chromium plated bezel, silvered figure-circle
Lunette chromée, cercle à chiffres argenté - Bisel cromado, cerco de cifras plateado 18 cm = 7 inches

Ladenpreis RM. 65.—

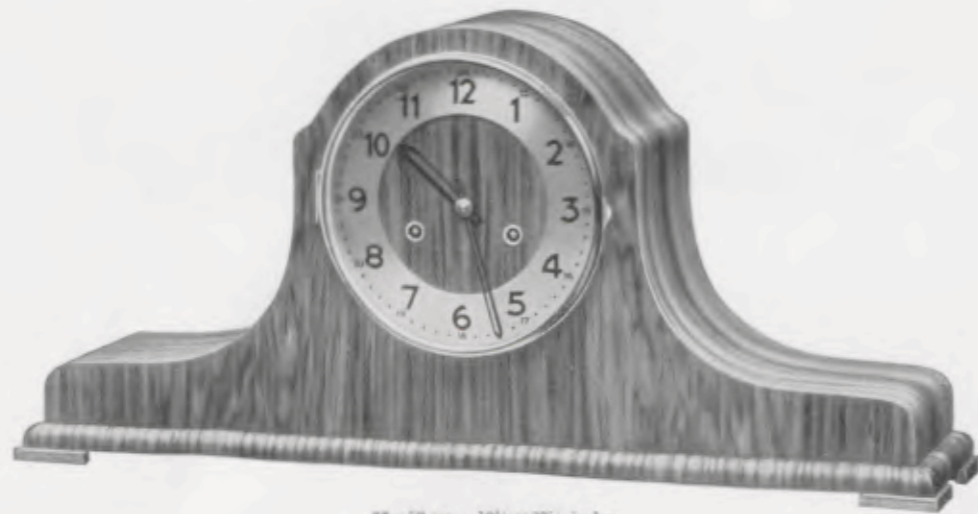

27 x 59 cm = 10 5/8 x 23 1/4 inches

Nußbaum poliert - Polished walnut - Noyer poli - Nogal pulido

17/549 B

Bachgong - Gong „Bim Bam“

Chromlünette, Silberzahlenreif - Chromium plated bezel, silvered figure-circle
Lunette chromée, cercle à chiffres argenté - Bisel cromado, cerco de cifras plateado

18 cm = 7 inches



21 x 33 cm = 8 1/4 x 13 inches

Eiche - Oak - Chêne - Roble

17/611 B Matt vergoldete Zahlen und Zeiger
Mat gilt figures and hands
Chiffres et aiguilles dorés mat
Cifras y agujas doradas mate

17/612 B Verchromte Zahlen und Zeiger
Chromium plated figures and hands
Chiffres et aiguilles chromés
Cifras y agujas cromadas

Bachgong - Gong „Bim Bam“



21 x 33 cm = 8 1/4 x 13 inches

17/613 B Eiche - Oak - Chêne - Roble

Chromlünette, Zahlenreif versilbert
Chromium plated bezel, silvered figure-circle
Lunette chromée, cercle à chiffres argenté
Bisel cromado, cerco de cifras plateado

16 cm = 6 1/4 inches

Bachgong - Gong „Bim Bam“



21 x 33 cm = 8 1/4 x 13 inches

17/614 B Eiche mit polierter Nußbaumfront
Oak with polished walnut front
Chêne avec front noyer poli
Roble con frente nogal pulido

Matt versilberte Zahlen und Zeiger
Mat-silvered figures and hands
Chiffres et aiguilles argentés, mat
Cifras y agujas plateadas, mate

Bachgong - Gong „Bim Bam“

Ladenpreis RM. 35.—

Eichengehäuse in roh, Farben 40 und 45 lieferbar



21 x 33 cm = 8 1/4 x 13 inches

17/615 B Eiche mit polierter Nußbaumfront
Oak with polished walnut front
Chêne avec front noyer poli
Roble con frente nogal pulido

Chromlunette, Zahlenreif versilbert
Chromium plated bezel, silvered figure-circle
Lunette chromée, cercle à chiffres argenté
Bisel cromado, cerco de cifras plateado
16 cm = 6 1/4 inches

Bachgong - Gong „Bim Bam“

LadenpreisRM. 38.—

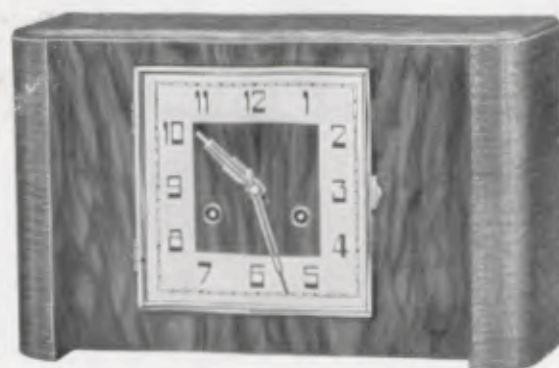

21 x 33 cm = 8 1/4 x 13 inches

17/644 B Eiche mit polierter Nußbaumfront
Oak with polished walnut front
Chêne avec front noyer poli
Roble con frente nogal pulido

Chromlunette, Zahlenreif versilbert
Chromium plated bezel, silvered figure-circle
Lunette chromée, cercle à chiffres argenté
Bisel cromado, cerco de cifras plateado
15 x 15 cm = 6 x 6 inches

Bachgong - Gong „Bim Bam“



20 x 33 cm = 8 x 13 inches

17/635 B Kaukasisch Nußbaum poliert
Polished Caucasian walnut
Noyer Caucasiens poli
Nogal Caúcaso pulido

Matt versilberte Zahlen und Zeiger
Mat-silvered figures and hands
Chiffres et aiguilles argentés, mat
Cifras y agujas plateadas, mate

Bachgong - Gong „Bim Bam“



20 x 33 cm = 8 x 13 inches

17/636 Kaukasisch Nußbaum poliert
Polished Caucasian walnut
Noyer Caucasiens poli
Nogal Caúcaso pulido

Chromlunette, Zahlenreif versilbert
Chromium plated bezel, silvered figure-circle
Lunette chromée, cercle à chiffres argenté
Bisel cromado, cerco de cifras plateado
17 cm = 6 3/4 inches

Bachgong - Gong „Bim Bam“

3/4 Westminsterschlag - 1/4 Westminster
chime - 1/4 Carillon Westminster

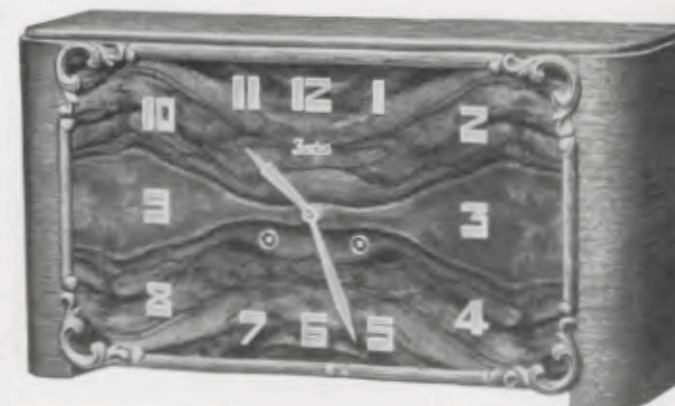

21 x 39 cm = 8 1/4 x 15 1/2 inches

17/643 B Eiche mit kaukasisch Nußbaumfront, poliert
Oak with polished Caucasian walnut front
Chêne avec front noyer Caucasiens poli
Roble con frente nogal Caúcaso pulido

Matt versilberte Zahlen und Zeiger
Mat-silvered figures and hands
Chiffres et aiguilles argentés, mat
Cifras y agujas plateadas, mate

Bachgong - Gong „Bim Bam“



21 x 40 cm = 8 1/4 x 15 3/4 inches

17/632 B Kaukasisch Nußbaum poliert
Polished Caucasian walnut
Noyer Caucasiens poli
Nogal Caúcaso pulido

Matt versilberte Zahlen und Zeiger
Mat-silvered figures and hands
Chiffres et aiguilles argentés, mat
Cifras y agujas plateadas, mate

Bachgong - Gong „Bim Bam“

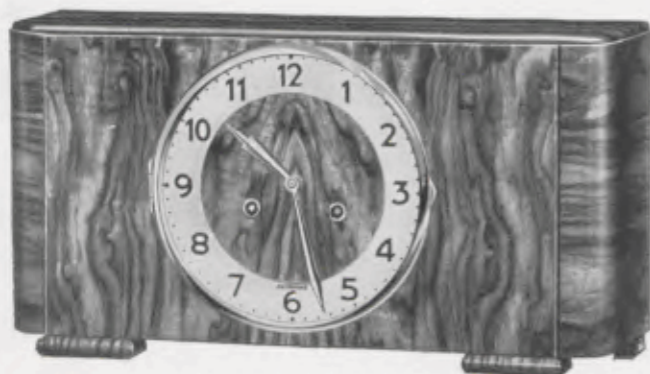

21 x 40 cm = 8 1/4 x 15 3/4 inches

17/633 B Kaukasisch Nußbaum poliert
Polished Caucasian walnut
Noyer Caucasiens poli
Nogal Caúcaso pulido

Chromlünette, Zahlenreif versilbert
Chromium plated bezel, silvered figure-circle
Lunette chromée, cercle à chiffres argenté
Bisel cromado, cerco de cifras plateado
17 cm = 6 3/4 inches

Bachgong - Gong „Bim Bam“
Ladenpreis RM. 50.—



21,5 x 30 cm = 8 1/2 x 11 1/4 inches

17/554 B Kaukasisch Nußbaum matt
Mat Caucasian walnut
Noyer Caucasiens mat
Nogal Caúcaso mate

Chromlünette, Zahlenreif versilbert
Chromium plated bezel, silvered figure-circle
Lunette chromée, cercle à chiffres argenté
Bisel cromado, cerco de cifras plateado
17 cm = 6 3/4 inches

Bachgong - Gong „Bim Bam“

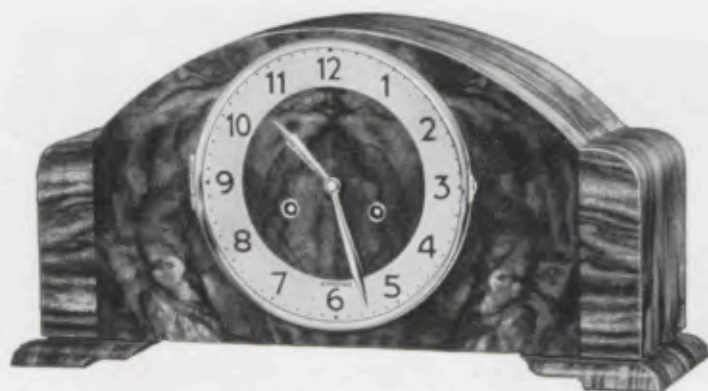

21 x 42 cm = 8 1/4 x 16 1/2 inches

17/631 Kaukasisch Nußbaum poliert
Polished Caucasian walnut
Noyer Caucasiens poli
Nogal Caúcaso pulido

Chromlünette, Zahlenreif versilbert
Chromium plated bezel, silvered figure-circle
Lunette chromée, cercle à chiffres argenté
Bisel cromado, cerco de cifras plateado
18 cm = 7 inches

Bachgong - Gong „Bim Bam“
3/4 Westminsterschlag - 3/4 Westminster
chime - 3/4 Carillon Westminster



21 x 40 cm = 8 1/4 x 15 3/4 inches

17/656 B Kaukasisch Nußbaum poliert
Polished Caucasian walnut
Noyer Caucasiens poli
Nogal Caúcaso pulido

Chromlünette, Zahlenreif und Zeiger versilbert
Chromium plated bezel, silvered figure-circle and hands
Lunette chromée, aiguilles et cercle à chiffres argentés
Bisel cromado, cerco de cifras y agujas plateados
17 cm = 6 3/4 inches

Ladenpreis für „Bim Bam“ ... RM. 55.—



21 x 40 cm = 8 1/4 x 15 3/4 inches

17/652 B Matt versilberte Zahlen und Zeiger
Mat-silvered figures and hands
Chiffres et aiguilles argentés, mat
Cifras y agujas plateadas, mate

17/653 B Matt versilberte Striche und Zeiger
Mat-silvered strokes and hands
Barres et aiguilles argentées, mat
Rayas y agujas plateadas, mate

Kaukasisch Nußbaum poliert
Polished Caucasian walnut
Noyer Caucasiens poli
Nogal Caúcaso pulido

Ladenpreis für „Bim Bam“ ... RM. 55.—



21 x 40 cm = 8 1/4 x 15 3/4 inches

17/654 Kaukasisch Nußbaum poliert
Polished Caucasian walnut
Noyer Caucasiens poli
Nogal Caúcaso pulido

Chromlünette, Zahlenreif versilbert
Chromium plated bezel, silvered figure-circle
Lunette chromée, cercle à chiffres argenté
Bisel cromado, cerco de cifras plateado
18 cm = 7 inches

Bachgong - 3/4 Westminsterschlag

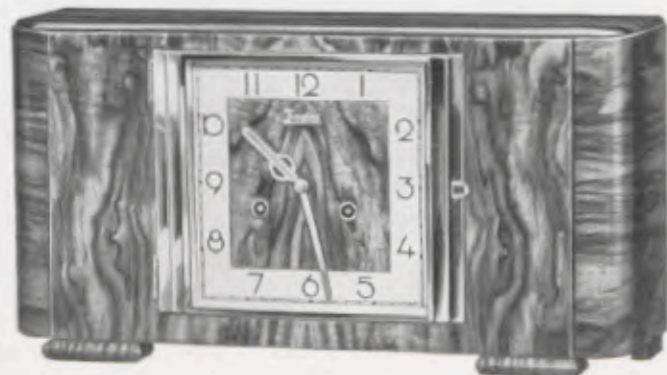

21 x 40 cm = 8 1/4 x 15 7/8 inches

17/634 B Kaukasisch Nußbaum poliert
Polished Caucasian walnut
Noyer Caucasiens poli
Nogal Caúcaso pulido

Chromlünette, Zahlenreif versilbert
Chromium plated bezel, silvered figure-circle

Lunette chromée, cercle à chiffres argenté
Bisel cromado, cerco de cifras plateado

16 x 19,5 cm = 6 1/4 x 7 3/4 inches

Ladenpreis für „Bim Bam“ ... RM. 60.—



21,5 x 44 cm = 8 1/2 x 17 1/4 inches

17/577 B Kaukasisch Nußbaum poliert
Polished Caucasian walnut
Noyer Caucasiens poli
Nogal Caúcaso pulido

Chromlünette, Zahlenreif versilbert
Chromium plated bezel, silvered figure-circle

Lunette chromée, cercle à chiffres argenté
Bisel cromado, cerco de cifras plateado

18 cm = 7 inches

Ladenpreis für „Bim Bam“ ... RM. 65.—



23 x 40 cm = 9 x 15 1/4 inches

17/650 Matt versilberte Zahlen und Zeiger
Mat-silvered figures and hands
Chiffres et aiguilles argentés, mat
Cifras y agujas plateadas, mate

Ladenpreis für „Bim Bam“ ... RM. 65.—

17/651 Matt versilberte Striche und Zeiger
Mat-silvered strokes and hands
Barres et aiguilles argentées, mat
Rayas y agujas plateadas, mate

Ladenpreis für „Bim Bam“ ... RM. 65.—

Kaukasisch Nußbaum poliert
Polished Caucasian walnut
Noyer Caucasiens poli
Nogal Caúcaso pulido
Bachgong - 1/4 Westminsterschlag



21 x 42 cm = 8 1/4 x 16 1/2 inches

17/638 B Kaukasisch Nußbaum poliert
Polished Caucasian walnut
Noyer Caucasiens poli
Nogal Caúcaso pulido

Chromlünette, Zahlenreif versilbert
Chromium plated bezel, silvered figure-circle

Lunette chromée, cercle à chiffres argenté
Bisel cromado, cerco de cifras plateado

18 cm = 7 inches

Bachgong - Gong „Bim Bam“



17/639 B Kaukasisch Nußbaum poliert
Polished Caucasian walnut
Noyer Caucasiens poli
Nogal Caúcaso pulido

Chromlünette, Zahlenreif und Zeiger versilbert

Chromium plated bezel, silvered figure-circle and hands

Lunette chromée, aiguilles et cercle à chiffres argentés

Bisel cromado, cerco de cifras y agujas plateados

18 cm = 7 inches

Bachgong - Gong „Bim Bam“

Ladenpreis ... RM. 75.—

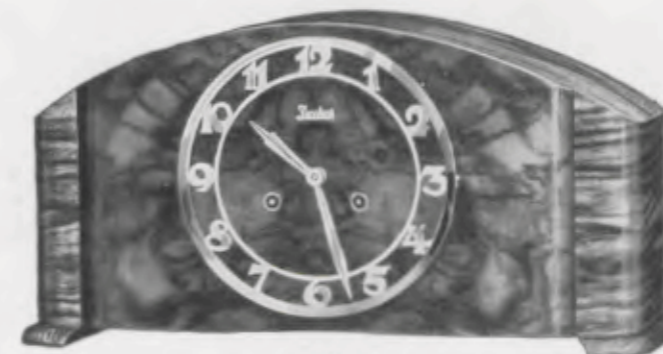

21 x 42 cm = 8 1/4 x 16 1/2 inches



21 x 42 cm = 8 1/4 x 16 1/2 inches

17/641 B Kaukasisch Nußbaum poliert
Polished Caucasian walnut
Noyer Caucasiens poli
Nogal Caúcaso pulido

Chromlünette, Zahlenreif versilbert
Chromium plated bezel, silvered figure-circle

Lunette chromée, cercle à chiffres argenté
Bisel cromado, cerco de cifras plateado

18 cm = 7 inches

Bachgong - Gong „Bim Bam“

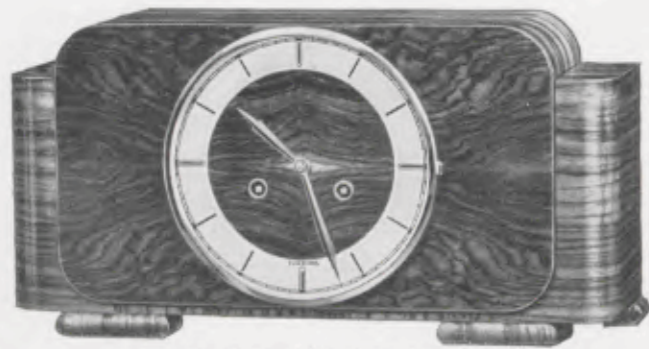

21 x 42 cm = 8 1/4 x 16 1/2 inches

17/658 B Kaukasisch Nußbaum poliert
Polished Caucasian walnut
Noyer Caucasiens poli
Nogal Caúcaso pulido

Chromlünette, Silberreif mit schwarzen Strichen

Chromium plated bezel, silvered circle with black strokes

Lunette chromée, cercle argenté avec barres noires

Bisel cromado, cerco plateado con rayas negras

18 cm = 7 inches

Ladenpreis für „Bim Eam“ ...RM. 75.—



22 x 43 cm = 8 1/2 x 17 inches

17/642 B Kaukasisch Nußbaum poliert
Polished Caucasian walnut
Noyer Caucasiens poli
Nogal Caúcaso pulido

Chromlünette, Zahlenreif und Zeiger versilbert

Chromium plated bezel, silvered figure-circle and hands

Lunette chromée, aiguilles et cercle à chiffres argentés

Bisel cromado, cerco con cifras y agujas plateados

18 cm = 7 inches

Ladenpreis für „Bim Bam“ ...RM. 75.—

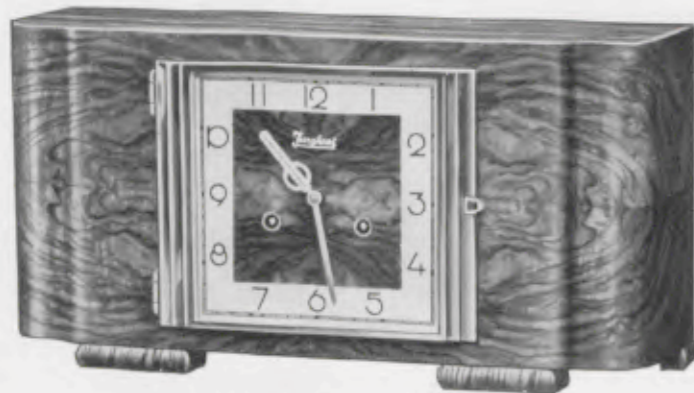

20 x 40 cm = 8 x 15 3/4 inches

17/655 B Kaukasisch Nußbaum poliert
Polished Caucasian walnut
Noyer Caucasiens poli
Nogal Caúcaso pulido

Chromlünette, Zahlenreif versilbert

Chromium plated bezel, silvered figure-circle

Lunette chromée, cercle à chiffres argenté

Bisel cromado, cerco con cifras plateado
16 x 19,5 cm = 6 1/4 x 7 3/4 inches

Bachgong - Gong „Bim Bam“



Konsole No. 1 — Bracket No. 1

Console No. 1 — Consola No. 1

58 x 6 x 16,5 cm = 22 3/4 x 2 1/4 x 6 1/2 inches

Kaukasisch Nußbaum poliert — Polished Caucasian walnut
Noyer Caucasiens poli — Nogal Caúcaso pulido

Für alle Junghans-Tischuhren in kaukasisch Nußbaum poliert lieferbar

Can be used for all clocks with polished Caucasian walnut

Avec console sont livrables tous les modèles en noyer Caucasiens poli

Con consola se suministran todos los modelos en nogal Caúcaso pulido

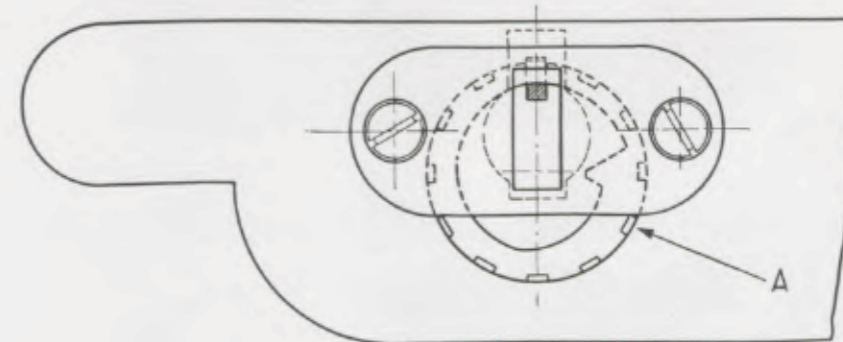

Aufhängevorrichtung der Konsole. D. R. P. A.

Durch Drehen der Scheibe A kann die Konsole jederzeit leicht in eine absolut wagrechte Lage gebracht werden.

Suspension device of bracket. Patented.

The bracket can easily be brought into an absolutely horizontal position by turning disc A.

Appareil de suspension de la console D. R. P. A.

En tournant le disque A, on peut en tout temps mettre la console en position absolument horizontale.

Aparato para suspender la consola D. R. P. A.

Dando vueltas al disco A, la consola siempre se puede poner facilmente en una posición absolutamente horizontal.



**Nach anfänglicher Verkennung
Schleiflack „heute“
stark gefragt!**

Warum, das ist belanglos. Wichtig ist nur, man hat, sowohl Publikum wie Uhrmacher, eine heiße Liebe zu diesen neuen Uhren in Schleiflack entdeckt. Kein Wunder, daß sie auch sehr zahlreich unter den jetzigen Junghans-Neuheiten vertreten sind. — Wo sie überall hinpassen? Farbe, Form, Gesicht und ein sicherer Geschmack bestimmen das. Küche, Wohndiele, Diele, Frühstückszimmer, Schlafzimmer, auch Konditoreien usw. sind Räume, in die sie überall ausgezeichnet passen, wenn sie mit sicherem Gefühl ausgewählt werden. Mit ihren Preisen und mit ihrer reichhaltigen Auswahl werden sie beinahe an jede Käuferschicht Anschluß finden.



GRUPPE 18

Einsatzuhren

Rundrahmenuhren * Bürouhren * Dropuhren

Clocks for fitting into furniture
Dial Clocks * Office Clocks * Drop Dial Clocks

Pendules à encastrer
Ceils de Bœuf * Pendules pour Bureaux * Pendules octogones

Relojes para colocar en estantes, muebles etc.
Relojes de pared, forma ojo de buey * Relojes para despachos

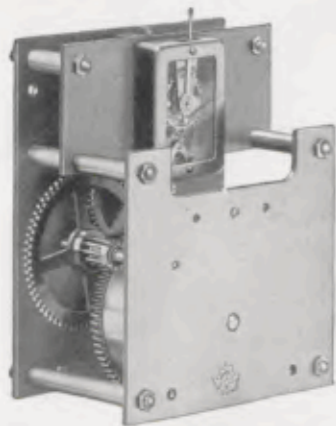

No. 146 8 Tag Marine-Präzisionswerk mit 7 Steinen, staubdicht abgedeckte Taschenuhrhemmung
Precision lever movement, 8 day time, escapement with 7 jewels under dustproof protector
Mouvement de précision, 8 jours simple, échappement hermétiquement fermé avec 7 rubis
Máquina de precisión, 8 días cuerda, escape hermético á áncora con 7 rubis

Platinen — Plates — Platines — Platinas
9,5 x 7,5 cm = 3 7/8 x 3 inches



Platinen — Plates — Platines — Platinas
9 x 6 cm = 3 1/2 x 2 1/4 inches

No. 184 8 Tag Anker-Gehwerk mit Echappement
8 day lever time movement with escapement
8 jours simple, échappement à ancre
Máquina 8 días cuerda, escape á áncora



9,5 x 7 cm = 3 7/8 x 2 7/8 inches

No. 25 14 Tag Pendelgehwerk
14 day pendulum time movement
Mouvement à balancier, 15 jours simple
Máquina á péndola, 15 días cuerda

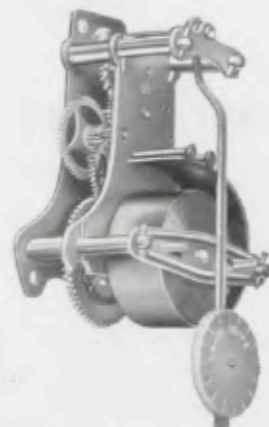

Platinen — Plates — Platines — Platinas
7 x 6 cm = 2 7/8 x 2 1/4 inches

Werk Rap 8 Tag Pendelgehwerk
8 day pendulum time movement
Mouvement 8 jours simple à balancier
Máquina 8 días cuerda á péndola



Einsatzuhren zum Einbauen in Möbel, Büfets usw.

Dial clocks for fitting in furniture, sideboards etc. — Pendules à encastrer pour meubles, buffets etc. — Relojes para colocar en estantes, muebles etc.



18/181

18/1
18/182

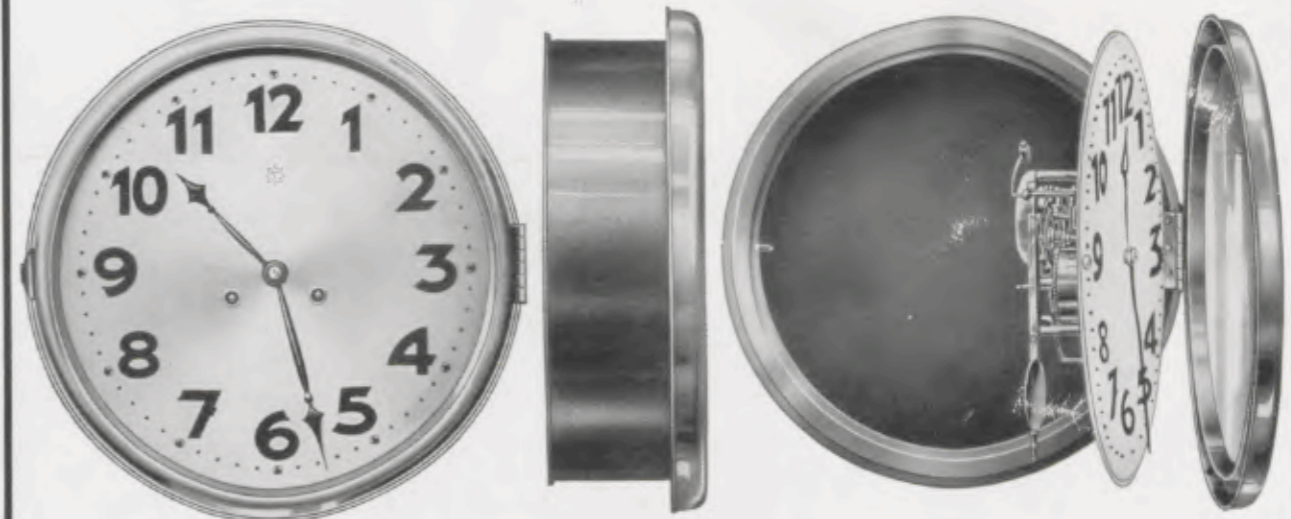

18/2

18/181 8 Tag Ankergehwerk No. 146 — 8 day lever time — 8 jours simple à ancre — 8 días cuerda, escape á áncora
18/1 14 Tag Pendelgehwerk — 14 day pendulum time — 15 jours simple à balancier — Máquina á péndola, 15 días cuerda
18/182 8 Tag Ankergehwerk No. 146 — 8 day lever time — 8 jours simple à ancre — 8 días cuerda, escape á áncora
18/2 14 Tag Pendelgehwerk — 14 day pendulum time — 15 jours simple à balancier — Máquina á péndola, 15 días cuerda

Chromlunetten — Chromium plated bezels — Lunettes chromées — Biseles cromados

Abmessungen — Dimensions — Dimensions — Dimensiones

No.	Silberblatt — Silver dial — Cadran argenté — Esfera plateada		Hintergehäuse — Back case — Tambour — Caja	
	Minutenkreisdurchmesser Diameter of minute circle Diamètre du cercle minutes Diámetro del círculo de minutos	Lunettendurchmesser Diameter of bezel Diamètre extér. de la lunette Diámetro total del bisel	Durchmesser Diameter Diamètre Diámetro	Tiefe Depth Profondeur Profundidad
18/181	164 mm = 6 1/2 inches	210 mm = 8 1/4 inches	180 mm = 7 inches	63 mm = 2 1/2 inches
18/1	225 .. = 9 ..	275 .. = 10 7/8 ..	232 .. = 9 1/8 ..	80 .. = 3 1/8 ..
18/182	225 .. = 9 ..	275 .. = 10 7/8 ..	232 .. = 9 1/8 ..	80 .. = 3 1/8 ..
18/2	262 .. = 10 ..	332 .. = 13 1/8 ..	280 .. = 11 ..	80 .. = 3 1/8 ..



Agnes



Glazifferblatt
Glass dial - Cadran verre - Esfera de vidrio

Rahmen - Frame - Cadre - Marco		Zifferblatt - Dial - Cadran - Esfera	
Buche hell poliert Light beech polished Hêtre clair poli Haya clara pulida	Nußbaumfarbig Walnut finish Teinte noyer Color nogal	Durchmesser Diameter Diamètre Diámetro	Minutenkreisdurchmesser Diameter of minute circle Diamètre du cercle minutes Diámetro del círculo de minutos
18/202	18/203	276 = 11 mm inches	184 = 7 mm inches
18/204	18/206	8 Tag Pendelgehwerk - 8 day pendulum time - 8 jours simple à balancier - 8 días cuerda á péndola	
		14 Tag Gehwerk - 14 day time - 15 jours simple - 15 días cuerda	
18/208	18/210	315 = 12 ¹ / ₂ mm inches	216 = 8 ¹ / ₂ mm inches
		14 Tag Gehwerk - 14 day time - 15 jours simple - 15 días cuerda	
18/212		364 = 14 ¹ / ₄ mm inches	262 = 10 mm inches
		14 Tag Gehwerk - 14 day time - 15 jours simple - 15 días cuerda	

18/202-203: mit Blechhinterkasten - with metal case - avec boîte en tôle - con caja de metal



Altai



Zelluloid-Zifferblatt, bombiertes Glas
Celluloid dial, convex glass - Cadran celluloid, verre bombé - Esfera de celuloide, cristal bombeado

Rahmen - Frame - Cadre - Marco			Zifferblatt - Dial - Cadran - Esfera	
Buche hell poliert Light beech polished Hêtre clair poli Haya clara pulida	Nußbaumfarbig Walnut finish Teinte noyer Color nogal	Weiß lackiert White lacquered Verni blanc Barnizado en blanco	Durchmesser Diameter Diamètre Diámetro	Minutenkreisdurchmesser Diameter of minute circle Diamètre du cercle minutes Diámetro del círculo de minutos
18/216	18/217		276 = 11 mm inches	184 = 7 mm inches
18/218	18/220	18/235	8 Tag Pendelgehwerk - 8 day pendulum time - 8 jours simple à balancier - 8 días cuerda á péndola	
			14 Tag Gehwerk - 14 day time - 15 jours simple - 15 días cuerda	
18/222	18/224		315 = 12 ¹ / ₂ mm inches	216 = 8 ¹ / ₂ mm inches
			14 Tag Gehwerk - 14 day time - 15 jours simple - 15 días cuerda	
18/226			364 = 14 ¹ / ₄ mm inches	262 = 10 mm inches
			14 Tag Gehwerk - 14 day time - 15 jours simple - 15 días cuerda	

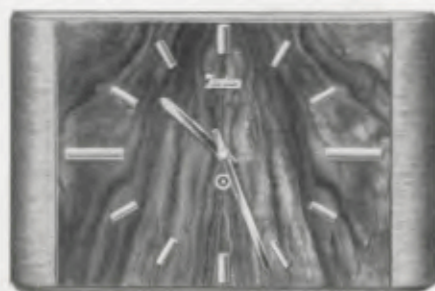

22 x 34 cm = 8 7/8 x 13 3/8 inches

18/260 Eiche mit polierter Nußbaum-Vorderplatte
Oak with polished walnut
Chêne avec noyer poli
Roble con nogal pulido

Verchromte Striche und Zeiger
Chromium plated strokes and hands
Barres et aiguilles chromées - Rayas
y agujas cromadas

8 Tag Pendelgehwerk Rap - 8 day pendulum time movement Rap - Mouvement
8 jours simple à balancier Rap - Máquina 8 días cuerda a péndola Rap



23 x 29 cm = 9 x 11 1/2 inches

18/261 Eiche mit Nußbaum poliert - Oak with
polished walnut - Chêne avec noyer
poli - Roble con nogal pulido

Verchromte Zahlen und Zeiger
Chromium plated figures and hands
Chiffres et aiguilles chromés - Cifras
y agujas cromadas



24,5 x 37 cm = 9 3/4 x 14 1/2 inches

18/272 Kaukas. Nußbaum poliert mit Schleiflack,
elfenbeinfarbig - Polished Caucasian
walnut with varnished ivory dull - Noyer
Caucasien poli avec peinture ivoire
laquée dépolie - Nogal Caucaso pulido
con barniz pulido mate, marfil

Schwarze Striche und Zeiger - Black
strokes and hands - Barres et aiguilles
noires - Rayas y agujas negras

Ladenpreis.....RM. 38.-

8 Tag Ankergehwerk mit Echappement - 8 day lever time movement with escapement
8 jours simple, échappement à ancre - Máquina 8 días cuerda, escape à ancora



30 cm = 11 3/4 inches
Profil siehe Seite 75

Verchromtes Gehäuse - Chromium plated case
Boîte chromée - Caja cromada

18/259 Z Zahlen - Figures - Chiffres - Cifras
18/259 S Striche - Strokes - Barres - Rayas

Ladenpreis.....RM. 45.-
Zifferblatt kaukas. Nußbaum poliert
Dial polished Caucasian walnut
Cadran noyer Caucasien poli
Esfera nogal Caucaso pulido

18/271 Z Zahlen - Figures - Chiffres - Cifras

Ladenpreis.....RM. 35.-

Zifferblatt Eiche - Oak dial - Cadran
chêne - Esfera roble



18,5 x 25,5 cm = 7 1/4 x 10 inches

18/276



18,5 x 25,5 cm = 7 1/4 x 10 inches

18/277



22 x 28,5 cm = 8 3/4 x 11 1/4 inches

18/278



22 x 28,5 cm = 8 3/4 x 11 1/4 inches

18/279



22 x 28,5 cm = 8 3/4 x 11 1/4 inches

18/280

Polierte Zahlen und Zeiger
Polished figures and hands
Chiffres et aiguilles polis
Cifras y agujas pulidas

8 Tag Pendelgehwerk - 8 day pendulum time movement
Mouvement 8 jours simple à balancier - Máquina 8 días cuerda a péndola



22 x 20,5 cm = 8 7/8 x 11 1/4 inches

18/281

Polierte Zahlen und Zeiger - Polished figures and hands - Chiffres et aiguilles polis - Cifras y agujas pulidas



22 x 20,5 cm = 8 7/8 x 11 1/4 inches



22 x 20,5 cm = 8 7/8 x 11 1/4 inches

18/283

Polierte Zahlen und Zeiger - Polished figures and hands - Chiffres et aiguilles polis - Cifras y agujas pulidas

8 Tag Pendelgehwerk - 8 day pendulum time movement
Mouvement 8 jours simple à balancier - Máquina 8 días cuerda á péndola



24,5 x 37 cm = 9 3/4 x 14 1/2 inches

18/275

Schwarze Zahlen und Zeiger
Black figures and hands
Chiffres et aiguilles noirs
Cifras y agujas negras

8 Tag Pendelgehwerk Rap - 8 day pendulum time movement Rap
Mouvement 8 jours simple à balancier Rap - Máquina 8 días cuerda á péndola Rap



24 x 24 cm = 9 1/2 x 9 1/2 inches

18/268

Schwarze Zahlen und Zeiger
Black figures and hands
Chiffres et aiguilles noirs
Cifras y agujas negras



24 x 24 cm = 9 1/2 x 9 1/2 inches

18/269

Matte Zahlen und Zeiger
Mat figures and hands
Chiffres et aiguilles mats
Cifras y agujas mate



24 x 24 cm = 9 1/2 x 9 1/2 inches

18/270

Buche-Rahmen - Beech frame
Cadre en hêtre - Marco haya

Schwarze Zahlen und Zeiger
Black figures and hands
Chiffres et aiguilles noirs
Cifras y agujas negras

8 Tag Pendelgehwerk - 8 day pendulum time movement
Mouvement 8 jours simple à balancier - Máquina 8 días cuerda á péndola



22 x 29 cm = 8 1/2 x 11 1/2 inches

18/250



22 x 29 cm = 8 1/2 x 11 1/2 inches

18/252



22 x 29 cm = 8 1/2 x 11 1/2 inches

18/251

18/274 Z Verchromte Zahlen und Zeiger - Chromium plated figures and hands
Chiffres et aiguilles chromées - Cifras y agujas cromadas

18/274 S Verchromte Striche und Zeiger - Chromium plated strokes and hands
Barres et aiguilles chromées - Rayas y agujas cromadas

Schleiflackgehäuse - Lacquered cases
Cages laquées dépolies - Cajas barniz pulido mate

8 Tag Pendelgehwerk Rap - 8 day pendulum time movement Rap
Mouvement 8 jours simple à balancier Rap - Máquina 8 días cuerda à péndola Rap



25 x 30 cm = 9 1/2 x 11 1/2 inches

18/248

Schleiflackgehäuse - Lacquered case
Cage laquée dépolie - Caja barniz pulido mate

Verchromte Zahlen und Zeiger - Chromium plated figures and hands
Chiffres et aiguilles chromés - Cifras y agujas cromadas

Ladenpreis RM. 22.50

8 Tag Ankergehwerk mit Echappement - 8 day lever time with escapement
8 jours simple, échappement à ancre - Máquina 8 días cuerda, escape à ancora



22 x 29 cm = 8 1/2 x 11 1/2 inches

18/253

Polierte Zahlen und Zeiger
Polished figures and hands
Chiffres et aiguilles polis
Cifras y agujas pulidas

Ladenpreis RM. 17.-

Schleiflack mit Birkenmaserleiste - Lacquered cases with bur birch
Cages laquées dépolies avec loupe de bonleau - Cajas barniz pulido mate con abedul negro

8 Tag Pendelgehwerk Rap - 8 day pendulum time movement Rap
Mouvement 8 jours simple à balancier Rap - Máquina 8 días cuerda à péndola Rap



25 x 30 cm = 9 1/2 x 11 1/2 inches

18/254

Verchromte Zahlen und Zeiger
Chromium plated figures and hands
Chiffres et aiguilles chromés
Cifras y agujas cromadas

Ladenpreis RM. 22.50



22 x 33 cm = 8 7/8 x 13 inches

- 18/263 Zahlen - Figures - Chiffres - Cifras
 18/266 Striche - Strokes - Barres - Rayas



22 x 33 cm = 8 7/8 x 13 inches

- 18/264 Zahlen - Figures - Chiffres - Cifras
 18/267 Striche - Strokes - Barres - Rayas

Ladenpreis RM. 20.—



22 x 33 cm = 8 7/8 x 13 inches

- 18/265 Zahlen - Figures - Chiffres - Cifras

Ladenpreis RM. 20.—

Schleiflackgehäuse - Lacquered cases - Cages laquées dépolies
 Cajas barniz pulido mate

8 Tag Pendelgehwerk Rap - 8 day pendulum time movement Rap
 Mouvement 8 jours simple à balancier Rap - Máquina 8 días cuerda a péndola Rap



30 cm = 11 3/4 inches

- 18/255 Z Zahlen - Figures - Chiffres
 Cifras
 18/255 S Striche - Strokes - Barres
 Rayas
 Ladenpreis RM. 35.—



30 cm = 11 3/4 inches

- 18/256 Z Zahlen - Figures - Chiffres
 Cifras
 18/256 S Striche - Strokes - Barres
 Rayas
 Ladenpreis RM. 35.—

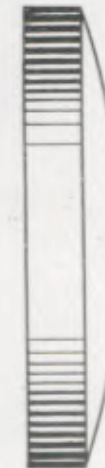

30 cm = 11 3/4 inches

- 18/257 Z Zahlen - Figures - Chiffres
 Cifras
 18/257 S Striche - Strokes - Barres
 Rayas
 Ladenpreis RM. 35.—



30 cm = 11 3/4 inches

- 18/258 Z Zahlen - Figures - Chiffres
 Cifras
 18/258 S Striche - Strokes - Barres
 Rayas
 Ladenpreis RM. 35.—

Verchromte Gehäuse mit Schleiflackfront - Chromium plated cases with lacquered front
 Cages chromées avec cadran laqué dépoli - Cajas cromadas con esfera barniz pulido mate

8 Tag Ankergehwerk mit Echappement - 8 day lever time movement with escapement
 8 jours simple, échappement à ancre - Máquina 8 días cuerda, escape a áncora



**„Sie“ kann sich auf ihre
Küchenuhr verlassen!**

Es ist eine Junghans! — Ihre Zeiger hüten wie mahnende Finger die Innehaltung der Mahlzeiten und sorgen so für Pünktlichkeit und Ordnung, nicht nur in der Küche, sondern im ganzen Haushalt. Neben dem Wecker ist die Küchenuhr die wichtigste Uhr im jungen Haushalt. Um so notwendiger daher ist ein reichhaltiges Lager darin, besonders wenn Sie an die nunmehr wachsende Zahl der Eheschließungen denken. Bevorzugen Sie dabei die neuen Junghans-Küchenuhren in Steingut. Es sind hübsche, gefällige Formen, entweder schlicht-weiß oder mit frischen, sauberen Farben. Dies und die teilweise sehr niedrigen Preise eröffnen Ihnen leichten Verkauf.



GRUPPE 19

Küchenuhren in Steingut

Kitchen and Nursery Clocks in earthenware cases – Pendules pour cuisine, cages en faïence – Relojes para cocina, cajas en loza



20 cm – 7 7/8 inches

19/342



20 cm – 7 7/8 inches

19/344



20 cm – 7 7/8 inches

19/346

1 Tag Ankergehwerk – 1 day lever time movement
Mouvement 30 heures simple à ancre – Máquina 30 horas á âncora

19/343

19/345

19/347

8 Tag Pendelgehwerk – 8 day pendulum time movement
Mouvement 8 jours simple à balancier – Máquina 8 días cuerda á péndola



20 x 24 cm – 8 x 9 1/2 inches

19/352



20 x 24 cm – 8 x 9 1/2 inches

19/354



20 x 24 cm – 8 x 9 1/2 inches

19/365

1 Tag Ankergehwerk – 1 day lever time movement
Mouvement 30 heures simple à ancre – Máquina 30 horas cuerda á âncora

19/353

19/355

19/366

8 Tag Pendelgehwerk Rap – 8 day pendulum time movement Rap
Mouvement 8 jours simple à balancier Rap – Máquina 8 días cuerda á péndola Rap

Geschlossene Kapsel – Closed back-case – Capsule fermée – Cápsula cerrada



20 x 24 cm – 8 x 9 1/2 inches

19/368

1 Tag Ankergehwerk
1 day lever time movement
Mouvement 30 heures simple à ancre
Máquina 30 horas cuerda á âncora

19/369

8 Tag Pendelgehwerk Rap
8 day pendulum time movement Rap
Mouvement 8 jours simple à balancier Rap
Máquina 8 días cuerda á péndola Rap



24 cm – 9 1/2 inches

19/318

LadenpreisRM. 9. –



24 cm – 9 1/2 inches

19/319

LadenpreisRM. 9. –

8 Tag Pendelgehwerk
8 day pendulum time movement
Mouvement 8 jours simple à balancier
Máquina 8 días cuerda á péndola



24 cm – 9 1/2 inches

19/348



24 cm – 9 1/2 inches

19/349



24 cm – 9 1/2 inches

19/367

8 Tag Pendelgehwerk – 8 day pendulum time movement
Mouvement 8 jours simple à balancier – Máquina 8 días cuerda á péndola

Geschlossene Kapsel – Closed back-case – Capsule fermée – Cápsula cerrada



24 cm = 9 1/2 inches

19/340

LadenpreisRM. 9.—



24 cm = 9 1/2 inches

19/370

LadenpreisRM. 9.—



24 cm = 9 1/2 inches

19/371

LadenpreisRM. 9.—

8 Tag Pendelgehwerk - 8 day pendulum time movement
Mouvement 8 jours simple à balancier - Máquina 8 días cuerda á péndola



20 x 26 cm = 8 x 10 1/4 inches

19/357



20 x 26 cm = 8 x 10 1/4 inches

19/358

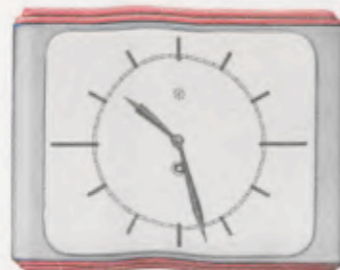

20 x 26 cm = 8 x 10 1/4 inches

19/359 Z Zahlen - Figures - Chiffres - Cifras

19/359 S Striche - Strokes - Barres - Rayas

LadenpreisRM. 9.—

8 Tag Pendelgehwerk Rap - 8 day pendulum time movement Rap
Mouvement 8 jours simple à balancier Rap - Máquina 8 días cuerda á péndola Rap

19/361

LadenpreisRM. 15.—

19/362

LadenpreisRM. 15.—

19/363 Z Zahlen - Figures - Chiffres - Cifras

19/363 S Striche - Strokes - Barres - Rayas

LadenpreisRM. 15.—

Sehr flaches 8 Tag Ankergehwerk - Very flat 8 day lever time movement
Mouvement très plat, 8 jours simple à ancre - Máquina muy plana de 8 días cuerda á áncora

Geschlossene Kapsel - Closed back-case - Capsule fermée - Cápsula cerrada



20 x 26 cm = 8 x 10 1/4 inches

19/360 Z Zahlen - Figures - Chiffres - Cifras

19/360 S Striche - Strokes - Barres - Rayas

LadenpreisRM. 9.—

8 Tag Pendelgehwerk Rap
8 day pendulum time movement Rap
Mouvement 8 jours simple à balancier Rap
Máquina 8 días cuerda á péndola Rap

19/364 Z Zahlen - Figures - Chiffres - Cifras

19/364 S Striche - Strokes - Barres - Rayas

LadenpreisRM. 15.—

Sehr flaches 8 Tag Ankergehwerk
Very flat 8 day lever time movement
Mouvement très plat, 8 jours simple à ancre
Máquina muy plana de 8 días cuerda á áncora



24 cm = 9 1/2 inches

19/350

Ladenpreis RM. 13.50



24 cm = 9 1/2 inches

19/351

Ladenpreis RM. 13.50

Sehr flaches 8 Tag Ankergehwerk
Very flat 8 day lever time movement
Mouvement très plat, 8 jours simple à ancre
Máquina muy plana de 8 días cuerda á áncora



20 x 20 cm = 11 x 11 inches

19/372

LadenpreisRM. 10.—

8 Tag Pendelgehwerk - 8 day pendulum time movement
Mouvement 8 jours simple à balancier - Máquina 8 días cuerda á péndola
Geschlossene Kapsel - Closed back-case - Capsule fermée - Cápsula cerrada



20 x 20 cm = 11 x 11 inches

19/373



Rahmen - Frame
Cadre - Marco
21,5 cm = 8½ inches



20 4



20 5

Ladenpreis.....RM. 17.50

1 Tag Schlagwerk auf Glocke
1 day strike on bell
30 heures sonnerie sur cloche
30 horas sonería sobre campana

Rahmen nußbaumfarbig, Glaszifferblatt - Frame walnut finish, glass dial
Cadre teinte noyer, cadran verre - Marco color nogal, esfera de vidrio

Messing-Garnitur - Brass fittings - Garniture laiton - Orladura de latón



Rahmen - Frame
Cadre - Marco
21,5 cm = 8½ inches



20 6 Zahlen - Figures - Chiffres - Cifras
20 7 Striche - Strokes - Barres - Rayas



20 8 Zahlen - Figures - Chiffres - Cifras
20 9 Striche - Strokes - Barres - Rayas

1 Tag Schlagwerk auf Glocke
1 day strike on bell
30 heures sonnerie sur cloche
30 horas sonería sobre campana

Holz-Rahmen, matt lackiert, Glaszifferblatt - Wooden frame, mat lacquered, glass dial
Cadre en bois, laqué mat, cadran verre - Marco de madera, barnizado mate, esfera de vidrio

Messing-Garnitur - Brass fittings - Garniture laiton - Orladura de latón



GRUPPEN 23, 24, 25

Wanduhren

Regulators - Régulateurs - Reguladores

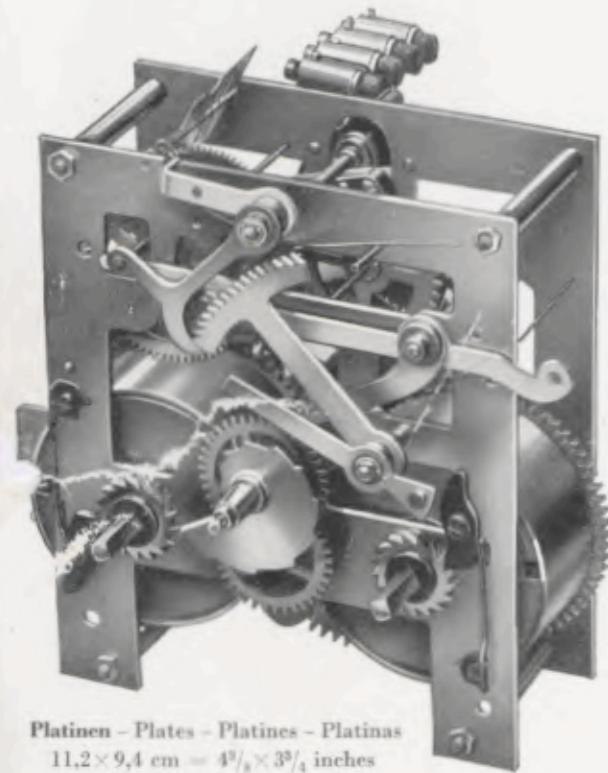

No. 202 A

14 Tag Halbstund-Rechenschlagwerk auf Gong und Bim Bam - Neue zweckmäßige Hammerhebung - Voller, schöner Schlag durch neue Hammeranordnung - Herausnehmbare Federhäuser - Die zweckmäßige Konstruktion erlaubt leichtes Reparieren

14 day half-hour rack-strike movement on Gong and Bim Bam - New efficacious hammer-lifting - Full, nice strike by new arrangement of hammers - Interchangeable spring barrels - Easy to repair

Mouvement à rateau 15 jours sonnerie heures et demies sur Gong et Bim Bam - Elévation nouvelle et pratique des marteaux - Sonnerie pleine et belle grâce à une nouvelle disposition des marteaux - Barillets interchangeables - Facile à réparer

Máquina á sierra 15 días sonería horas y medias sobre Gong y Bim Bam - Elevación nueva y práctica de los martillos - Sonería plena y bonita que se ha obtenido por medio de una nueva disposición de los martillos Barilletes intercambiables - Se deja reparar facilmente

Platinen - Plates - Platines - Platinas
11,2 x 9,4 cm = 4³/₈ x 3³/₄ inches

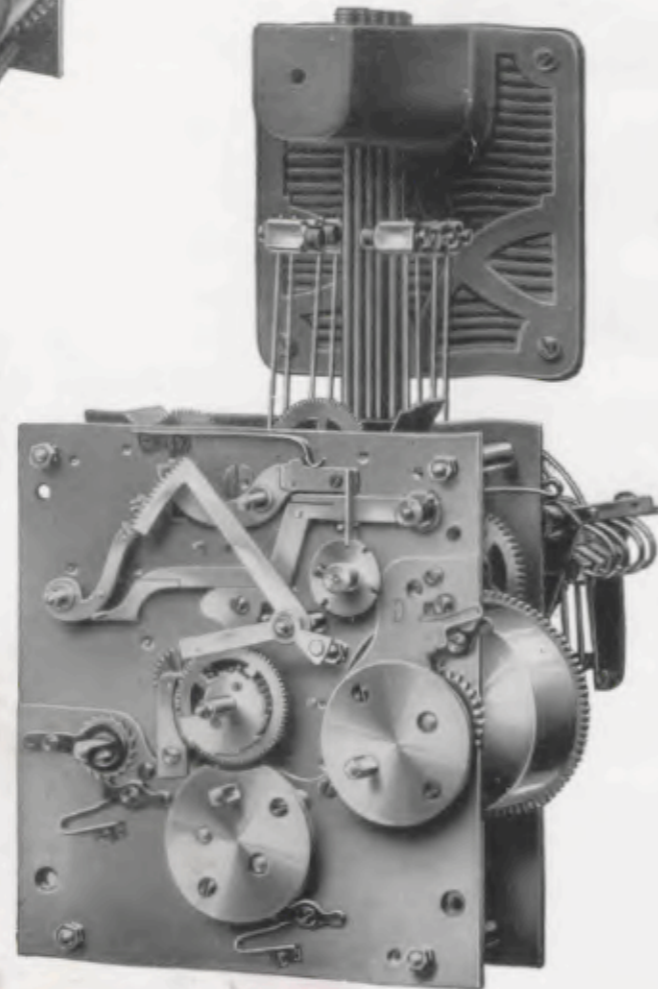

No. 103

Platinen - Plates - Platines - Platinas
14,5 x 13,5 cm = 5⁷/₈ x 5¹/₄ inches

8 Tag ¹/₄ Westminster-Schlagwerk No. 103 mit 5 Stäben - 8 day ¹/₄ Westminster chime movement No. 103 with 5 rodgongs
8 jours sonnerie ¹/₄ Carillon Westminster sur 5 tiges, mouvement No. 103 - 8 días sonería ¹/₄ Carillon Westminster sobre 5 varillas, máquina No. 103



Norden



52 x 26 cm = 20¹/₂ x 10¹/₄ inches

23/81 B Eiche - Oak - Chêne - Roble
Gewöhnliche Gläser - Plain glasses
Verres simples - Vidrios ordinarios

23/83 B Eiche - Oak - Chêne - Roble
Facettegläser - Bevelled glasses
Glaces biseautées - Vidrios biselados

Silberblatt - Silver dial
Cadran argenté - Esfera plateada
14,5 cm = 5³/₄ inches

14 Tag ¹/₂ Stund-Schlagwerk, Bachgong
14 day ¹/₂ hour strike, Gong „Bim Bam“
15 jours sonnerie, heures et demies, Gong „Bim Bam“
15 días sonería, horas y medias, Gong „Bim Bam“

In Eiche roh, 40 und 45 lieferbar

Neu-Bruck I



54,5 x 25,5 cm = 21¹/₂ x 10 inches

23/88 B Eiche - Oak - Chêne - Roble

Silberblatt
Silver dial
Cadran argenté
Esfera plateada
15 cm = 6 inches



Neu-Bruck II



54,5 x 25,5 cm = 21 1/2 x 10 inches

23/90 B Eiche - Oak - Chêne - Roble

14 Tag 1/2 Stund-Schlagwerk, Bachgong
 14 day 1/2 hour strike, Gong „Bim Bam“
 15 jours sonnerie, heures et demies, Gong „Bim Bam“
 15 días sonería, horas y medias, Gong „Bim Bam“

Silberblatt - Silver dial - Cadran argenté - Esfera plateada 15 cm = 6 inches

In Eiche roh, 40 und 45 lieferbar

Neu-Bruck III



54,5 x 25,5 cm = 21 1/2 x 10 inches

23/92 B Eiche - Oak - Chêne - Roble



52 x 29 cm = 20 1/2 x 11 inches

24/126 Eiche - Oak - Chêne - Roble

1 Tag Schlagwerk auf Tonfeder
 1 day strike on plain strike
 30 heures sonnerie sur ressort timbre
 30 horas sonería sobre bordón

24/127 Eiche - Oak - Chêne - Roble

8 Tag 1/2 Stund-Schlagwerk, Tonfeder
 oder Bachgong - 8 day 1/2 hour strike,
 plain strike or Gong „Bim Bam“
 8 jours sonnerie, heures et demies, ressort
 timbre ou Gong „Bim Bam“ - 8 días
 sonería, horas y medias, sonería sobre
 bordón ó sonería sobre Gong „Bim Bam“

Silberblatt - Silver dial - Cadran argenté - Esfera plateada 18 cm = 7 inches

In Eiche roh, 40 und 45 lieferbar



55 x 28 cm = 21 1/2 x 11 inches

24/119 Eiche - Oak - Chêne - Roble

14 Tag 1/2 Stund-Schlagwerk, Tonfeder
 oder Bachgong - 14 day 1/2 hour strike,
 plain strike or Gong „Bim Bam“
 15 jours sonnerie, heures et demies, res-
 sort timbre ou Gong „Bim Bam“
 15 días sonería, horas y medias, sonería
 sobre bordón ó sonería sobre Gong
 „Bim Bam“



Gossau I und II



63,5 x 31,5 cm = 25 x 12 1/4 inches

24/111 B Eiche - Oak - Chêne - Roble

Gewöhnliche Gläser - Plain glasses
Verres simples - Vidrios ordinarios

24/113 B Eiche - Oak - Chêne - Roble

24/114 B Nußbaum - Walnut - Noyer - Nogal

Facettegläser - Bevelled glasses
Glaces biseautées - Vidrios biselados

Bachgong - Gong „Bim Bam“

Zifferblatt - Dial - Cadran - Esfera 18 cm = 7 inches

Eichengehäuse in Eiche roh, 40 und 45 lieferbar



Überlingen II



65 x 31 cm = 25 1/2 x 12 1/4 inches

24/122 B

Eiche - Oak - Chêne - Roble

Bachgong - Gong „Bim Bam“

Zifferblatt - Dial - Cadran - Esfera 18 cm = 7 inches

In Eiche roh, 40 und 45 lieferbar

Überlingen IV



65 x 31 cm = 25 1/2 x 12 1/4 inches

24/124 B



15

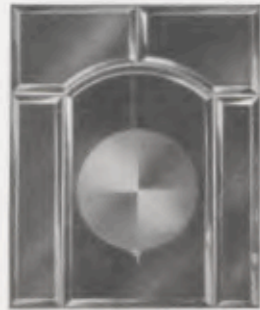

141

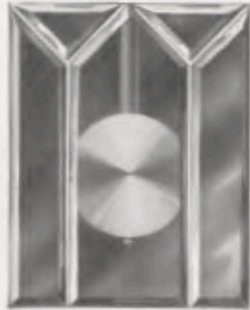

188

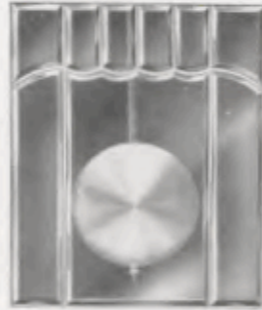

189



145



Die Regulateure der Gruppe 25 mit rechteckigen Verglasungen können auch mit den hier abgebildeten Messingverglasungen geliefert werden.

The regulators of group 25 fitted with square brass frames can also be had with the above shown fittings.

Les régulateurs de la série 25 avec panneaux de glaces carrées peuvent être fournis avec les panneaux de glaces serties en laiton suivant gravures ci-dessus.

Los reguladores del grupo 25 con vidrieras rectangulares se montan además con las vidrieras de los dibujos, que se ven más arriba.



Kassel I und II



78 x 33 cm = 30 3/4 x 13 inches

25 466 B Eiche - Oak - Chêne - Roble

Gewöhnliche Gläser - Plain glasses
Verres simples - Vidrios ordinarios

25 468 B Eiche - Oak - Chêne - Roble

Facettegläser - Bevelled glasses
Glaces biseautées - Vidrios biselados

Zifferblatt - Dial - Cadran
Esfera 18 cm = 7 inches

Bachgong - Gong „Bim Bam“

In Eiche roh, 40 und 45 lieferbar

Kiel I



78 x 33 cm = 30 3/4 x 13 inches

25 368 B Eiche - Oak - Chêne - Roble

Zifferblatt - Dial - Cadran
Esfera 20,5 cm = 8 inches



Kiel II



78 x 33 cm = 30 3/4 x 13 inches

25/370 B Eiche - Oak - Chêne - Roble

Kiel IV



78 x 33 cm = 30 3/4 x 13 inches

25/372 B Eiche - Oak - Chêne - Roble

Bachgong

Zifferblatt - Dial - Cadran - Esfera 20,5 cm = 8 inches

In Eiche roh, 40 und 45 lieferbar



Lüneburg II



78 x 33 cm = 30 3/4 x 13 inches

25/486 B Eiche - Oak - Chêne - Roble

Lüneburg IV



78 x 33 cm = 30 3/4 x 13 inches

25/487 B Eiche - Oak - Chêne - Roble

25/488 B Nußbaum - Walnut - Noyer
Nogal

Bachgong

Zifferblatt - Dial - Cadran - Esfera 20,5 cm = 8 inches

Eichengehäuse in Eiche roh, 40 und 45 lieferbar



Lauenburg II



78 x 33 cm = 30 3/4 x 13 inches

25/491 B Eiche - Oak - Chêne - Roble

Lauenburg IV



78 x 33 cm = 30 3/4 x 13 inches

25/492 B Eiche - Oak - Chêne - Roble

Bachgong - Gong „Bim Bam“

Zifferblatt - Dial - Cadran - Esfera 20,5 cm = 8 inches

In Eiche roh, 40 und 45 lieferbar



Oldenburg I



78 x 33 cm = 30 3/4 x 13 inches

25/494 B

Eiche - Oak - Chêne - Roble

Bachgong

Zifferblatt - Dial - Cadran - Esfera 20,5 cm = 8 inches

In Eiche roh, 40 und 45 lieferbar



Stellen Sie sich einmal diese Wanduhr vor!

Nicht wahr, haben Sie sich schon für eine moderne Wanduhr. Sagen Sie auch Ihren Kunden. Zeigen Sie ihnen, wie schön und zweckmäßig die moderne Wanduhr ist, die sogar die Möbel gewissermaßen zusammenfaßt. Und halten Sie dazu auch Jungfern am Lager. Besonders unsere modernen Modelle werden Ihnen dann helfen, beim Publikum eine neue Liebe für Wanduhren zu wecken, zumal die Preise sehr wohlfeil sind.

Junghans



GRUPPE 27

Aparte Wanduhren für die moderne Wohnung

Smart wall clocks for the modern home - Pendules art nouveau pour intérieurs modernes
Relojes de pared especiales para la casa moderna

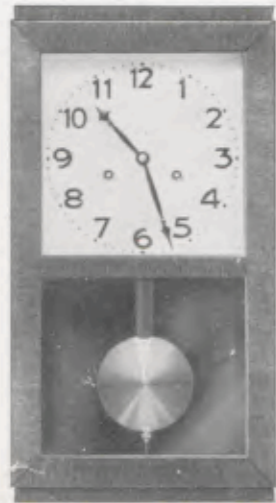

45 x 24 cm = 18 x 9 1/2 inches



52 x 26 cm = 20 1/2 x 10 1/4 inches

7/16 B Eiche - Oak - Chêne - Roble

27/17 B Nußbaum poliert - Polished walnut - Noyer poli
Nogal pulido

Goldblatt - Gilt dial - Cadran doré - Esfera dorada
18 x 18 cm = 7 x 7 inches

27/18 B Eiche - Oak - Chêne - Roble

Silberblatt - Silver dial - Cadran argenté - Esfera
plateada 20 x 20 cm = 8 x 8 inches

Bachgong „Bim Bam“ 3 Stäbe



57,5 x 31,5 cm = 22 3/4 x 12 3/8 inches

27 Eiche mit Nußbaumtür - Oak with wa/
Chêne avec porte en noyer - Roble con puer

7/28 Nußbaum - Walnut - Noyer - Nogal

Silberzahlenreif, verchromte Zahlen und Zeige.
Silvered figure-circle, chromium plated figures and hands
Cercle à chiffres argenté, chiffres et aiguilles chromés
Cerclo de cifras plateado, cifras y agujas cromadas

Bachgong „Bim Bam“

Eichengehäuse in Eiche roh, 40 und 45 lieferbar



52 x 26 cm = 20 1/2 x 10 1/4 inches

- Chêne - Roble

Silberblatt - Dial - Cadran - Esfera
cu = 9 inches

