

# Jungheims

Muster  
Zimmerman



HAUPTKATALOG 1932



**UHRENFABRIKEN**

Watch- and Clock Factories — Fabriques d'horlogerie — Fábricas de relojes

*Gebrüder Junghans*

**A.-G.**

**SCHRAMBERG**

Schwarzwald — Black-Forest — Forêt-Noire — Selva negra



## Gruppen-Verzeichnis

Index of Groups \* Index des groupes \* Indice por grupos

Gruppe		Page	Gruppe		Page					
4	Kleinste Qualitäts-Wecker Smallest highclass quality alarms Réveils miniature de qualité supérieure Despertadores miniatura de calidad superior	5	18	Bürouhren - Rundrahmehhren Dial clocks - Office clocks Ceils de Bœuf - Pendules pour bureaux Relojes de pared y para despachos	51					
						5	6	19	Küchenuhren Kitchen clocks Pendules pour cuisine Relojes de cocina	61
8	Wecker in Metall- und Holzgehäusen Alarm clocks in metal and wooden cases Réveils en boîtes métal et bois Despertad y de made	20 32	27	Moderne Wanduhren Art regulators Régulateurs modernes Reguladores estilo moderno	86					
						9	16	28	Dielenuhren Hall clocks Horloges de parquet Relojes de recibidor	
10	Schreibtischgehwerk Writing t Pendulet Relojes p				28					
						17	Kaminul Mantle c Pendule Relojes			



## Nummern-Verzeichnis

Index of numbers \* Index des numéros \* Indice por números

Nº	Seite Page	Nº	Seite Page	Nº	Seite Page
4/48-49	8	7/160	19	14/23	35
4/51	8	7/171-172	19	14/121-122	35
4/69 RZ	5	7/195-196	19	17/296	43
4/101	8	7/321-322	19	17/432	39
4/106	8	8/2	21	17/459	43
4/108-109 RZ	6	8/9	31	17/509	44
4/119 RZ	5	8/15-25	31	17/516	37
4/144 RZ	5	8/35-40	31	17/528	42
4/170 RZ	6	8/45	21	17/534-536	50
4/175-176 RZ	5	8/99-100	21	17/540-541	37
4/180 RZ	6	8/184	23	17/542-543	38
4/182 RZ	6	8/188	28	17/544-545	39
4/195 a	6	8/190-191	22	17/546	40
4/282 RZ	5	8/197-205	23	17/547	41
4/284-286 RZ	6	8/206-208	24	17/548-549	42
4/291-292 RZ	5	8/209-211	23	17/550	40
4/295 RZ	5	8/213-216	24	17/552-553	44
4/299-300 RZ	6	8/217-219	25	17/554	46
4/301-304 RZ	5	8/220-222	23	17/556-557	46
4/305-308 RZ	6	8/223-224	24	17/559	47
4/309-310 RZ	5	8/225-227	24	17/562	48
4/311 RZ	6	8/228	22	17/563-564	49
4/312-314 RZ	7	8/233	23	17/565	50
5/178-179	9	8/234-236	21	17/566	49
5/180-181	11	8/242	21	17/567	48
5/184-185	9	8/266-267	26	17/568	45
5/188-189	11	8/270-273	26	17/569	41
5/190	10	8/276-278	22	17/570	45
5/193-194	11	8/284-285	26	17/571	46
5/195-197	9	8/293-295	25	17/572	45
5/198	10	8/301-302	27	17/575-576	47
5/199	11	8/307-308	24	17/577	48
5/200-202	10	8/309	22	17/578	44
5/203-208	12	9/131-132	32	18/1-3	51
5/209-210	13	10/62-65	33	18/42	60
6/3-6	14	12/1-62	34	18/71	58
6/11-12	14			18/89	60
6/13-16	15			18/91-94	55



Nummern-Verzeichnis - Index of numbers - Index des numéros - Indice por números

N <sup>o</sup>	Seite Page	N <sup>o</sup>	Seite Page	N <sup>o</sup>	Seite Page
18/96	58	24/80	76	54/91	17
18/98	51	24/90-93	75	54/97	17
18/100-103	55	24/95-96	75	54/100-102	17
18/110-111	59	24/111-116	74	54/104-107	17
18/133-148	54			54/119	17
18/169-176	55	25/316-317	85	54/120-121	17
18/181-182	51	25/362-363	82	54/161-163	16
18/199-200	56	25/367-368	79	54/243-247	18
18/202-215	52	25/370-372	79		
18/216-236	53	25/382	80		
18/244-245	56	25/384	80	56/25-26	28
18/246-248	57	25/386	80	56/27	29
		25/390-391	80	56/31	29
19/27-28	64	25/416	81	56/41	29
19/292-294	63	25/418-420	81	56/42	29
19/301	63	25/422	82	56/51-54	30
19/305-311	61	25/426-427	84		
19/312	62	25/432-433	83	101/37 RZ	3
19/313	61	25/466-471	78	101/40-41 RZ	3
19/314-318	62			101/59 RZ	4
19/319-324	63	27/5-6	87	101/61 RZ	4
19/325	62	27/15	88	101/63 RZ	4
19/326-327	63	27/16-19	86	101/65 RZ	4
19/328-333	64	27/20-21	88	101/66 RZ	3
19/335-339	65	27/22-25	87	101/102 RZ	1
		27/26	88	101/106-109 RZ	1
20/4-5	66	27/27-29	86	101/110-112 RZ	2
20/6-9	67			101/113 RZ	1
		28/154-157	89		
21/2-12	68	28/158-159	90		
21/14, 32	69	28/160	91		
21/40, 53	70	28/161	89		
		28/162-163	91		
23/54-55	73	28/164	92		
23/58-60	73	28/166	92		
23/79	72	54/1	16		
23/86-87	72	54/3	16		
		54/11-13	16		



Namen-Verzeichnis

Index of names \* Index des noms \* Indice por nombres

	Seite Page		Seite Page		Seite Page
Afrika	55	Gloria	17	Neu-Triumph	19
Agnes	52	Gossau I	74	Neu-Villach	72
Altai	53	" II	74		
Applaus	17	" IV	74	Oder IV	69
Azur	17	Guatemala III	82	Office	60
Baby	21	Haidarabad	59	Pico	19
Bangalore	59	Hall I	83	Pionier I	24
Boxer	24	" II	83	" II	24
Bravetto	23	Halli I	24	Primus I	16
Bravo	23	" II	25	" II	16
" a. Sockel	23				
" J	23	Jazzo	29	Rangoon	58
Bruck I	73	Joker I	31	Regent I	25
" III	73	" II	31	" II	25
" IV	73	" III	31		
Buenos Aires	54	Isar	70	Samba	29
				Salome	8
Calcutta	58	Kalender	16	Saxonia	6
Colombo	72	Kassel I	78	Sensenschärfer	30
Cœur	5	" II	78	Silent	27
		" IV	78	Soerabaya	60
Darling	6	Kiel I	79	Suevia	6
Delight	19	" II	79	Sula	29
Desk I	16	" IV	79	Sulu	29
" II	16			Splendid	19
		Lloyd II	25	Start	17
Elbe II	70			Stella	21
Elefant	8	Marburg I	85	Schaukel	30
Elegant	8	" II	85	Schmied	30
		Marine	34	Schuster	30
Flensburg I	81	Meersburg	75		
" II	81	Meiringen	76	Teutonia	5
" III	81	Memel II	75	Tommy	22
" IV	82	" III	75	Tölz I	80
Flotte	34	Mosel I	68	" II	80
Forelle	64	" II	68	" V	80
Frankonia	6	" III	68	Turner	28
Fußball	28				
		Neu-Alemannia	5	Weser	69
Gamin	8	Neu-Bravetto	26	World I	34
Geislingen I	84	Neu-Bravo	26	" II	55
" II	84	Neu-Suevia	6	Zumba	28
Globe	22				



GRUPPE 101

Reiseuhren

Travelling watches — Montres de voyage — Relojes para viaje



Durchmesser — Diameter — Diamètre  
Diámetro 6,8 cm — 2 3/4 inches

Kalotte Werk J 62 (ohne Etui) für Etui-Ausschnitt 63 1/2 mm

Calotte movement J 62 (without leather case) for case-opening 63 1/2 mm

Calotte mouvement J 62 (sans écrin) pour ouverture d'écrin de 63 1/2 mm

Máquina completa J 62 (sin estuche) para abertura de estuche de 63 1/2 mm



10,5 x 10,5 cm — 4 1/4 x 4 1/4 inches

**101/102 RZ** Saffian-Schafleder, rotbraun — Brown sheep's skin, morocco grained — Mouton grain maroquin, brun-rouge — Badana taflete, moreno

**101/109 RZ** Saffian-Schafleder, schwarz — Black sheep's skin, morocco grained — Mouton grain maroquin, noir — Badana taflete, negro

**101/113 RZ** Saffian-Schafleder, dunkelbraun — Brown sheep's skin, morocco grained — Mouton grain maroquin, brun — Badana taflete, moreno



10,5 x 10,5 cm — 4 1/4 x 4 1/4 inches

**101/107 RZ** Saffian-Schafleder, rotbraun — Brown sheep's skin, morocco grained — Mouton grain maroquin, brun-rouge — Badana taflete, moreno



10,5 x 10,5 cm — 4 1/4 x 4 1/4 inches

**101/106 RZ** Krokodilimitation, dunkelbraun — Brown crocodile, grained — Crocodile grain, brun — Piel de cocodrilo imitación, moreno



10,5 x 10,5 cm — 4 1/4 x 4 1/4 inches

**101/108 RZ** Saffian-Schafleder, schwarz mit weiß — Sheep's skin, black with white, morocco grained — Mouton grain maroquin, noir avec raies blanches — Badana taflete, negro con rayas blancas

1 Tag Weckerwerk No. J 62 — 1 day alarm movement No. J 62  
30 heures réveil mouvement No. J 62 — 30 horas despertador máquina No. J 62



1,7 x 1,7 cm — 3 x 3 inches

Kalotte viereckig, Werk J 62 (ohne Etui) für Etui-Ausschnitt 61 x 61 mm

Square calotte, movement J 62 (without leather case) for case-opening 61 x 61 mm

Calotte carrée, mouvement J 62 (sans écrin) pour ouverture d'écrin de 61 x 61 mm

Máquina completa J 62 (sin estuche) para abertura de estuche de 61 x 61 mm



10,5 x 10,5 cm — 4 1/4 x 4 1/4 inches

**101/110 RZ** Saffian-Schafleder, braun — Brown sheep's skin, morocco grained — Mouton grain maroquin, brun — Badana taflete, moreno



10,5 x 10,5 cm — 4 1/4 x 4 1/4 inches

**101/111 RZ** Saffian-Schafleder, braun — Brown sheep's skin, morocco grained — Mouton grain maroquin, brun — Badana taflete, moreno



10,5 x 10,5 cm — 4 1/4 x 4 1/4 inches

**101/112 RZ** Saffian-Schafleder, blau mit weiß — Sheep's skin, blue with white, morocco grained — Mouton grain maroquin, bleu avec raies blanches — Badana taflete, azul con rayas blancas

Viereck-Silberblatt, verchromter Rahmen — Square silver dial, chromium plated bezel  
Cadran carré argenté, lunette chromée — Esfera cuadrada plateada, bisel cromado

1 Tag Weckerwerk No. J 62 — 1 day alarm movement No. J 62  
30 heures réveil mouvement No. J 62 — 30 horas despertador máquina No. J 62



Durchmesser - Diameter - Diamètre  
Diámetro 5,5 cm = 2 1/8 inches

Kleine Kalotte, Werk J 36 mit 7 Steinen für Etui-Ausschnitt 53 mm  
 Große Kalotte, Werk J 36 mit 7 Steinen für Etui-Ausschnitt 63 1/2 mm  
 Small calotte, movement J 36 with 7 jewels for case-opening 53 mm  
 Large calotte, movement J 36 with 7 jewels for case-opening 63 1/2 mm  
 Petite calotte, mouvement J 36 à 7 rubis pour ouverture d'écrin de 53 mm  
 Grande calotte, mouvement J 36 à 7 rubis pour ouverture d'écrin de 63 1/2 mm  
 Máquina completa pequeña J 36 á 7 rubis para abertura de estuche de 53 mm  
 Máquina completa grande J 36 á 7 rubis para abertura de estuche de 63 1/2 mm



9 x 9 cm = 3 1/2 x 3 1/2 inches

101/37 RZ

Schwarz Saffian - Black morocco  
 Maroquin noir - Cabra negra



9 x 9 cm = 3 1/2 x 3 1/2 inches

101/40 RZ

Echt Saffian, cochenillerot - Cochineal morocco  
 Maroquin cochenille - Cabra cochenilla



9 x 9 cm = 3 1/2 x 3 1/2 inches

101/41 RZ

Braun Carara matt - Brown carara mat  
 Carara brun mat - Carara mate, moreno

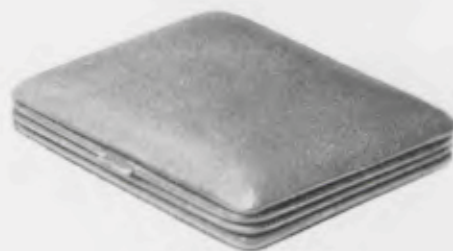

9 x 9 cm = 3 1/2 x 3 1/2 inches

101/66 RZ

Echt Saffian braun - Morocco brown  
 Maroquin brun - Cabra moreno

1 Tag Weckerwerk No. J 36 mit 7 Steinen - 1 day alarm movement No. J 36 with 7 jewels - 30 heures réveil mouvement No. J 36 avec 7 rubis - Despertador, 30 horas cuerda, máquina No. J 36 con 7 rubis



9 x 9 cm = 3 1/2 x 3 1/2 inches

101/59 RZ

Schattenrindleder hellbraun - Cowhide brown  
 Cuir de bœuf brun avec ombres  
 Cuero de buey moreno con sombras



9 x 9 cm = 3 1/2 x 3 1/2 inches

101/61 RZ

Schattenrindleder hellbraun - Cowhide brown  
 Cuir de bœuf brun avec ombres  
 Cuero de buey moreno con sombras



9 x 9 cm = 3 1/2 x 3 1/2 inches

101/63 RZ

Saffian, rotbraun - Morocco brown  
 Maroquin brun - Cabra moreno



11 x 9 cm = 4 1/4 x 3 1/2 inches

101/65 RZ

Echt Saffian, blau - Morocco blue  
 Maroquin bleu - Cabra azul

1 Tag Weckerwerk No. J 36 mit 7 Steinen - 1 day alarm movement No. J 36 with 7 jewels  
 30 heures réveil mouvement No. J 36 avec 7 rubis - Despertador, 30 horas cuerda, máquina  
 No. J 36 con 7 rubis



GRUPPE 4

Kleinste Qualitäts-Wecker – Ankerwerke mit Taschenuhrhemmung

Smallest highclass quality alarms – Lever-movement with watch escapement

Réveils miniature de qualité supérieure – Mouvement à ancre avec échappement de montre de poche

Despertadores miniatura de calidad superior – Máquina á áncora con escape de reloj de bolsillo

1 Tag Weckerwerk No. J 63 – 1 day alarm movement No. J 63

30 heures réveil mouvement No. J 63 – 30 horas despertador máquina No. J 63

Cœur



5,5 cm = 2 1/4 inches

- 4/69 RZ Vernickelt – Nickelled – Nickelé – Niquelado
- 4/144 RZ Bordorot – Claret coloured – Rouge Bordeaux – Esmalte color Burdeos
- 4/119 RZ Brillantschwarz – Brilliant black – Noir diamant – Esmalte negro



6 cm = 2 3/8 inches

Neu-Alemannia

- 4/282 RZ Bordorot – Claret coloured – Rouge Bordeaux – Esmalte color Burdeos
- 4/291 RZ Rotbraun – Claret coloured – Brun-rouge – Rojo oscuro
- 4/292 RZ Blau – Blue – Bleu – Azul
- 4/295 RZ Verchromt, Silberblatt – Chromium plated, silver dial – Chromé, cadran argenté – Cromado, esfera plateada

Bügel-Absteller – The alarm is stopped by pushing the handle down  
Arrêtage du réveil par la poignée – El despertador se para doblando la manija

Neu-Alemannia



6 cm = 2 3/8 inches

- 4/301 RZ Rotbraun – Claret coloured – Brun-rouge – Rojo oscuro
- 4/302 RZ Blau – Blue – Bleu – Azul
- 4/303 RZ Verchromt, Silberblatt – Chromium plated, silver dial – Chromé, cadran argenté – Cromado, esfera plateada

Bügel-Absteller – The alarm is stopped by pushing the handle down  
Arrêtage du réveil par la poignée – El despertador se para doblando la manija



6 cm = 2 3/8 inches

Neu-Alemannia

- 4/304 RZ Verchromt, Silberblatt – Chromium plated, silver dial – Chromé, cadran argenté – Cromado, esfera plateada

Bügel-Absteller – The alarm is stopped by pushing the handle down  
Arrêtage du réveil par la poignée – El despertador se para doblando la manija

Teutonia



6,5 cm = 2 1/2 inches

- 4/175 RZ Vernickelt – Nickelled – Nickelé – Niquelado
- 4/176 RZ Bordorot – Claret coloured – Rouge Bordeaux – Esmalte color Burdeos



6,5 cm = 2 1/2 inches

Teutonia

- 4/309 RZ Lederüberzug rot – Leather-covered case red – Boîte couverte de cuir rouge – Caja cubierta de cuero encarnado

- 4/310 RZ Lederüberzug braun – Leather-covered case brown – Boîte couverte de cuir brun – Caja cubierta de cuero moreno

Silber-, Gold- und Kartonblatt mit Radium-Ausstattung (RZ)  
Silvered, gilt and cardboard dial with luminous figures (RZ)  
Cadran argenté, doré et cadran carton avec chiffres lumineux Radium (RZ)  
Esfera plateada, dorada y esfera de cartón con cifras luminosas Radium (RZ)



1 Tag Weckerwerk No. J 63 – 1 day alarm movement No. J 63

30 heures réveil mouvement No. J 63 – 30 horas despertador máquina No. J 63

Suevia



7,5 cm = 3 inches

- 4/182 RZ Vernickelt – Nickelled – Nickelé – Niquelado
- 4/299 RZ Rotbraun – Claret coloured – Brun-rouge – Rojo oscuro
- 4/300 RZ Blau – Blue – Bleu – Azul

Frankonia



6,5 cm = 2 1/2 inches

- 4/170 RZ Vernickelt – Nickelled – Nickelé – Niquelado
- 4/305 RZ Rotbraun – Claret coloured – Brun-rouge – Rojo oscuro
- 4/306 RZ Blau – Blue – Bleu – Azul

Neu-Suevia



6,5 cm = 2 1/2 inches

- 4/284 RZ Verchromt, Silberblatt – Chromium plated, silver dial – Chromé, cadran argenté – Cromado, esfera plateada
- 4/285 RZ Bordorot – Claret coloured – Rouge Bordeaux – Color Burdeos
- 4/286 RZ Brillantschwarz – Brilliant black – Noir diamant – Negro brillante
- 4/311 RZ Verchromt, Silber-Strichblatt – Chromium plated, silver dial with strokes – Cadran argenté avec barres – Esfera plateada con rayas

Gold-, Silber- und Kartonblatt mit Radium-Ausstattung (RZ)  
Gilt, silvered and cardboard dial with luminous figures (RZ)  
Cadran doré, argenté et cadran carton avec chiffres lumineux Radium (RZ)  
Esfera plateada, dorada y esfera de cartón con cifras luminosas Radium (RZ)

Darling



10 cm = 4 inches

- 4/108 RZ Königsrot – Red enamelled – Pourpre de roi – Esmalte rojo
- 4/109 RZ Brillantschwarz – Brilliant black – Noir diamant – Esmalte negro

Saxonia



6 cm = 2 3/8 inches

- 4/180 RZ Vernickelt – Nickelled – Nickelé – Niquelado
- 4/307 RZ Rotbraun – Claret coloured – Brun-rouge – Rojo oscuro
- 4/308 RZ Blau – Blue – Bleu – Azul

Etui zu Neu-Suevia



6 x 6,5 cm = 2 3/8 x 2 1/2 inches

- 4/195 a Etui rot, Lederimitation – Red imitation leather case – Ecrin rouge, imitation cuir – Estuche de cuero imitación, rojo



1 Tag Weckerwerk No. J 63 - 1 day alarm movement No. J 63  
 30 heures réveil mouvement No. J 63 - 30 horas despertador, máquina No. J 63



8,5 x 10 cm - 3 1/4 x 4 inches

4/314 RZ

Nußbaummaser poliert mit verchromter Auflage  
 Polished bur walnut with chromium plated stripe  
 Loupe de noyer poli avec applique chromée  
 Raíz de nogal pulido con faja cromada



8 x 12 cm - 3 1/4 x 4 3/4 inches

4/313 RZ

Nußbaummaser poliert - Polished bur walnut  
 Loupe de noyer poli - Raíz de nogal pulido



8,5 x 12 cm - 3 1/4 x 4 3/4 inches

4/312 RZ

Schleiflack schwarz - Varnished black dull  
 Peinture noire laquée dépolie - Barniz pulido mate, negro

Chrom-Sockel - Chromium plated base - Socle chromé - Zócalo cromado

Chrom-Lünette, Silberblatt - Chromium plated bezel, silver dial - Lunette chromée, cadran argenté  
 Bisel cromado, esfera plateada



Schwingende Uhren, geschützte Junghans-Spezialität

8 Tag Gehwerk auf Steinen laufend

8 day Mystery Clocks, „Junghans“ speciality  
 swinging pendulum suspended on jewelled bar

Pendulettes Oscillantes dites Mystérieuses, spécialité brevetée - Junghans  
 Marche 8 jours sur bras empierré

Relojes oscilantes, 8 días cuerda, sobre rubis  
 Modelos especiales registrados por la fábrica Junghans

Kunstgußfiguren

Bronze figures - Sujets artistiques en imitation bronze - Figuras de fundición artística



Elefant

29 cm - 11 1/2 inches

4/51

Elegant

Salome

Gamin



35,5 cm - 14 inches  
 4/48 4/49



48 cm - 19 1/4 inches  
 4/101



45 cm - 17 3/4 inches  
 4/106

4/48 Patiniert, polierter Holzsockel - Patina, polished wooden base - Patiné, socle en bois poli - Imitación bronce viejo, zócalo de madera pulida  
 4/49 Vergoldet, polierter Holzsockel - Gilt, polished wooden base - Doré, socle en bois poli - Dorado, zócalo de madera pulida  
 4/51 Patiniert, polierter Holzsockel - Patina, polished wooden base - Patiné, socle en bois poli - Imitación bronce viejo, zócalo de madera pulida  
 4/101 Patiniert, polierter Holzsockel - Patina, polished wooden base - Patiné, socle en bois poli - Imitación bronce viejo, zócalo de madera pulida  
 4/106 Patiniert - Patina - Patiné - Imitación bronce viejo

Vorzügliche Regulierung / Absolute Unempfindlichkeit im Gebrauch, weil ohne Pendelfeder - Excellent time keeper / The clock, having no pendulum spring, is absolutely insensible in handling - Réglage excellent / Insensibilité absolue dans l'emploi, parce que sans lame de suspension  
 Afinación exacta y por falta del muelle de suspensión inalterable en el uso





GRUPPE 5

Feine Boudoir-Uhren mit Qualitätswerk

Highclass quality boudoir clocks - Pendulettes de boudoir, qualité supérieure  
Relojes para tocador de calidad superior



8 x 8 cm = 3 1/4 x 3 1/4 inches

5/178 1 Tag Weckerwerk No. J 62 - 1 day alarm No. J 62 5/184  
30 heures réveil No. J 62 - Despertador, 30 horas cuerda No. J 62

5/179 8 Tag Ankergehwerk No. J 44 - 8 day lever time movement No. J 44 5/185  
Mouvement 8 jours simple, échappement à ancre No. J 44  
Máquina 8 días cuerda, escape á âncora No. J 44

Verchromt poliert, Silberblatt - Chromium plated, polished, silver dial  
Chromé, poli, cadran argenté - Cromado, pulido, esfera plateada



10 x 10 cm = 4 x 4 inches



10 x 10 cm = 4 x 4 inches

5/195 1 Tag Weckerwerk No. J 62 - 1 day alarm No. J 62  
30 heures réveil No. J 62 - Despertador, 30 horas cuerda No. J 62

5/196 8 Tag Ankergehwerk No. J 44 - 8 day lever time movement No. J 44 - Mouvement 8 jours simple, échappement à ancre No. J 44 - Máquina 8 días cuerda, escape á âncora No. J 44

Verchromt poliert, Silberblatt mit blauen Zahlen  
Chromium plated, polished, silver dial with blue figures  
Chromé poli, cadran argenté avec chiffres bleus  
Cromado pulido, esfera plateada con cifras azules



10 x 10 cm = 4 x 4 inches

5/197 8 Tag Ankergehwerk No. J 44 - 8 day lever time movement No. J 44 - 8 jours simple, échappement à ancre No. J 44 - Máquina 8 días cuerda, escape á âncora No. J 44

Verchromt poliert, Silberblatt, weiß polierte Striche  
Chromium plated polished, silver dial, polished white strokes

Chromé poli, cadran argenté, barres blanches polies  
Cromado pulido, esfera plateada, rayas blancas pulidas



13 x 13 cm = 5 1/2 x 5 1/4 inches

5/190 Verchromt poliert, Silberblatt - Chromium plated, polished, silver dial - Chromé, poli, cadran argenté - Cromado, pulido, esfera plateada



14 x 14 cm = 5 1/2 x 5 1/4 inches

5/198 Verchromt poliert, Silberblatt mit blauen Zahlen  
Chromium plated, polished, silver dial with blue figures - Chromé, poli, cadran argenté avec chiffres bleus - Cromado pulido, esfera plateada con cifras azules

8 Tag Ankergehwerk No. J 44 - 8 day lever time movement No. J 44

Mouvement 8 jours simple, échappement à ancre No. J 44 - Máquina 8 días cuerda, escape á âncora No. J 44



14 x 14 cm = 5 1/2 x 5 1/4 inches

Verchromt poliert - Chromium plated, polished  
Chromé, poli - Cromado pulido

5/200 Silberblatt, blau polierte Striche - Silver dial, polished blue strokes - Cadran argenté, barres bleues polies - Esfera plateada, rayas azules pulidas

5/201 Silberblatt, weiß polierte Striche - Silver dial, polished white strokes - Cadran argenté, barres blanches polies - Esfera plateada, rayas blancas pulidas

8 Tag Ankergehwerk No. J 44 - 8 day lever time movement No. J 44

8 jours simple, échappement à ancre No. J 44 - Máquina 8 días cuerda, escape á âncora No. J 44



14 x 14 cm = 5 1/2 x 5 1/4 inches

5/202 Mit Thermometer - With thermometer - Avec thermomètre - Con termómetro

Verchromt poliert, Silberblatt - Chromium plated, polished, silver dial - Chromé, poli, cadran argenté - Cromado, pulido, esfera plateada

Mit Celsius und Fahrenheit lieferbar - Can be had with Celsius and Fahrenheit - Livrable en Celsius et Fahrenheit - Se hace en Celsius y Fahrenheit



7,5 x 11 cm = 3 x 4 1/4 inches

5/193 1 Tag Weckerwerk No. J 62 - 1 day alarm No. J 62  
30 heures réveil No. J 62 - Despertador, 30 horas  
cuerda No. J 62

5/199 8 Tag Ankergehwerk No. J 44 - 8 day lever time  
movement No. J 44 - Mouvement 8 jours simple,  
échappement à ancre No. J 44 - Máquina 8 días  
cuerda, escape á áncora No. J 44

Verchromt poliert, Silberblatt - Chromium plated, polished, silver dial - Chromé, poli, cadran argenté  
Cromado, pulido, esfera plateada

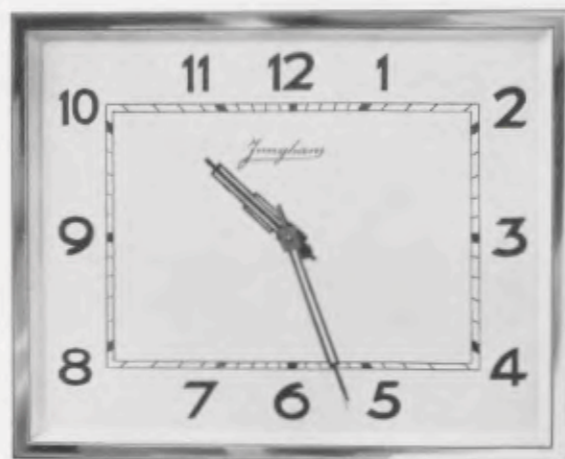

12,5 x 15,5 cm = 4 7/8 x 6 inches

5/194 8 Tag Ankergehwerk No. J 44 - 8 day lever time  
movement No. J 44 - Mouvement 8 jours simple,  
échappement à ancre No. J 44 - Máquina, 8 días  
cuerda, escape á áncora No. J 44



9,5 x 12,5 cm = 3 3/4 x 5 inches

5/180 1 Tag Weckerwerk No. J 62 - 1 day alarm No. J 62 - 30 heures  
réveil No. J 62 - Despertador, 30 horas cuerda No. J 62

5/181 8 Tag Ankergehwerk No. J 44 - 8 day lever time movement No. J 44  
Mouvement 8 jours simple, échappement à ancre No. J 44 - Máquina  
8 días cuerda, escape á áncora No. J 44

Verchromt poliert, Silberblatt - Chromium plated, polished, silver dial - Chromé, poli, cadran argenté  
Cromado, pulido, esfera plateada



11,5 x 15 cm = 4 1/2 x 6 inches

5/188

5/189



9,5 x 8,5 cm = 3 3/4 x 3 1/4 inches

5/203 Verchromt, poliert und matt, Silberblatt  
Chromium plated, polished and mat, silver dial - Chromé, poli et mat, cadran  
argenté - Cromado, pulido y mate, esfera  
plateada

1 Tag Weckerwerk No. J 62 - 1 day alarm movement No. J 62 - 30 heures réveil No. J 62  
Despertador, 30 horas cuerda No. J 62



8,5 x 17 cm = 3 1/4 x 6 3/4 inches

5/204 Verchromt poliert, Silberblatt - Chromium  
plated, polished, silver dial - Chromé,  
poli, cadran argenté - Cromado, pulido,  
esfera plateada



23,5 x 9 cm = 9 1/4 x 3 1/2 inches

5/205 1 Tag Wecker No. J 62 - 1 day alarm movement No. J 62 - 30 heures réveil No. J 62  
Despertador, 30 horas cuerda No. J 62

5/206 8 Tag Ankergehwerk No. J 44 - 8 day lever time movement No. J 44 - Mouvement 8 jours  
simple, échappement à ancre No. J 44 - Máquina 8 días cuerda, escape á áncora No. J 44

Verchromt poliert, Silberblatt mit weiß polierten Zahlen - Chromium plated, polished, silver dial with white polished figures  
Chromé, poli, cadran argenté avec chiffres blancs, polis - Cromado pulido, esfera plateada con cifras blancas, pulidas



18 x 9,5 cm = 7 1/4 x 3 3/4 inches

5/207 1 Tag Weckerwerk No. J 62 - 1 day alarm movement No. J 62 - 30 heures réveil No. J 62  
Despertador, 30 horas cuerda No. J 62

5/208 8 Tag Ankergehwerk No. J 44 - 8 day lever time movement No. J 44 - Mouvement 8 jours  
simple, échappement à ancre No. J 44 - Máquina 8 días cuerda, escape á áncora No. J 44

Verchromt, poliert und matt, Silberblatt mit weiß polierten Zahlen - Chromium plated, polished and mat, silver dial  
with white polished figures - Chromé, poli et mat, cadran argenté avec chiffres blancs, polis  
Cromado, pulido y mate, esfera plateada con cifras blancas, pulidas



17 x 15,5 cm = 6 7/8 x 6 1/8 inches

5/209 Verchromt poliert, Silberblatt mit weiß polierten Zahlen  
Chromium plated, polished, silver dial with white polished figures  
Chromé, poli, cadran argenté avec chiffres blancs, polis  
Cromado, pulido, esfera plateada con cifras blancas, pulidas



20 x 15,5 cm = 7 7/8 x 6 1/8 inches

5/210 Verchromt mit kaukasisch Nußbaum poliert, Silberblatt  
Chromium plated with polished Caucasian walnut, silver dial  
Chromé avec noyer Caucasiens poli, cadran argenté  
Cromado con nogal Cáucaso pulido, esfera plateada

8 Tag Ankergehwerk No. J 44 - 8 day lever time movement No. J 44  
Mouvement 8 jours simple, échappement à ancre No. J 44 - Máquina, 8 días cuerda, escape á áncora No. J 44



GRUPPE 6

*Boudoir-Uhren mit einfachem Ankerwerk*  
Boudoir clocks - Pendulettes de boudoir - Relojes para tocador



10 x 10 cm = 4 x 4 inches

6/11 1 Tag Gehwerk - 1 day time  
30 heures simple - 30 horas cuerda  
6/12 1 Tag Wecker - 1 day alarm  
30 heures réveil - 30 horas despertador



13 x 13 cm = 5 1/8 x 5 1/8 inches

6/3 1 Tag Gehwerk - 1 day time  
30 heures simple - 30 horas cuerda  
6/4 1 Tag Wecker - 1 day alarm  
30 heures réveil - 30 horas despertador



12,5 x 15,5 cm = 4 7/8 x 6 inches

6/5 1 Tag Gehwerk - 1 day time  
30 heures simple - 30 horas cuerda  
6/6 1 Tag Wecker - 1 day alarm  
30 heures réveil - 30 horas despertador

Chrom-Rahmen, Silberblatt - Chromium plated frame, silver dial  
Cadre chromé, cadran argenté - Marquito cromado, esfera plateada



11,5 x 15 cm = 4 1/2 x 6 inches

- 6/13 1 Tag Gehwerk - 1 day time - 30 heures simple - 30 horas cuerda  
 6/14 1 Tag Wecker - 1 day alarm - 30 heures réveil - 30 horas despertador

Verchromt, Silberblatt - Chromium plated, silver dial - Chromé, cadran argenté - Cromado, esfera plateada

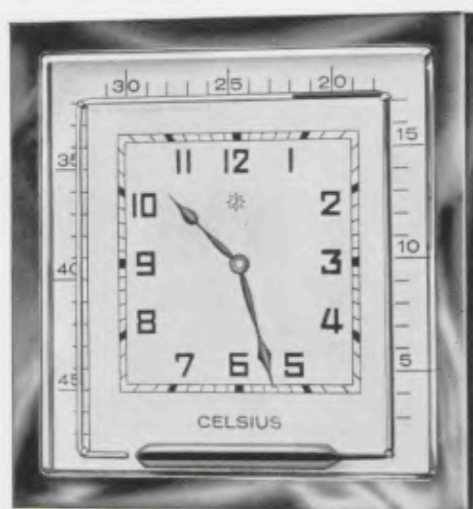

13 x 13 cm = 5 1/4 x 5 1/4 inches

- 6/15 1 Tag Gehwerk - 1 day time - 30 heures simple - 30 horas cuerda  
 6/16 1 Tag Wecker - 1 day alarm - 30 heures réveil - 30 horas despertador

Mit Celsius und Fahrenheit lieferbar - Can be had with Celsius and Fahrenheit  
 Livrable en Celsius et Fahrenheit - Se hace en Celsius y Fahrenheit

Chrom-Rahmen, Silberblatt mit Thermometer - Chromium plated frame, silver dial with thermometer  
 Cadre chromé, cadran argenté avec thermomètre - Marquito cromado, esfera plateada con termómetro



GRUPPE 54

Miniatur-Wecker mit Hohltriebwerk ohne Federhaus

Miniature-Alarms, movement with lantern pinions, without spring barrel - Réveils miniature, mouvement avec pignons lanternes, sans barillet - Despertadores miniatura, máquina con piñones de linterna, sin barrilete

Primus I



8,5 cm = 3 1/4 inches

- 54/1 1 Tag Gehwerk - 1 day time - 30 heures simple - 30 horas cuerda

Zinkgehäuse vernickelt, weiß Kartonblatt - Zinc case nickelled, white cardboard dial - Boîte zinc nickelé, cadran carton blanc - Caja de zinc niquelado, esfera blanca de cartón

Primus II



10,5 cm = 4 1/4 inches

- 54/3 1 Tag Wecker - 1 day alarm - 30 heures réveil - 30 horas despertador

Zinkgehäuse vernickelt, weiß Kartonblatt - Zinc case nickelled, white cardboard dial - Boîte zinc nickelé, cadran carton blanc - Caja de zinc niquelado, esfera blanca de cartón

Desk I



10 cm = 4 inches

- 54/12 1 Tag Gehwerk - 1 day time - 30 heures simple - 30 horas cuerda

Messinggehäuse vernickelt, Zelluloidblatt - Brass case nickelled, celluloid dial - Boîte laiton nickelé, cadran celluloid - Caja de latón niquelado, esfera de celuloide

Desk II



12 cm = 4 3/4 inches

- 54/13 1 Tag Wecker - 1 day alarm - 30 heures réveil - 30 horas despertador

Messinggehäuse vernickelt, Silberblatt - Brass case nickelled, silver dial - Boîte laiton nickelé, cadran argenté - Caja de latón niquelado, esfera plateada

Kalender

14 cm = 5 1/2 inches



- 54/11 Metallgehäuse vernickelt, Silberblatt - Metal case nickelled, silver dial - Boîte métal nickelé, cadran argenté - Caja de metal niquelado, esfera plateada

- 54/161 Metallgehäuse rotbraun, Weißblatt - Claret coloured metal case, white cardboard dial - Boîte métal brun-rouge, cadran carton blanc - Caja de metal rojo oscuro, esfera blanca de cartón

- 54/162 Metallgehäuse grün, Weißblatt - Green metal case, white cardboard dial - Boîte métal vert, cadran carton blanc - Caja de metal verde, esfera blanca de cartón

- 54/163 Metallgehäuse blau, Weißblatt - Blue metal case, white cardboard dial - Boîte métal bleu, cadran carton blanc - Caja de metal azul, esfera blanca de cartón

- 1 Tag Gehwerk - 1 day time - 30 heures simple - 30 horas cuerda



Applaus



10 cm = 4 inches

- 54/91 Metallgehäuse rotbraun - Claret coloured metal case - Boîte métal brun-rouge - Caja de metal rojo oscuro
- 54/97 Metallgehäuse blau - Blue metal case - Boîte métal bleu - Caja de metal azul
- 1 Tag Wecker - 1 day alarm  
30 heures réveil - Despertador, 30 horas cuerda

Azur



8 x 8 cm = 3 1/8 x 3 1/8 inches

- 54/120 1 Tag Gehwerk - 1 day time - 30 heures simple - 30 horas cuerda
- 54/121 1 Tag Wecker - 1 day alarm  
30 heures réveil - 30 horas despertador
- Verchromtes Metallgehäuse mit blau lackiertem Band - Chromium plated metal case with blue band - Boîte métal chromé avec ruban bleu - Caja de metal cromado y azul

Gloria



8 x 6 cm = 3 x 2 1/4 inches

- 54/104 Metallgehäuse verchromt, Silberblatt - Chromium plated metal case, silver dial - Boîte métal chromé, cadran argenté - Caja de metal cromado, esfera plateada
- 54/105 Metallgehäuse rotbraun - Claret coloured metal case - Boîte métal brun-rouge - Caja de metal rojo oscuro
- 54/106 Metallgehäuse grün - Green metal case - Boîte métal verte - Caja de metal verde
- 54/107 Metallgehäuse blau - Blue metal case - Boîte métal bleue - Caja de metal azul
- Karton-Goldblatt - Gilt cardboard dial - Cadran carton doré - Esfera dorada de cartón
- Bügelabsteller - The alarm is stopped by pushing the handle down - Arrêtage du réveil par la poignée - El despertador se para doblando la manija

1 Tag Wecker - 1 day alarm  
30 heures réveil - Despertador, 30 horas cuerda

Start



8 cm = 3 1/8 inches

- 54/100 Metallgehäuse meergrün - Metal case jade green - Boîte métal vert de mer - Caja de metal color esmalte verde
- 54/101 Metallgehäuse hellrot - Metal case light red - Boîte métal rouge clair - Caja de metal rojo claro
- 54/102 Metallgehäuse blau - Blue metal case - Boîte métal bleu - Caja de metal azul
- 54/119 Metallgehäuse verchromt, Silberblatt - Chromium plated metal case, silver dial - Boîte métal chromé, cadran argenté - Caja de metal cromado, esfera plateada
- Bügelabsteller - The alarm is stopped by pushing the handle down - Arrêtage du réveil par la poignée - El despertador se para doblando la manija



7,5 x 12,5 cm = 3 x 5 inches

54/243 Eiche - Oak - Chêne - Roble

Goldbronziertes Kartonblatt - Goldbronze cardboard dial - Cadran carton bronze doré - Esfera de cartón bronce dorada



8,5 x 12 cm = 3 3/8 x 4 3/8 inches

54/244 Eiche - Oak - Chêne - Roble

Chrom-Lünette, weißes Kartonblatt - Chromium plated bezel, white cardboard dial - Lunette chromée, cadran carton blanc - Bisel cromado, esfera blanca de cartón



8,5 x 13 cm = 3 3/8 x 5 1/8 inches

54/245 Eiche - Oak - Chêne - Roble

Chrom-Lünette, weißes Kartonblatt - Chromium plated bezel, white cardboard dial - Lunette chromée, cadran carton blanc - Bisel cromado, esfera blanca de cartón



8,5 x 12 cm = 3 3/8 x 4 3/8 inches

54/246 Nußbaum poliert - Polished walnut

Noyer poli - Nogal pulido

54/247 Mahagoni - Mahogany - Acajou - Caoba

Goldbronzierte Lünette und Kartonblatt - Gold bronze bezel and cardboard dial - Lunette et cadran carton bronce doré - Bisel y esfera de cartón bronce dorada

1 Tag Weckerwerk ohne Federhäuser - 1 day alarm movement without spring barrels - Mouvement 30 heures réveil sans barillets - Despertador 30 horas cuerda, sin barriletes

Mit oder ohne Radium-Ausstattung (RZ) - With or without luminous figures (RZ) - Avec ou sans chiffres lumineux Radium (RZ) - Con ó sin cifras luminosas Radium (RZ)



GRUPPE 7

Miniatur-Wecker, Hohltriebwerk mit Federhaus

Miniature-Alarms, movement with lantern pinions and spring barrels - Réveils miniature, mouvement avec pignons lanternes et barillet - Despertadores miniatura, máquina con piñones de linterna y con barrilete

Pico



10 cm = 4 inches

7/171 Messinggehäuse vernickelt - Brass case nickelled - Boîte laiton nickelé - Caja de latón niquelado  
Zelluloidblatt - Celluloid dial - Cadran celluloid - Esfera de celuloide

Delight



9 cm = 3 1/2 inches

7/160 Bordorot - Claret coloured - Rouge Bordeaux - Esmalte color Burdeos  
Emailblatt - Enamel dial - Cadran émail - Esfera de esmalte

Neu-Triumph



7 x 6 cm = 2 3/4 x 2 1/2 inches

Messinggehäuse - Brass case - Boîte laiton - Caja de latón  
7/195 Vernickelt - Nickelled - Nickelé - Niquelado  
Silberblatt - Silver dial - Cadran argenté - Esfera plateada  
7/196 Bordorot - Claret coloured - Rouge Bordeaux - Color Burdeos  
Goldblatt - Gilt dial - Cadran doré - Esfera dorado

Splendid



8 cm = 3 1/4 inches

7/172 Königsrot - Red enamelled - Pourpre de roi - Esmalte rojo  
Emailblatt - Enamel dial - Cadran émail - Esfera de esmalte



9 x 12 cm = 3 1/2 x 4 3/4 inches

7/321 Kaukasisch Nußbaum poliert - Polished Caucasian walnut - Noyer Caucasicn poli - Nogal Cáucaso pulido



9 x 13 cm = 3 1/2 x 5 1/8 inches

7/322 Nußbaum poliert - Polished walnut - Noyer poli - Nogal pulido

Chrom-Lünette, Silberblatt - Chromium plated bezel, silver dial - Lunette chromée, cadran argenté - Bisel cromado, esfera plateada

1 Tag Wecker - 1 day alarm - 30 heures réveil - Despertador, 30 horas cuerda



GRUPPEN 8 und 56

Wecker in Metallgehäusen

Alarm clocks in metal cases - Réveils en boîtes métal - Despertadores en cajas de metal

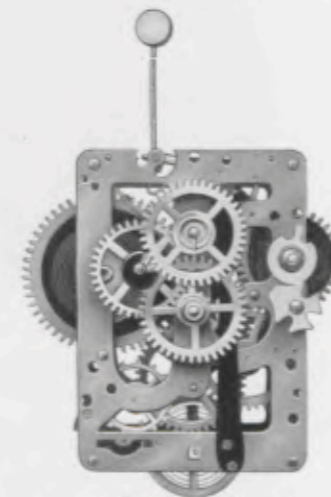

8,2 x 5,8 cm = 3 1/4 x 2 1/4 inches

No. 10 Großes Werk  
Large movement  
Grand mouvement  
Máquina grande

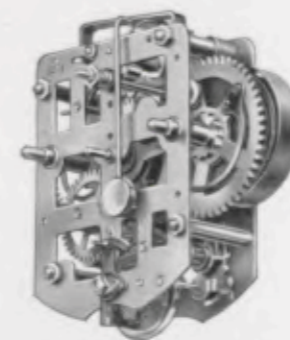

7,1 x 5,6 cm = 2 3/4 x 2 1/8 inches

No. 231 Kleines Werk, große Balance  
Small movement, large balance  
Petit mouvement, grand balancier  
Máquina pequeña, volante grande

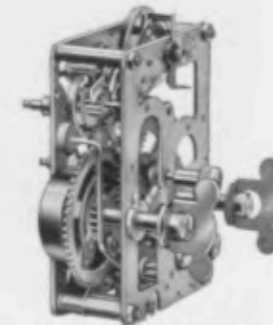

8,2 x 5,8 cm = 3 1/4 x 2 1/4 inches

No. 10 G Großes Werk, lautlos  
Large movement, silent  
Grand mouvement, silencieux  
Máquina grande, silenciosa

Junghans-Baby



19 cm = 7½ inches

- 8/2 Metallgehäuse vernickelt - Metal case nickelled  
Boîte métal nickelé - Caja de metal niquelado
  - 8/2 M Messinggehäuse vernickelt - Brass case nickelled  
Boîte laiton nickelé - Caja de latón niquelado
  - 8/45 Messinggehäuse verkupfert - Brass case coppered  
Boîte laiton cuivré - Caja de latón cobreado
- Weißes Kartonblatt - White cardboard dial  
Cadran carton blanc - Esfera blanca de cartón
- Großes Werk, staubdichte Messing- oder Zelluloidrückwand - Large movement, dustproof brass or celluloid back - Grand mouvement, fond laiton ou fond celluloid hermétique - Máquina grande, respaldo hermético de latón ó celuloide

Baby



18 cm = 7 inches

- 8/242 Metallgehäuse vernickelt - Metal case nickelled  
Boîte métal nickelé - Caja de metal niquelado
  - 8/242 M Messinggehäuse vernickelt - Brass case nickelled  
Boîte laiton nickelé - Caja de latón niquelado
- Großes Werk, staubdichter Regulierschlit - Large movement, dustproof regulating-slot  
Grand mouvement, fente de réglage hermétique - Máquina grande, hendrija de ajustamiento hermética

Stella



18 cm = 7 inches

- 8/100 Metallgehäuse vernickelt - Metal case nickelled  
Boîte métal nickelé - Caja de metal niquelado
  - 8/100 M Messinggehäuse vernickelt - Brass case nickelled  
Boîte laiton nickelé - Caja de latón niquelado
- Staubdichter Regulierschlit - Dustproof regulating-slot - Fente de réglage hermétique - Hendrija de ajustamiento hermética

Baby



18 cm = 7 inches

- 8/99 Metallgehäuse vernickelt - Metal case nickelled  
Boîte métal nickelé - Caja de metal niquelado
- 8/234 Rotbraun - Claret coloured - Brun-rouge  
Rojo oscuro
- 8/235 Blau - Blue - Bleu - Azul
- 8/236 Grün - Green - Vert - Verde

Kleines Werk - Small movement - Petit mouvement - Máquina pequeña



Globe



14 cm = 5½ inches

- 8/190 Gehwerk - Time movement  
Mouvement simple - Movimiento solo
- Metallgehäuse vernickelt - Metal case nickelled  
Boîte métal nickelé - Caja de metal niquelado

Globe



16 cm = 6¼ inches

- 8/191 Metallgehäuse vernickelt - Metal case nickelled  
Boîte métal nickelé - Caja de metal niquelado
- 1 Tag Wecker, kleines Werk - 1 day alarm, small movement - 30 heures réveil, petit mouvement - 30 horas despertador, máquina pequeña

Globe



13,5 cm = 5¼ inches

- 8/276 Rothbraun - Claret coloured  
Brun-rouge - Rojo oscuro
  - 8/277 Blau - Blue - Bleu - Azul
  - 8/278 Grün - Green - Vert - Verde
  - 8/309 Vernickelt - Nickelled - Nickelé - Niquelado
- Schlag auf Rückwand - Strike on back  
Sonnerie sur fond - Tocando en el respaldo

Tommy



18 cm = 7 inches

- 8/228 Metallgehäuse vernickelt - Metal case nickelled  
Boîte métal nickelé - Caja de metal niquelado

1 Tag Wecker, kleines Werk - 1 day alarm, small movement - 30 heures réveil, petit mouvement  
30 horas despertador, máquina pequeña



Bravo



14,5 cm = 5 3/4 inches

- 8/197 Vernickelt - Nickelled - Nickelé - Niquelado
- 8/198 Blau - Blue - Bleu - Azul
- 8/199 Grün - Green - Vert - Verde
- 8/200 Rotbraun - Claret coloured - Brun-rouge  
Rojo oscuro
- 8/233 Verchromt - Chromium plated - Chromé  
Cromado
- 1 Tag Wecker, Schlag auf Rückwand - 1 day  
alarm, strike on back - 30 heures réveil, sonnerie  
sur fond - 30 horas despertador, tocando  
en el respaldo
- 8/201 Mit Repetition - Repeating alarm - Avec  
répétition - Con repetición
- Rotbraun - Claret coloured - Brun-rouge  
Rojo oscuro

Kleines Werk - Small movement - Petit mouvement - Máquina pequeña

Bravetto



12 cm = 4 3/4 inches

- 8/209 Blau - Blue - Bleu - Azul
- 8/210 Grün - Green - Vert - Verde
- 8/211 Rotbraun - Claret coloured - Brun-rouge  
Rojo oscuro
- 8/184 Verchromt - Chromium plated - Chromé  
Cromado
- Weißes Kartonblatt - White cardboard dial  
Cadran carton blanc - Esfera blanca de cartón
- 8/184: Auch mit Silberblatt lieferbar - Can also be had  
with silver dial - Se livre aussi avec cadran  
argenté - Se hace también con esfera plateada
- 1 Tag Wecker, Schlag auf Rückwand  
1 day alarm, strike on back  
30 heures réveil, sonnerie sur fond  
30 horas despertador, tocando en el respaldo

Bravo auf Sockel



14x12 cm = 5 1/2 x 4 3/4 inches

- ReiBlack - Crackle colour - Verni craquelé - Barniz  
rompiente marron
- 8/202 Blau mit schwarz - Blue with black - Bleu et  
noir - Azul y negro
- 8/203 Rot mit schwarz - Red with black - Rouge et  
noir - Rojo y negro
- 8/204 Hellbraun mit Gold - Brown with gold - Brun  
clair et doré - Moreno claro y oro
- 1 Tag Wecker, Schlag auf Rückwand - 1 day alarm,  
strike on back - 30 heures réveil, sonnerie sur  
fond - 30 horas despertador, tocando en el respaldo
- 8/205 Mit Repetition - Repeating alarm - Avec  
répétition - Con repetición
- Hellbraun mit Gold - Brown with gold - Brun  
clair et doré - Moreno claro y oro

Bravo J



14 cm = 5 1/2 inches

- 8/220 Metallgehäuse grün - Metal case green  
Boîte métal vert - Caja de metal verde
- 8/221 Metallgehäuse blau - Metal case blue  
Boîte métal bleu - Caja de metal azul
- 8/222 Metallgehäuse rotbraun - Metal case claret  
coloured - Boîte métal brun-rouge - Caja  
de metal rojo oscuro
- 1 Tag Wecker, großes Werk - 1 day alarm,  
large movement - 30 heures réveil, grand  
mouvement - 30 horas despertador, má-  
quina grande



Boxer



12 cm = 4 3/4 inches

- 8/213 Vernickelt - Nickelled - Nickelé - Niquelado
- 8/214 Grün - Green - Vert - Verde
- 8/215 Blau - Blue - Bleu - Azul
- 8/216 Rotbraun - Claret coloured - Brun-rouge  
Rojo oscuro
- Mit Repetition - Repeating alarm - Avec  
répétition - Con repetición
- 8/307 Vernickelt - Nickelled - Nickelé - Niquelado
- 8/308 Rotbraun - Claret coloured - Brun-rouge  
Rojo oscuro

1 Tag Wecker, kleines Werk, Rückwandglocke - 1 day alarm, small movement, back bell  
30 heures réveil, petit mouvement, timbre fond - 30 horas despertador, máquina pequeña, campana en el respaldo

Pionier II



15,5 cm = 6 inches

- 8/208 Metallgehäuse vernickelt - Metal case nickel-  
led - Boîte métal nickelé - Caja de metal  
niquelado
- 1 Tag Wecker, kleines Werk, Rückwand-  
glocke, abstellbare Repetition - 1 day alarm,  
small movement, back bell, with both con-  
tinuous and repeating alarm at option - 30 heu-  
res réveil, petit mouvement, timbre fond,  
répétition à volonté - 30 horas despertador,  
máquina pequeña, campana en el respaldo,  
repetición á voluntad

Pionier I



14,5 cm = 5 3/4 inches

- 8/206 Rotbraun - Claret coloured - Brun-rouge  
Rojo oscuro
- 8/207 Vernickelt - Nickelled - Nickelé - Niquelado

Halli I



14 cm = 5 1/2 inches

- 8/223 Messinggehäuse vernickelt - Brass case nickel-  
led - Boîte laiton nickelé - Caja de latón  
niquelado
- 8/224 Messinggehäuse bordorot - Brass case claret  
coloured - Boîte laiton rouge Bordeaux - Caja  
de latón, esmalte color Burdeos
- 1 Tag Wecker, großes Werk, Rückwandglocke  
1 day alarm, large movement, back bell  
30 heures réveil, grand mouvement, timbre  
fond - 30 horas despertador, máquina grande,  
campana en el respaldo





Halli II



15 cm = 6 inches

8/225 Messinggehäuse vernickelt - Brass case nickelled  
Boîte laiton nickelé - Caja de latón niquelado

8/226 Messinggehäuse bordorot - Brass case claret coloured - Boîte laiton rouge Bordeaux - Caja de latón, esmalte color Burdeos

1 Tag Wecker, großes Werk, Rückwandglocke, abstellbare Repetition - 1 day alarm, large movement, back bell, with both continuous and repeating alarm at option - 30 heures réveil, grand mouvement, timbre fond, répétition à volonté - 30 horas despertador, máquina grande, campana en el respaldo, repetición á voluntad

Lloyd II



17 cm = 6 3/4 inches

8/227 Metallgehäuse vernickelt - Metal case nickelled  
Boîte métal nickelé - Caja de metal niquelado

1 Tag Wecker, großes Werk, Rückwandglocke, abstellbare Repetition - 1 day alarm, large movement, back bell, with both continuous and repeating alarm at option - 30 heures réveil, grand mouvement, timbre fond, répétition à volonté - 30 horas despertador, máquina grande, campana en el respaldo, repetición á voluntad

Regent I



12,5 cm = 5 inches

8/217 Blau - Blue - Bleu - Azul

8/218 Rotbraun - Claret coloured - Brun-rouge  
Rojo oscuro

8/219 Verchromt - Chromium plated - Chromé  
Cromado

Weißes Kartonblatt - White cardboard dial - Cadran carton blanc - Esfera blanca de cartón

8/219, 8/295: Auch mit Silberblatt lieferbar - Can also be had with silver dial - Se livre aussi avec cadran argenté  
Se hace tambien con esfera plateada

Kleines Werk - Small movement - Petit mouvement - Máquina pequeña

Regent II



11 cm = 4 1/4 inches

8/293 Blau - Blue - Bleu - Azul

8/294 Rotbraun - Claret coloured - Brun-rouge  
Rojo oscuro

8/295 Verchromt - Chromium plated - Chromé  
Cromado



Neu-Bravetto



10,5 cm = 4 1/8 inches

Metallgehäuse rotbraun - Claret coloured metal case - Boîte métal brun-rouge - Caja de metal rojo oscuro

8/266 Zahlen - Figures - Chiffres - Cifras

8/267 Striche - Strokes - Barres - Rayas

1 Tag Wecker - 1 day alarm  
30 heures réveil - 30 horas despertador

Neu-Bravetto



10,5 cm = 4 1/8 inches

Metallgehäuse verchromt mit blau emailliertem Band - Chromium plated metal case with blue enamelled centre-band - Boîte métal chromé avec bande émaillée bleue - Caja de metal cromada con cinta esmaltada azul

8/284 Zahlen - Figures - Chiffres - Cifras

8/285 Striche - Strokes - Barres - Rayas

Silberblatt - Silver dial - Cadran argenté  
Esfera plateada

1 Tag Wecker - 1 day alarm  
30 heures réveil - 30 horas despertador

Neu-Bravo



12,5 cm = 4 7/8 inches

Metallgehäuse rotbraun - Claret coloured metal case - Boîte métal brun-rouge - Caja de metal rojo oscuro

8/270 Zahlen - Figures - Chiffres - Cifras

8/271 Striche - Strokes - Barres - Rayas

1 Tag Wecker, Schlag auf Glocke - 1 day alarm, strike on bell - 30 heures réveil, sonnerie sur cloche - 30 horas despertador, campana en el fondo

Neu-Bravo



12,5 cm = 4 7/8 inches

Metallgehäuse verchromt - Chromium plated metal case - Boîte métal chromé - Caja de metal cromado

8/272 Zahlen - Figures - Chiffres - Cifras

8/273 Striche - Strokes - Barres - Rayas

Silber- oder Kartonblatt - Silver or cardboard dial - Cadran argenté ou de carton - Esfera plateada ó de cartón

1 Tag Wecker, Schlag auf Glocke - 1 day alarm, strike on bell - 30 heures réveil, sonnerie sur cloche - 30 horas despertador, campana en el fondo

Kleines Werk - Small movement - Petit mouvement - Máquina pequeña



Junghans „Silent“, der lautlos gehende Wecker

Junghans „Silent“

Junghans „Silent“



12,5 cm = 4 7/8 inches



12,5 cm = 4 7/8 inches

**8/301 Metallgehäuse rotbraun** – Claret coloured metal case – Boîte métal brun-rouge – Caja de metal rojo oscuro

**Weißes Kartonblatt** – White cardboard dial – Cadran carton blanc – Esfera blanca de cartón

**8/302 Metallgehäuse verchromt mit blau emailliertem Band** – Chromium plated metal case with blue enameled centre-band – Boîte métal chromé avec bande émaillée bleue – Caja de metal cromada con cinta esmaltada azul

**Silberblatt** – Silver dial – Cadran argenté – Esfera plateada

**1 Tag Weckerwerk No. 10 G, Schlag auf Glocke innen** – 1 day alarm movement No. 10 G, back bell 30 heures réveil mouvement No. 10 G, timbre fond – Despertador, 30 horas cuerda No. 10 G, campana en el respaldo

**Solange Wecker gebraucht werden,**

solange wird auch ihr Ticken störend empfunden. Mit seinem harten Rhythmus zerreit es die Stille der Nacht und raubt vielen Menschen den heißersehten, kräftigen Schlaf.

Schon lange wird daher an dem Problem des lautlos gehenden Weckers gearbeitet, doch ohne den rechten Erfolg, bis es endlich Junghans gelang, diese restlos befriedigende Konstruktion des lautlos tickenden Weckers zu schaffen.

Schon in einer Entfernung von 10 cm vom Ohr des Schlafers kann der Gang des Junghans „Silent“ auch in der Stille der Nacht nicht mehr gehört werden.

Junghans „Silent“, dieser sympathische Wecker, wird allen Menschen willkommen sein, die das Ticken bisher häufig am Einschlafen hinderte.

Wie ein stummer Diener wird er auch Ihren Schlaf bewachen und zur gewünschten Zeit, pünktlicher als der pünktlichste Diener, mit seinem hellen Weckruf beenden.

**Aussi longtemps que le réveil restera un objet indispensable,**

aussi longtemps son tic-tac nous dérangera. Il déchire par son dur rythme le silence de la nuit et ôte à beaucoup de personnes le sommeil reconfortant et attendu avec tant d'ardeur.

C'est donc depuis bien longtemps que l'on cherche à solutionner le problème d'un réveil à marche silencieuse, mais sans vrai succès, jusqu'à ce que Junghans a réussi à créer cette construction satisfaisante sous tous les rapports.

A une distance de 10 à 15 cm seulement de l'oreille du dormeur, la marche de Junghans „Silent“ (sans tic-tac) n'est déjà plus perceptible, même au milieu du silence de la nuit.

Junghans „Silent“, ce réveil sympathique, sera le bienvenu de toutes les personnes empêchées parfois de s'endormir à cause du tic-tac.

Aussi veillera-t-il, tel un serviteur muet, sur votre sommeil pour lui dicter, avec plus de ponctualité que le serviteur le plus ponctuel, la fin à l'heure fixée d'avance, par sa sonnerie claire.

**Ever since Alarms have been in use,**

their ticking has had an annoying effect. Their harsh rhythm severs the quietness of the night and deprives many people of their coveted, refreshing sleep.

The many efforts made in the past to create a noiseless alarm were only partially successful until Junghans, at last, succeeded in solving this problem entirely.

Placed only four inches from the ear of the sleeper, the action of Junghans „Silent“ is imperceptible, even in the quietness of night.

Junghans „Silent“ this appealing alarm, will be welcomed by all those whom the ticking of the alarm hitherto frequently prevented from dropping off the sleep. It will also guard your sleep like a silent servant and will call you by its clear ringing at the desired time, more punctually than the most punctual servant.

**En tanto que el despertador esté en uso,**

en tanto su tique-taque quedará perturbativo. Con su duro ritmo rompe el silencio de la noche, robando a muchísimas personas el sueño reconfortativo y esperado ansiosamente.

Desde hace mucho tiempo se está buscando pues la solución del problema de un despertador a marcha silenciosa, sin lograrlo, sin embargo, hasta que Junghans recientemente ha tenido la suerte de resolverlo por la actual construcción, satisfactoria bajo todos los conceptos.

A una distancia de no más de 10 a 15 cm de la oreja del durmiente, la marcha del Junghans „Silent“ (sin tique-taque) ya no se percibe en medio de la noche silenciosa. Junghans „Silent“ será el bienvenido de cuantas personas que frecuentemente hayan sido impedidas de dormirse por motivo del tique-taque.

Tal un servidor mudo velará el Junghans „Silent“ sobre su sueño, para terminarlo, con mayor puntualidad que el más puntual servidor, en la hora precisa fijada, por su sonería clara.



Reklame- und Sportuhr „Turner“

Advertising and sport-clock „Gymnast“ – Horloge de réclame et de Sport „Gymnaste“  
Reloj de reclamo y de deporte „Gimnasta“



14,5 cm = 5 3/4 inches

8/188

**Rotbraun** – Claret coloured – Brun-rouge – Rojo oscuro

**Der Turner führt mit Pausen schwungvolle Übungen am Reck aus** – The gymnast performs intermittently smart exercises on the horizontal-bar

Le gymnaste exécute à intervalles d'exercices élastics à la barre-fixe

El gimnasta efectua á intervalos bellos ejercicios en la barra alta

**Großes Werk** – Large movement – Grand mouvement – Máquina grande

Zumba

Fußball



18 cm = 7 inches

56/25

**Der Elefant bewegt den Kopf** – Elephant moving its head

L'éléphant remuant la tête

El elefante mueve la cabeza



18 cm = 7 inches

56/26

**Der Fußballspieler stößt den Ball** – Footballplayer kicking the ball

Le joueur de foot-ball envoyant le ballon

El jugador chuta al balón

**1 Tag Wecker, kleines Werk** – 1 day alarm, small movement

30 heures réveil, petit mouvement – 30 horas despertador, máquina pequeña

**Metallgehäuse vernickelt** – Metal cases nickelled – Boîtes métal nickelé – Caja de metal niquelado



Sulu



16 cm - 6 1/4 inches

56/27

Der Neger bewegt die Augen - Negro moving the eyes - Nègre tournant les yeux  
El negro mueve los ojos

Sula



16 cm - 6 1/4 inches

56/31

Die Negerin bewegt die Augen - Negress moving the eyes - Nègresse tournant les yeux - La negra mueve los ojos

Jazzo



18 cm - 7 inches

56/41

Der Neger bewegt die Augen und den Arm  
Negro moving eyes and one arm  
Nègre tournant les yeux et remuant le bras  
El negro mueve los ojos y toca la guitarra

1 Tag Wecker, kleines Werk - 1 day alarm, small movement  
30 heures réveil, petit mouvement - 30 horas despertador, máquina pequeña

Metallgehäuse vernickelt - Nickelled metal case - Boîte métal nickelé - Caja de metal niquelado

Samba



18 cm - 7 inches

56/42

Die Negerin schaukelt die Wiege  
Negress swinging the cradle  
Nègresse berçant  
La negra mece la cuna



Schaukel



18 cm - 7 inches

56/51

Schaukel - See-saw - Escarpolette - Mecedor

Schmied



18 cm - 7 inches

56/52

Schmied - Smith - Forgeron - Herrero

Schuster



18 cm - 7 inches

56/53

Schuster - Shoemaker - Cordonnier - Zapatero

Sensenschärfer



18 cm - 7 inches

56/54

Sensenschärfer - Scythe-sharpener  
Faucheur chaplant la faux - Afilador de guadañas

1 Tag Wecker, kleines Werk - 1 day alarm, small movement  
30 heures réveil, petit mouvement - 30 horas despertador, máquina pequeña

Metallgehäuse vernickelt - Nickelled metal case - Boîte métal nickelé - Caja de metal niquelado



Joker I



18 cm = 7 inches

- 8/9 1 Tag Wecker - 1 day alarm - 30 heures réveil  
30 horas despertador  
8/15 1 Tag Schlagwerk - 1 day strike - 30 heures sonnerie - 30 horas sonería  
8/16 1 Tag Schlagwerk und Wecker - 1 day strike and alarm - 30 heures sonnerie et réveil - 30 horas despertador y sonería

- 8/17 1 Tag Musikwecker, 1 Arie - 1 day musical alarm, 1 air - 30 heures réveil musique, 1 air - 30 horas despertador de música, 1 pieza  
8/18 1 Tag Musikwecker, 2 Arien - 1 day musical alarm, 2 airs - 30 heures réveil musique, 2 airs - 30 horas despertador de música, 2 piezas  
8/19 1 Tag Musikschlagwerk, 1 Arie - 1 day musical strike, 1 air - 30 heures sonnerie musique, 1 air 30 horas sonería á música, 1 pieza

Joker II



18 cm = 7 inches

- 8/20 1 Tag Wecker - 1 day alarm - 30 heures réveil  
30 horas despertador  
8/21 1 Tag Schlagwerk - 1 day strike - 30 heures sonnerie - 30 horas sonería  
8/22 1 Tag Schlagwerk und Wecker - 1 day strike and alarm - 30 heures sonnerie et réveil - 30 horas despertador y sonería  
8/23 1 Tag Musikwecker, 1 Arie - 1 day musical alarm, 1 air - 30 heures réveil musique, 1 air - 30 horas despertador de música, 1 pieza  
8/24 1 Tag Musikwecker, 2 Arien - 1 day musical alarm, 2 airs - 30 heures réveil musique, 2 airs - 30 horas despertador de música, 2 piezas  
8/25 1 Tag Musikschlagwerk, 1 Arie - 1 day musical strike, 1 air - 30 heures sonnerie musique, 1 air 30 horas sonería á música, 1 pieza

Joker III

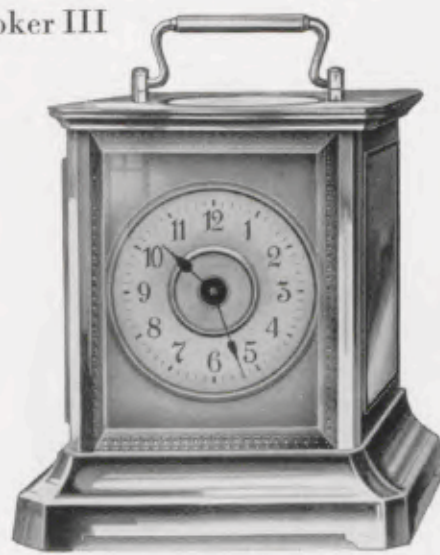

18 cm = 7 inches

- 8/35 1 Tag Wecker - 1 day alarm - 30 heures réveil  
30 horas despertador  
8/36 1 Tag Schlagwerk - 1 day strike - 30 heures sonnerie - 30 horas sonería  
8/37 1 Tag Schlagwerk und Wecker - 1 day strike and alarm - 30 heures sonnerie et réveil - 30 horas despertador y sonería  
8/38 1 Tag Musikwecker, 1 Arie - 1 day musical alarm, 1 air - 30 heures réveil musique, 1 air - 30 horas despertador de música, 1 pieza  
8/39 1 Tag Musikwecker, 2 Arien - 1 day musical alarm, 2 airs - 30 heures réveil musique, 2 airs - 30 horas despertador de música, 2 piezas  
8/40 1 Tag Musikschlagwerk, 1 Arie - 1 day musical strike, 1 air - 30 heures sonnerie musique, 1 air 30 horas sonería á música, 1 pieza

Mit Stahl- (S) oder Messinggehäusen (M)

With steel (S) or brass cases (M) - Avec boîtes acier (S) ou laiton (M) - Con cajas de acero (S) ó de latón (M)



GRUPPE 9

Wecker in Holzgehäusen

Alarm clocks in wooden cases - Réveils en boîtes bois  
Despertadores en cajas de madera



13 x 18 cm = 5 1/8 x 7 1/8 inches

9/131

Eiche - Oak - Chêne - Roble

Kartonblatt - Cardboard dial - Cadran carton - Esfera de cartón



13 x 18 cm = 5 1/8 x 7 1/8 inches

9/132

Nußbaum poliert - Polished walnut - Noyer poli - Nogal pulido

Chrom-Lunette, Silberblatt - Chromium plated bezel, silver dial  
Lunette chromée, cadran argenté - Bisel cromado, esfera plateada

1 Tag Wecker - 1 day alarm - 30 heures réveil - 30 horas cuerda, despertador

9/131: In allen Eichenfarben lieferbar - Can be had in all oak colours

Livrables en toutes teintes de chêne - Se hacen en todos los colores de roble



GRUPPE 10

Schreibtischuhren

Writing table clocks - Pendulettes de bureau - Relojes para escritorio



13,5 x 18,5 cm = 5 1/4 x 7 1/4 inches

10/62 Kaukasisch Nußbaum poliert - Polished Caucasian walnut - Noyer Caucasiens poli - Nogal Cáucaso pulido



15 x 20,5 cm = 6 x 8 inches

10/63 Eiche - Oak - Chêne - Roble



15 x 20,5 cm = 6 x 8 inches

10/64 Zahlen - Figures - Chiffres - Cifras

10/65 Striche - Strokes - Barres - Rayas

Kaukasisch Nußbaum poliert - Polished Caucasian walnut - Noyer Caucasiens poli - Nogal Cáucaso pulido

Chromlunette, Silberblatt - Chromium plated bezel, silver dial - Lunette chromée, cadran argenté  
Bisel cromado, esfera plateada

8 Tag Ankergehwerk mit Echappement

8 day lever time movement - 8 jours simple, échappement à ancre - Máquina 8 días cuerda, escape á áncora



GRUPPE 12

Schiffsuhren

Ship Clocks - Horloges marine - Relojes Marina

Marine



Gehäuse-Durchmesser - Diameter of case  
Diamètre de la cage - Diámetro de la caja  
12/1: 16,5 cm = 6 1/2 inches  
12/2, 12/3: 18,5 cm = 7 1/4 inches  
12/4, 12/5, 12/39, 12/40: 25 cm = 10 inches  
12/6, 12/7, 12/41, 12/42: 29 cm = 11 1/2 inches

Zifferblatt-Durchmesser - Diameter of dial  
Diamètre du cadran - Diámetro de la esfera  
12/1: 10,5 cm = 4 inches  
12/2, 12/3: 11,5 cm = 4 1/2 inches  
12/4, 12/5, 12/39, 12/40: 16,5 cm = 6 inches  
12/6, 12/7, 12/41, 12/42: 20,5 cm = 8 inches

12/1, 12/2, 12/4, 12/6

12/3, 12/5, 12/7

12/39, 12/41

12/40, 12/42

1 Tag Gehwerk

1 Tag Schlagwerk

8 Tag Gehwerk

8 Tag Schlagwerk

1 day time

1 day strike

8 day time

8 day strike

30 heures simple

30 heures sonnerie

8 jours simple

8 jours sonnerie

30 horas movimiento solo

30 horas sonería

8 días movimiento solo

8 días sonería

Nußbaum - Walnut - Noyer - Nogal

Lackblatt - Lacquered dial - Cadran verni - Esfera esmaltada

Flotte

World I

Mit 8 Tag Präzisionswerk - With 8 day precision movement

Avec mouvement de précision, 8 jours - Con máquina de precisión, 8 días cuerda



19,5 cm = 7 1/2 inches

Gehäuse-Durchmesser - Diameter of case  
Diamètre de la cage - Diámetro de la caja

13 cm = 5 inches

Zifferblatt-Durchmesser - Diameter of dial  
Diamètre du cadran - Diámetro de la esfera

Messinggehäuse - Brass case - Boîte laiton  
Caja de latón

12/10 Vernickelt - Nickelled - Nickelé  
Niquelado

Silberblatt - Silver dial - Cadran argenté - Esfera plateada

8 Tag Gehwerk, Echappement mit 4 Steinen - 8 day time, escapement with 4 jewels  
8 jours simple, échappement avec 4 rubis - 8 días cuerda, escape á áncora con 4 rubis



34 cm = 13 1/2 inches

25 cm = 10 inches

12/61 Buche hell - Light beech - Hêtre clair - Haya color claro  
12/62 Mahagonifarbig - Mahogany finish - Teinte acajou  
Color caoba

Lackblatt - Lacquered dial - Cadran verni - Esfera esmaltada



GRUPPE 14

Autouhren

Motor car clocks - Montres pour auto - Relojes para automovil

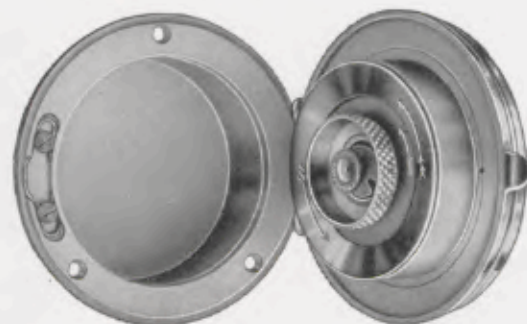
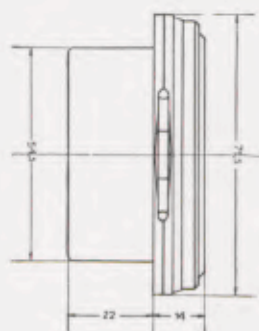

7 cm = 2 3/4 inches

**14/23** 8 Tag Taschenuhr-Präzisionswerk No. J 30, 7steinig, Metallblatt weiß oder schwarz  
8 day precision watch movement No. J 30, 7 jewels, white or black metal dial  
Mouvement de montre de précision No. J 30, 7 rubis, cadran métal blanc ou noir  
Máquina de reloj de bolsillo de precisión No. J 30, 8 días cuerda, 7 rubis, esfera de metal blanca ó negra

Messinggehäuse vernickelt - Brass case nickelled - Boîte laiton nickelé - Caja de latón niquelado

Autouhr mit Scharnier

Motor car clock with hinge - Montre pour auto avec charnière - Reloj para automovil con charnela



Durchmesser 65 mm  
Diameter 65 mm - Diamètre 65 mm - Diámetro 65 mm

14/121

**8 Tag Ankergehwerk No. J 44 ohne Steine**  
8 day lever time movement No. J 44 without jewels  
Mouvement No. J 44, 8 jours simple, échappement à ancre, sans rubis - Máquina No. J 44, 8 días cuerda, escape á áncora, sin rubis

Messinggehäuse vernickelt  
Brass case nickelled - Boîte laiton nickelé  
Caja de latón niquelado

Metallblatt weiß oder schwarz  
White or black metal dial - Cadran métal blanc ou noir  
Esfera de metal blanca ó negra

Mit oder ohne leuchtende Radiumziffern (RZ) - With or without luminous figures (RZ)  
Avec ou sans chiffres lumineux au Radium (RZ) - Con ó sin cifras luminosas Radium (RZ)

Durchmesser 80 mm  
Diameter 80 mm - Diamètre 80 mm - Diámetro 80 mm

14/122

**8 Tag Ankergehwerk No. J 44 ohne Steine**  
8 day lever time movement No. J 44 without jewels  
Mouvement No. J 44, 8 jours simple, échappement à ancre, sans rubis - Máquina No. J 44, 8 días cuerda, escape á áncora, sin rubis

Messinggehäuse vernickelt  
Brass case nickelled - Boîte laiton nickelé  
Caja de latón niquelado

Metallblatt weiß oder schwarz  
White or black metal dial - Cadran métal blanc ou noir  
Esfera de metal blanca ó negra



GRUPPE 17

Kaminuhren

Mantle Clocks - Pendules de cheminée - Relojes de sobremesa

Nr. 203 A

14 Tag Halbstund-Rechenschlagwerk Bim Bam

Neue zweckmäßige Hammerhebung  
Voller, schöner Schlag durch neue  
Hammeranordnung  
Herausnehmbare Federhäuser

Die zweckmäßige Konstruktion erlaubt  
leichtes Reparieren

14 day half-hour rack-strike movement  
Bim Bam

New efficacious hammer-lifting  
Full, nice strike by new arrangement of  
hammers

Interchangeable spring barrels

Easy to repair

Mouvement à râteau 15 jours sonnerie  
heures et demies Bim Bam

Elévation nouvelle et pratique des mar-  
teaux

Sonnerie pleine et belle grâce à une  
nouvelle disposition des marteaux  
Barillets interchangeables

Facile à réparer

Máquina á sierra 15 días sonería horas  
y medias Bim Bam

Elevación nueva y práctica de los martillos  
Sonería plena y bonita que se ha ob-  
tenido por medio de una nueva dis-  
posición de los martillos  
Barilletes intercambiables

Se deja reparar facilmente

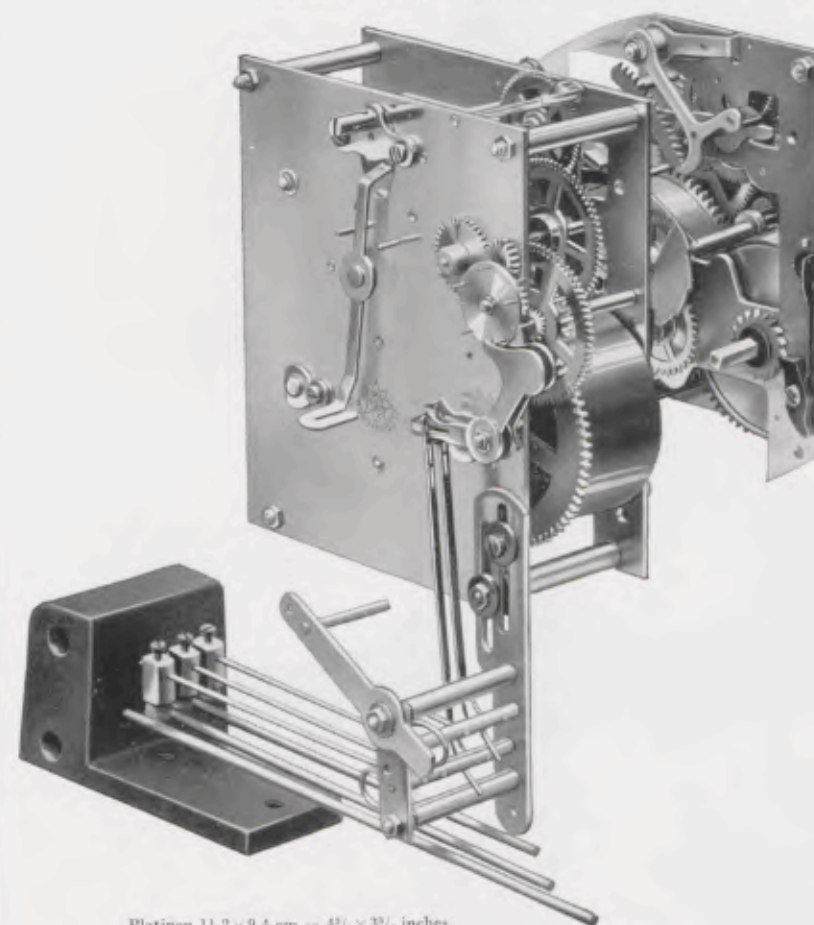

Platinen 11,2 x 9,4 cm = 4 1/2 x 3 3/4 inches

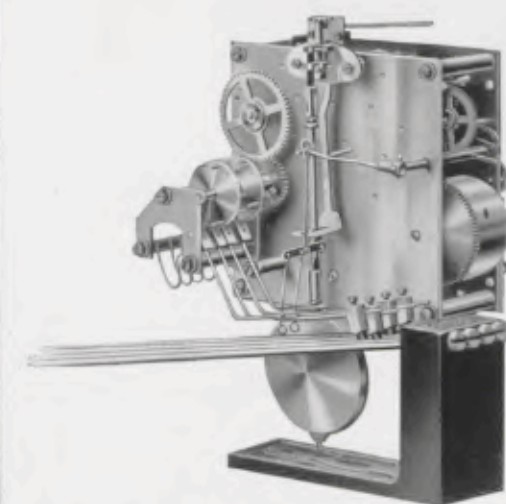

Platinen - Plates  
Platines - Platinas

10,5 x 10,5 cm = 4 1/8 x 4 1/8 inches | 14,5 x 13,5 cm = 5 3/4 x 5 1/4 inches

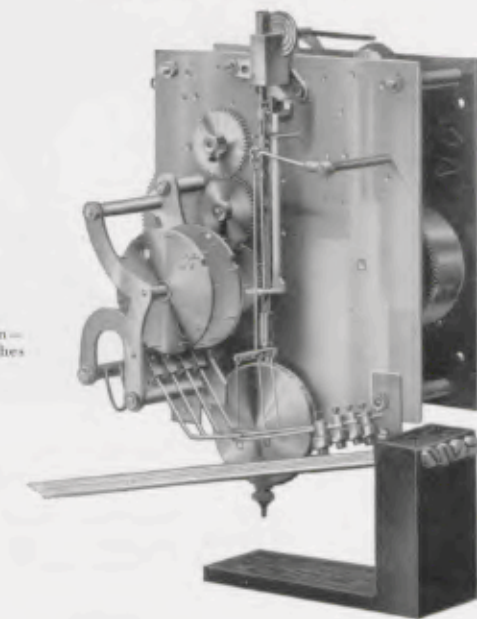

Werk No. 200, 8 Tag 1/4 Westminsterschlag, massive Trieche  
Movt. No. 200, 8 day 1/4 Westminister chime, solid pinions  
Movt. No. 200, 8 jours 1/4 Carillon Westminister, pignons massifs  
Máq. No. 200, 8 días 1/4 Carillon Westminister, piñones macizos

Werk No. 103, 8 Tag 1/4 Westminsterschlag  
Movt. No. 103, 8 day 1/4 Westminister chime  
Movt. No. 103, 8 jours 1/4 Carillon Westminister  
Máq. No. 103, 8 días 1/4 Carillon Westminister



21 x 41 cm = 8 1/2 x 16 1/4 inches

Eiche - Oak - Chêne - Roble

17/516 Rundgong - Gong - Gong rond - Gong redondo  
17/516 B Bachgong - Gong „Bim Bam“



23,5 x 49 cm = 9 1/4 x 19 1/4 inches

Eiche - Oak - Chêne - Roble

17/540 Rundgong - Gong - Gong rond - Gong redondo  
17/540 B Bachgong - Gong „Bim Bam“  
17/540 W 1/4 Westminsterschlag - 1/4 Westminster chime - 1/4 Carillon Westminster

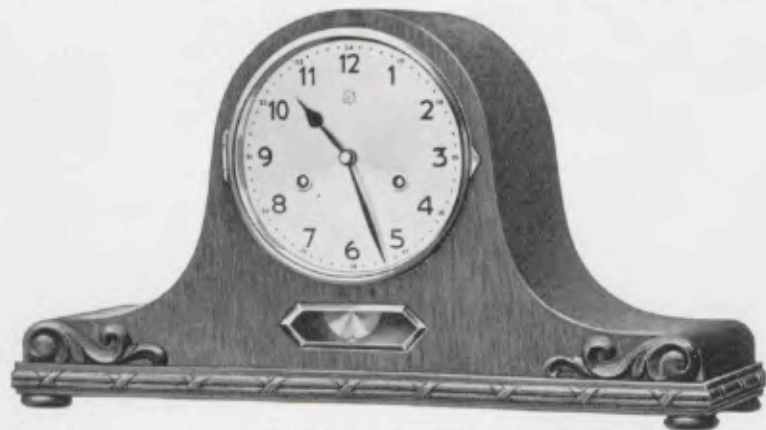

25 x 45,5 cm = 9 7/8 x 17 3/4 inches

Eiche - Oak - Chêne - Roble

17/541 Rundgong - Gong - Gong rond - Gong redondo  
17/541 B Bachgong - Gong „Bim Bam“  
17/541 W 1/4 Westminsterschlag - 1/4 Westminster chime - 1/4 Carillon Westminster

Zifferblatt - Dial - Cadran - Esfera 15 cm = 6 inches

In allen Eichenfarben lieferbar - Can be had in all oak colours  
Livrables en toutes teintes de chêne - Las cajas de roble se hacen en todos los colores



25,5 x 52 cm = 10 x 20 1/4 inches

Eiche - Oak - Chêne - Roble

17/542 Rundgong - Gong - Gong rond - Gong redondo  
17/542 B Bachgong - Gong „Bim Bam“  
17/542 W 1/4 Westminsterschlag - 1/4 Westminster chime - 1/4 Carillon Westminster



26,5 x 52 cm = 10 1/2 x 20 1/2 inches

Eiche - Oak - Chêne - Roble

17/543 Rundgong - Gong - Gong rond - Gong redondo  
17/543 B Bachgong - Gong „Bim Bam“  
17/543 W 1/4 Westminsterschlag - 1/4 Westminster chime - 1/4 Carillon Westminster

Zifferblatt - Dial - Cadran - Esfera 18 cm = 7 inches

In allen Eichenfarben lieferbar - Can be had in all oak colours  
Livrables en toutes teintes de chêne - Las cajas de roble se hacen en todos los colores



27 x 59 cm = 10<sup>3</sup>/<sub>8</sub> x 23<sup>1</sup>/<sub>2</sub> inches

Eiche - Oak - Chêne - Roble

17/544 Rundgong - Gong - Gong rond - Gong redondo    17/544 B Bachgong - Gong „Bim Bam“  
17/544 W <sup>1</sup>/<sub>4</sub> Westminster Schlag - <sup>1</sup>/<sub>4</sub> Westminster chime - <sup>1</sup>/<sub>4</sub> Carillon Westminster



27 x 56 cm = 10<sup>3</sup>/<sub>8</sub> x 22 inches

Eiche - Oak - Chêne - Roble

17/545 Rundgong - Gong - Gong rond - Gong redondo    17/545 B Bachgong - Gong „Bim Bam“  
17/545 W <sup>1</sup>/<sub>4</sub> Westminster Schlag - <sup>1</sup>/<sub>4</sub> Westminster chime - <sup>1</sup>/<sub>4</sub> Carillon Westminster

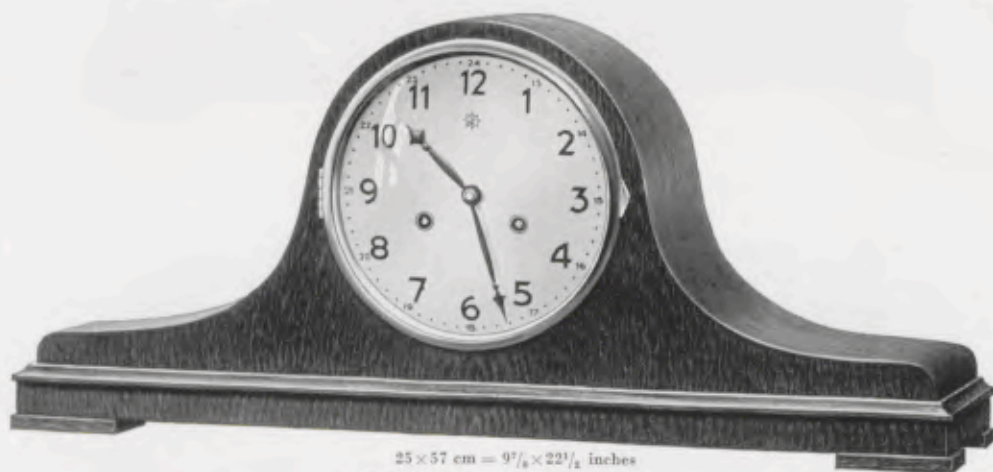

25 x 57 cm = 9<sup>7</sup>/<sub>8</sub> x 22<sup>1</sup>/<sub>2</sub> inches

Eiche - Oak - Chêne - Roble

17/432 Rundgong - Gong - Gong rond - Gong redondo    17/432 B Bachgong - Gong „Bim Bam“  
17/432 W <sup>1</sup>/<sub>4</sub> Westminster Schlag - <sup>1</sup>/<sub>4</sub> Westminster chime - <sup>1</sup>/<sub>4</sub> Carillon Westminster

Zifferblatt - Dial - Cadran - Esfera 18 cm = 7 inches

In allen Eichenfarben lieferbar - Can be had in all oak colours  
Livrables en toutes teintes de chêne - Las cajas de roble se hacen en todos los colores



28,5 x 50,5 cm = 11<sup>1</sup>/<sub>4</sub> x 19<sup>7</sup>/<sub>8</sub> inches

Eiche - Oak - Chêne - Roble

17/546 Rundgong - Gong - Gong rond - Gong redondo  
17/546 B Bachgong - Gong „Bim Bam“  
17/546 W <sup>1</sup>/<sub>4</sub> Westminster Schlag - <sup>1</sup>/<sub>4</sub> Westminster chime - <sup>1</sup>/<sub>4</sub> Carillon Westminster



26,5 x 50 cm = 10<sup>1</sup>/<sub>2</sub> x 19<sup>3</sup>/<sub>4</sub> inches

Eiche - Oak - Chêne - Roble

17/550 Rundgong - Gong - Gong rond - Gong redondo  
17/550 B Bachgong - Gong „Bim Bam“  
17/550 W <sup>1</sup>/<sub>4</sub> Westminster Schlag - <sup>1</sup>/<sub>4</sub> Westminster chime - <sup>1</sup>/<sub>4</sub> Carillon Westminster

Zifferblatt - Dial - Cadran - Esfera 18 cm = 7 inches

In allen Eichenfarben lieferbar - Can be had in all oak colours  
Livrables en toutes teintes de chêne - Las cajas de roble se hacen en todos los colores





27 x 54 cm = 10 1/2 x 21 1/4 inches

Eiche - Oak - Chêne - Roble

- 17/569 Rundgong - Gong - Gong rond - Gong redondo  
 17/569 B Bachgong - Gong „Bim Bam“  
 17/569 W 1/4 Westminsterschlag - 1/4 Westminster chime - 1/4 Carillon Westminster  
 Zifferblatt - Dial - Cadran - Esfera 15 x 18,5 cm = 6 x 7 1/4 inches



31 x 68 cm = 12 1/4 x 26 3/4 inches

Eiche - Oak - Chêne - Roble

- 17/547 Rundgong - Gong - Gong rond - Gong redondo  
 17/547 B Bachgong - Gong „Bim Bam“  
 17/547 W 1/4 Westminsterschlag - 1/4 Westminster chime - 1/4 Carillon Westminster  
 Zifferblatt - Dial - Cadran - Esfera 20 cm = 8 inches

In allen Eichenfarben lieferbar - Can be had in all oak colours  
 Livrables en toutes teintes de chêne - Las cajas de roble se hacen en todos los colores



21 x 41 cm = 8 1/4 x 16 1/4 inches

Nußbaum poliert - Polished walnut - Noyer poli - Nogal pulido

- 17/528 Rundgong - Gong - Gong rond - Gong redondo  
 17/528 B Bachgong - Gong „Bim Bam“  
 Zifferblatt - Dial - Cadran - Esfera 15 cm = 6 inches



25 x 52,5 cm = 9 7/8 x 20 3/4 inches

Nußbaum poliert - Polished walnut - Noyer poli - Nogal pulido

Zahlenreif versilbert - Silvered figure-circle - Cercle à chiffre argenté - Cerco con cifras plateado 18 cm = 7 inches

- 17/548 Rundgong - Gong - Gong rond - Gong redondo  
 17/548 B Bachgong - Gong „Bim Bam“  
 17/548 W 1/4 Westminsterschlag - 1/4 Westminster chime - 1/4 Carillon Westminster

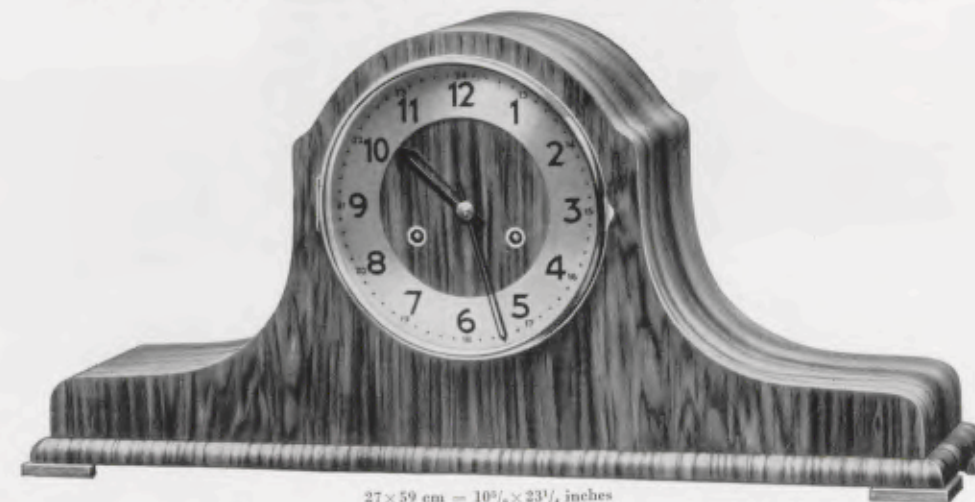

27 x 59 cm = 10 5/8 x 23 1/4 inches

Nußbaum poliert - Polished walnut - Noyer poli - Nogal pulido

Chrom-Lunette, Silber-Zahlenreif - Chromium plated bezel, silver figure-circle  
 Lunette chromée, cercle à chiffre argenté - Bisel cromado, cerco con cifras plateado 18 cm = 7 inches

- 17/549 Rundgong - Gong - Gong rond - Gong redondo  
 17/549 B Bachgong - Gong „Bim Bam“  
 17/549 W 1/4 Westminsterschlag - 1/4 Westminster chime - 1/4 Carillon Westminster



Weston II



26 x 47,5 cm = 10 3/4 x 18 1/2 inches

Mahagoni - Mahogany - Acajou - Caoba

- 17/296 Rundgong - Gong - Gong rond - Gong redondo  
 17/296 B Bachgong - Gong „Bim Bam“  
 17/296 W 1/4 Westminsterschlag - 1/4 Westminster chime - 1/4 Carillon Westminster

Zifferblatt - Dial - Cadran - Esfera 18 cm = 7 inches



25,5 x 35 cm = 10 x 21 1/2 inches

Mahagony - Mahogany - Acajou - Caoba

- 17/459 Rundgong - Gong - Gong rond - Gong redondo  
 17/459 B Bachgong - Gong „Bim Bam“  
 17/459 W 1/4 Westminsterschlag - 1/4 Westminster chime - 1/4 Carillon Westminster

Goldblatt - Gilt dial - Cadran doré - Esfera dorada 15 x 18,5 cm = 6 x 7 1/4 inches



20 x 29 cm = 7 1/4 x 11 1/2 inches

17/509 Eiche - Oak - Chêne - Roble

Chromlunette, Silberblatt  
 Chromium plated bezel, silver dial  
 Lunette chromée, cadran argenté  
 Bisel cromado, esfera plateada



21 x 32 cm = 8 1/4 x 13 inches

17/552 Eiche - Oak - Chêne - Roble

Verchromte Zahlen und Zeiger  
 Chromium plated figures and hands  
 Chiffres et aiguilles chromés  
 Cifras y agujas cromadas

17/578 Kaukasisch Nußbaum matt

Mat Caucasian walnut - Noyer Caucasiens mat  
 Nogal Cáucaso mate

Blaue Zahlen - Blue figures - Chiffres bleus  
 Cifras azules

17/553 Kaukasisch Nußbaum poliert

Polished Caucasian walnut - Noyer Caucasiens poli - Nogal Cáucaso pulido

Blaue Zahlen - Blue figures - Chiffres bleus  
 Cifras azules

Chromlunette, Zahlenreif versilbert, verchromte Zeiger - Chromium plated bezel, silvered figure-circle, chromium plated hands - Lunette chromée, cercle à chiffre argenté, aiguilles chromées  
 Bisel cromado, cerco con cifras plateado, agujas cromadas  
 15 x 15 cm = 6 x 6 inches



20 x 29 cm = 7 1/4 x 11 1/2 inches

Rundgong - Gong - Gong rond - Gong redondo • Bachgong - Gong „Bim Bam“

17/509, 17/552: In allen Eichenfarben lieferbar - Can be had in all oak colours

Livrables en toutes teintes de chêne - Se hacen en todos los colores de roble



21,5 x 34 cm = 8 1/4 x 13 3/8 inches

**17/570 Nußbaum poliert**  
Polished walnut  
Noyer poli  
Nogal pulido

**Verchromte Zahlen und Zeiger**  
Chromium plated figures and hands  
Chiffres et aiguilles chromés  
Cifras y agujas cromadas



20 x 31 cm = 7 7/8 x 12 1/4 inches

**17/568 Nußbaum poliert**  
Polished walnut  
Noyer poli  
Nogal pulido

**Blaue Zahlen - Blue figures - Chiffres bleus**  
Cifras azules

**Chromlünette, Zahlenreif versilbert, verchromte Zeiger** - Chromium plated bezel, silvered figure-circle, chromium plated hands - Lunette chromée, cercle à chiffre argenté, aiguilles chromées - Bisel cromado, cerco con cifras plateado, agujas cromadas  
15 x 15 cm = 6 x 6 inches

**Rundgong - Gong - Gong rond - Gong redondo • Bachgong - Gong „Bim Bam“**

3/4 Westminsterschlag - 3/4 Westminster chime - 3/4 Carillon Westminster



24 x 35,5 cm = 9 1/2 x 14 inches

**17/572 Nußbaum poliert**  
Polished walnut  
Noyer poli  
Nogal pulido

**Verchromte Zahlen und Zeiger**  
Chromium plated figures and hands  
Chiffres et aiguilles chromés  
Cifras y agujas cromadas

**Rundgong - Gong - Gong rond - Gong redondo • Bachgong - Gong „Bim Bam“**



21,5 x 30 cm = 8 1/2 x 11 7/8 inches

**17/554 Kaukasisch Nußbaum matt**  
Mat Caucasian walnut - Noyer Caucasiens mat  
Nogal Cáucaso mate

**Schwarze Zahlen - Black figures**  
Chiffres noirs - Cifras negras

**17/556 Kaukasisch Nußbaum poliert**  
Polished Caucasian walnut - Noyer Caucasiens poli - Nogal Cáucaso pulido

**Blaue Zahlen - Blue figures**  
Chiffres bleus - Cifras azules

**Chromlünette, Zahlenreif versilbert, verchromte Zeiger** - Chromium plated bezel, silvered figure-circle, chromium plated hands - Lunette chromée, cercle à chiffre argenté, aiguilles chromées - Bisel cromado, cerco con cifras plateado, agujas cromadas 17 cm = 6 3/4 inches

**14 Tag Anker-Schlagwerk mit Echappement**  
14 day lever strike movement with escapement  
15 jours sonnerie à ancre avec échappement  
15 días sonería, escape á áncora

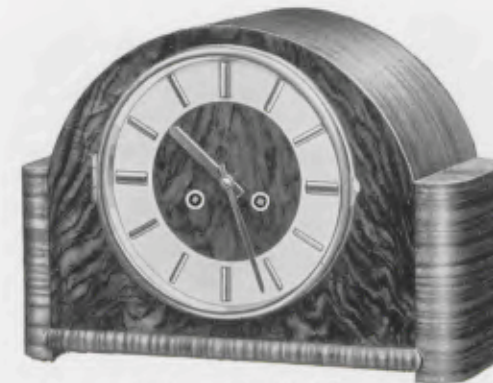

21,5 x 30 cm = 8 1/2 x 11 7/8 inches

**17/557 Kaukasisch Nußbaum poliert**  
Polished Caucasian walnut - Noyer Caucasiens poli - Nogal Cáucaso pulido

**Chromlünette, Zahlenreif versilbert, verchromte Striche und Zeiger** - Chromium plated bezel, silvered figure-circle, chromium plated strokes and hands - Lunette chromée, cercle à chiffre argenté, barres et aiguilles chromées - Bisel cromado, cerco con cifras plateado, rayas y agujas cromadas 17 cm = 6 3/4 inches

**14 Tag Anker-Schlagwerk mit Echappement**  
14 day lever strike movement with escapement  
15 jours sonnerie à ancre avec échappement  
15 días sonería, escape á áncora

**Rundgong - Gong - Gong rond - Gong redondo**  
**Bachgong - Gong „Bim Bam“**



24 x 44 cm = 9 1/2 x 17 1/4 inches

**17/571 Kaukasisch Nußbaum poliert**  
Polished Caucasian walnut  
Noyer Caucasiens poli  
Nogal Cáucaso pulido

**Schwarze Zahlen - Black figures**  
Chiffres noirs - Cifras negras

**Chromlünette, Zahlenreif versilbert, verchromte Zeiger** - Chromium plated bezel, silvered figure-circle, chromium plated hands - Lunette chromée, cercle à chiffre argenté, aiguilles chromées - Bisel cromado, cerco con cifras plateado, agujas cromadas 20 cm = 8 inches

**Rundgong - Gong - Gong rond - Gong redondo**

**Bachgong - Gong „Bim Bam“**

3/4 Westminsterschlag - 3/4 Westminister chime - 3/4 Carillon Westminster

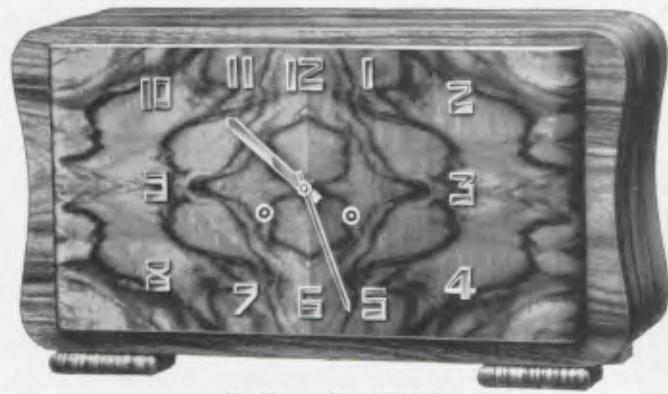

22 x 40 cm = 8 3/4 x 15 3/4 inches

**17/576** Kaukasisch Nußbaum poliert  
Polished Caucasian walnut  
Noyer Caucasiens poli  
Nogal Cáucaso pulido

**Verchromte Zahlen und Zeiger**  
Chromium plated figures and hands  
Chiffres et aiguilles chromés  
Cifras y agujas cromadas

**Rundgong** - Gong - Gong rond  
Gong redondo

**Bachgong** - Gong „Bim Bam“

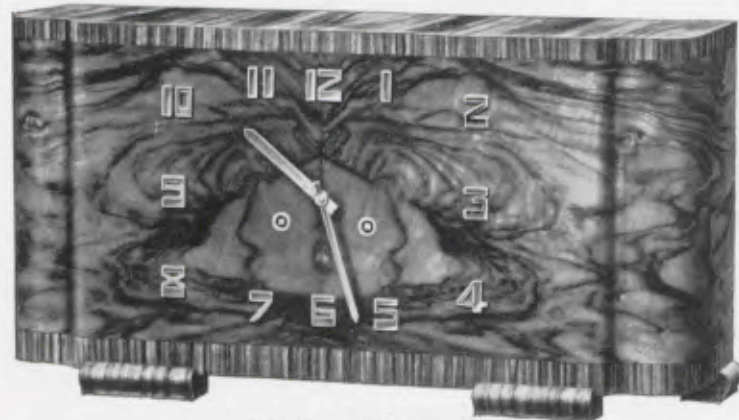

23,5 x 47 cm = 9 1/4 x 18 1/2 inches

**17/575** Kaukasisch Nußbaum poliert  
Polished Caucasian walnut  
Noyer Caucasiens poli  
Nogal Cáucaso pulido

**Verchromte Zahlen und Zeiger**  
Chromium plated figures and hands  
Chiffres et aiguilles chromés  
Cifras y agujas cromadas

**Rundgong** - Gong - Gong rond  
Gong redondo

**Bachgong** - Gong „Bim Bam“

1/4 Westminsterschlag - 1/4 Westminster chime  
1/4 Carillon Westminster



21,5 x 43 cm = 8 1/2 x 17 inches

**17/559** Kaukasisch Nußbaum poliert  
Polished Caucasian walnut  
Noyer Caucasiens poli  
Nogal Cáucaso pulido

**Schwarze Zahlen** - Black figures - Chiffres noirs - Cifras negras

**Chromlunette, Zahlenreif versilbert, verchromte Zeiger**

Chromium plated bezel, silvered figure-circle, chromium plated hands  
Lunette chromée, cercle à chiffre argenté, aiguilles chromées - Bisel cromado, cerco con cifras plateado, agujas cromadas

17 cm = 6 3/4 inches

**Rundgong** - Gong - Gong rond - Gong redondo

**Bachgong** - Gong „Bim Bam“

1/4 Westminsterschlag - 1/4 Westminster chime  
1/4 Carillon Westminster



21 x 32 cm = 8 1/4 x 12 1/2 inches

**17/562** Kaukasisch Nußbaum poliert  
Polished Caucasian walnut  
Noyer Caucasiens poli  
Nogal Cáucaso pulido

**Verchromte Zahlen und Zeiger**  
Chromium plated figures and hands  
Chiffres et aiguilles chromés  
Cifras y agujas cromadas

**Rundgong** - Gong - Gong rond - Gong redondo

**Bachgong** - Gong „Bim Bam“



21,5 x 34 cm = 8 1/2 x 13 3/4 inches

**17/567** Kaukasisch Nußbaum poliert  
Polished Caucasian walnut  
Noyer Caucasiens poli  
Nogal Cáucaso pulido

**Blaue Zahlen** - Blue figures - Chiffres bleus  
Cifras azules

**Chromlunette, Zahlenreif versilbert, verchromte Zeiger** - Chromium plated bezel, silvered figure-circle, chromium plated hands - Lunette chromée, cercle à chiffre argenté, aiguilles chromées  
Bisel cromado, cerco con cifras plateado, agujas cromadas

17 cm = 6 3/4 inches

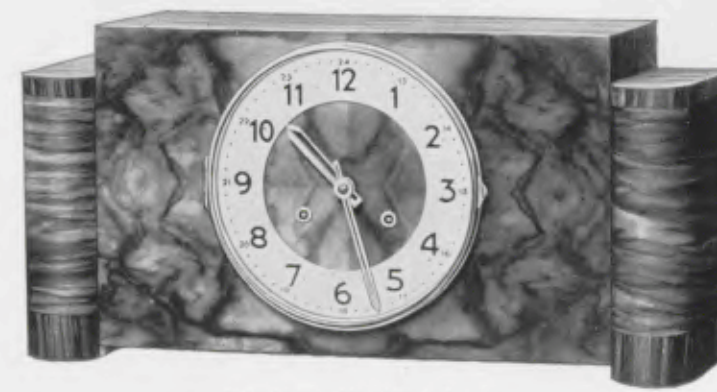

21,5 x 44 cm = 8 1/2 x 17 1/4 inches

**17/577** Kaukasisch Nußbaum poliert  
Polished Caucasian walnut  
Noyer Caucasiens poli  
Nogal Cáucaso pulido

**Schwarze Zahlen** - Black figures - Chiffres noirs - Cifras negras

**Chromlunette, Zahlenreif versilbert, verchromte Zeiger** - Chromium plated bezel, silvered figure-circle, chromium plated hands - Lunette chromée, cercle à chiffre argenté, aiguilles chromées - Bisel cromado, cerco con cifras plateado, agujas cromadas

17 cm = 6 3/4 inches

**Rundgong** - Gong - Gong rond  
Gong redondo

**Bachgong** - Gong „Bim Bam“

1/4 Westminsterschlag - 1/4 Westminster chime  
1/4 Carillon Westminster

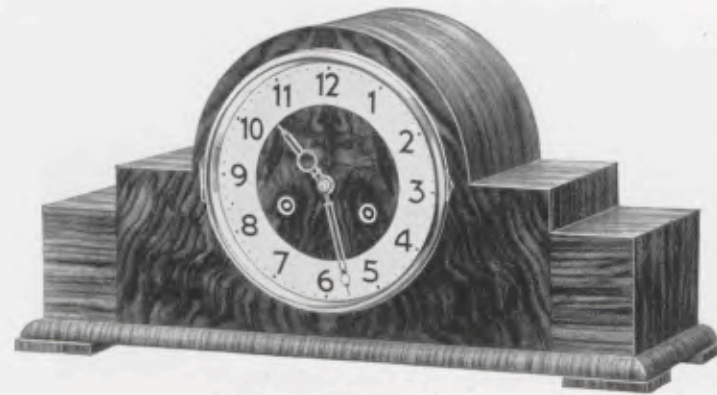

22 x 44 cm = 8 7/8 x 17 1/4 inches

**17/563** Kaukasisch Nußbaum poliert  
Polished Caucasian walnut  
Noyer Caucasien poli  
Nogal Cáucaso pulido

Blau Zahlen - Blue figures - Chiffres bleus - Cifras azules

Chromlünette, Zahlenreif versilbert, verchromte Zeiger  
Chromium plated bezel, silvered figure-circle, chromium plated hands  
Lunette chromée, cercle à chiffre argenté, aiguilles chromées - Bisel cromado, cerco con cifras plateado, agujas cromadas  
17 cm = 6 3/4 inches

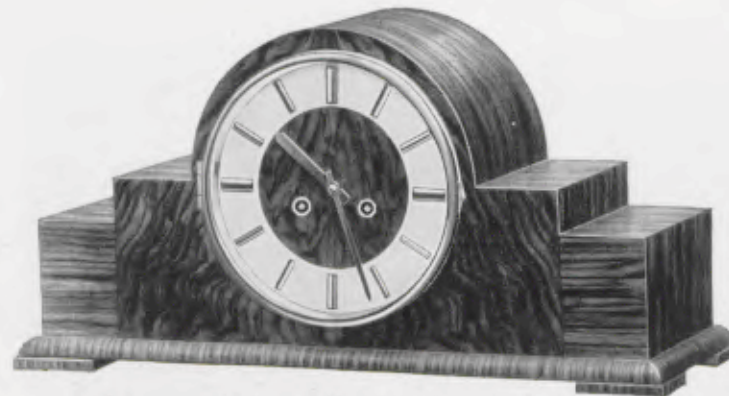

22 x 44 cm = 8 7/8 x 17 1/4 inches

**17/564** Kaukasisch Nußbaum poliert  
Polished Caucasian walnut  
Noyer Caucasien poli  
Nogal Cáucaso pulido

Chromlünette, Zahlenreif versilbert, verchromte Striche und Zeiger  
Chromium plated bezel, silvered figure-circle, chromium plated strokes and hands  
Lunette chromée, cercle à chiffre argenté, barres et aiguilles chromées - Bisel cromado, cerco con cifras plateado, rayas y agujas cromadas  
17 cm = 6 3/4 inches



24,5 x 35,5 cm = 9 5/8 x 14 inches

**17/566** Makassar poliert  
Polished Macassar  
Macassar poli  
Macassar pulido

Zahlenreif versilbert, aufgelegte Goldzahlen  
Silvered figure-circle, gilt raised figures  
Cercle à chiffre argenté, chiffres dorés rapportés  
Cerco con cifras plateado, cifras doradas sobrepuestas  
17 cm = 6 3/4 inches

Rundgong - Gong - Gong rond - Gong redondo \* Bachgong - Gong „Bim Bam“



27 x 28 cm = 10 3/4 x 11 inches

**17/535** Schleiflack schwarz - Varnished black dull  
Peinture noire lacquée dépolie - Barniz pulido mate, negro



22 x 34 cm = 8 1/2 x 13 1/4 inches

**17/534** Schleiflack schwarz - Varnished black dull  
Peinture noire lacquée dépolie - Barniz pulido mate, negro



27 x 28 cm = 10 3/4 x 11 inches

**17/536** Kaukasisch Nußbaum poliert - Polished Caucasian walnut - Noyer Caucasien poli - Nogal Cáucaso pulido



22 x 34 cm = 8 1/2 x 13 1/4 inches

**17/565** Kaukasisch Nußbaum poliert - Polished Caucasian walnut - Noyer Caucasien poli - Nogal Cáucaso pulido

Rundgong - Gong - Gong rond - Gong redondo \* Bachgong - Gong „Bim Bam“

Metallträger und Zeiger verchromt, matt versilberte Striche  
Chromium plated metal stands and hands, mat silvered strokes  
Porteur de métal et aiguilles chromés, barres argentés mat  
Portador de metal y agujas cromados, rayas plateadas mate

**17/535, 17/536:** 14 Tag Anker-Schlagwerk mit Echappement - 14 day lever strike movement with escapement  
15 jours sonnerie à ancre avec échappement - 15 días sonería, escape á áncora



**Einsatzuhren zum Einbauen in Möbel, Büfets usw.**

Dial clocks for fitting in furniture, sideboards etc. — Pendules à encastrer pour meubles, buffets etc. — Relojes para colocar en estantes, muebles etc.

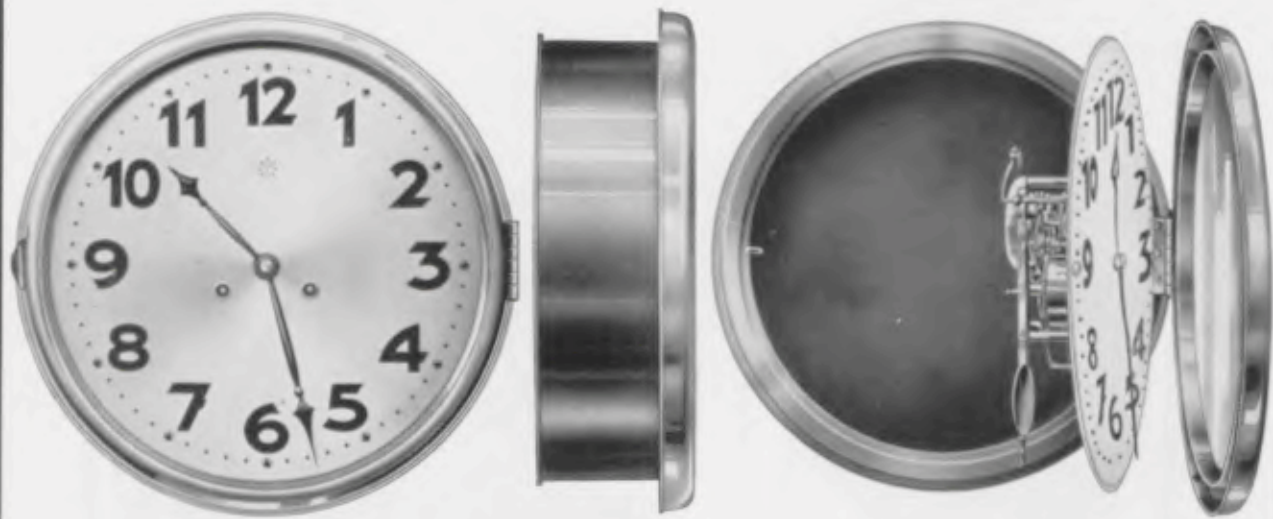

18/2  
18/3

- 18/98 8 Tag Ankerschlagwerk - 8 day lever strike - 8 jours sonnerie à ancre - 8 días sonería, escape à ancóra
- 18/181 8 Tag Ankergehwerk No. 146 - 8 day lever time - 8 jours simple à ancre - 8 días cuerda, escape à ancóra
- 18/1 14 Tag Pendelgehwerk - 14 day pendulum time - 15 jours simple à balancier - Máquina à péndola, 15 días cuerda
- 18/182 8 Tag Ankergehwerk No. 146 - 8 day lever time - 8 jours simple à ancre - 8 días cuerda, escape à ancóra
- 18/2 14 Tag Pendelgehwerk - 14 day pendulum time - 15 jours simple à balancier - Máquina à péndola, 15 días cuerda
- 18/3 14 Tag Pengelschlagwerk auf Glocke - 14 day strike on bell - 15 jours sonnerie sur timbre - Máquina à péndola, 15 días sonería sobre campana

Chromlunetten - Chromium plated bezels - Lunettes chromées - Biseles cromados

Abmessungen - Dimensions - Dimensions - Dimensiones

No. No. No. No.	Silberblatt - Silver dial - Cadran argenté - Esfera plateada		Hintergehäuse - Back case - Tambour - Caja	
	Minutenkreisdurchmesser Diameter of minute circle Diamètre du cercle minutes Diámetro del círculo de minutos	Lunettendurchmesser Diameter of bezel Diamètre extér. de la lunette Diámetro total del bisel	Durchmesser Diameter Diamètre Diámetro	Tiefe Depth Profondeur Profundidad
18/98	164 mm = 6 1/2 inches	210 mm = 8 1/4 inches	180 mm = 7 inches	63 mm = 2 1/2 inches
18/181	164 " = 6 1/2 "	210 " = 8 1/4 "	180 " = 7 "	63 " = 2 1/2 "
18/1	225 " = 9 "	275 " = 10 7/8 "	232 " = 9 1/8 "	80 " = 3 1/8 "
18/182	225 " = 9 "	275 " = 10 7/8 "	232 " = 9 1/8 "	80 " = 3 1/8 "
18/2	262 " = 10 "	332 " = 13 1/8 "	280 " = 11 "	80 " = 3 1/8 "
18/3	262 " = 10 "	332 " = 13 1/8 "	280 " = 11 "	80 " = 3 1/8 "



Agnes



Glaszifferblatt  
Glass dial - Cadran verre - Esfera de vidrio

Rahmen - Frame - Cadre - Marco		Zifferblatt - Dial - Cadran - Esfera
Buche, hell poliert Light beech polished Hêtre clair poli Haya clara pulida	Nußbaumfarbig oder schwarz Walnut finish or black Teinte noyer ou noire Color nogal ó negro	Minutenkreisdurchmesser Diameter of minute circle Diamètre du cercle minutes Diámetro del círculo de minutos
18/202	18/203	276 = 11 mm inches 184 = 7 mm inches
18/204	18/206	8 Tag Pendel-Gehwerk - 8 day pendulum time - 8 jours simple à balancier - 8 días cuerda à péndola
18/205	18/207	14 Tag Gehwerk - 14 day time - 15 jours simple - 15 días cuerda 14 Tag Schlagwerk - 14 day strike - 15 jours sonnerie - 15 días sonería
18/208	18/210	315 = 12 1/2 mm inches 216 = 8 1/2 mm inches
18/209	18/211	14 Tag Gehwerk - 14 day time - 15 jours simple - 15 días cuerda 14 Tag Schlagwerk - 14 day strike - 15 jours sonnerie - 15 días sonería
18/212	18/214	364 = 14 1/4 mm inches 262 = 10 mm inches
18/213	18/215	14 Tag Gehwerk - 14 day time - 15 jours simple - 15 días cuerda 14 Tag Schlagwerk - 14 day strike - 15 jours sonnerie - 15 días sonería

18/202-203: mit Blechhinterkasten - with metal case - avec boîte en tôle - con caja de metal



Altai



Zelluloid-Zifferblatt, bombiertes Glas  
Celluloid dial, convex glass - Cadran celluloid, verre bombé - Esfera de celuloide, cristal bombado

Rahmen - Frame - Cadre - Marco			Zifferblatt - Dial - Cadran - Esfera	
Buche hell poliert Light beech polished Hêtre clair poli Haya clara pulida	Nußbaumfarbig oder schwarz Walnut finish or black Teinte noyer ou noir Color nogal ó negro	Weiß lackiert White lacquered Verni blanc Barnizado en blanco	Durchmesser Diameter Diamètre Diámetro	Minutenkreisdurchmesser Diameter of minute circle Diamètre du cercle minutes Diámetro del círculo de minutos
18,216	18,217		276 = 11 mm inches	184 = 7 mm inches
18,218	18,220	18,235	8 Tag Pendel-Gehwerk - 8 day pendulum time - 8 jours simple à balancier - 8 días cuerda a péndola	
18,219	18,221	18,236	14 Tag Gehwerk - 14 day time - 15 jours simple - 15 días cuerda	
			14 Tag Schlagwerk - 14 day strike - 15 jours sonnerie - 15 días sonería	
18,222	18,224		315 = 12 <sup>1</sup> / <sub>2</sub> mm inches	216 = 8 <sup>1</sup> / <sub>2</sub> mm inches
18,223	18,225		14 Tag Gehwerk - 14 day time - 15 jours simple - 15 días cuerda	
			14 Tag Schlagwerk - 14 day strike - 15 jours sonnerie - 15 días sonería	
18,226	18,228		364 = 14 <sup>1</sup> / <sub>2</sub> mm inches	262 = 10 mm inches
18,227	18,229		14 Tag Gehwerk - 14 day time - 15 jours simple - 15 días cuerda	
			14 Tag Schlagwerk - 14 day strike - 15 jours sonnerie - 15 días sonería	
18,230	18,232		400 = 15 <sup>3</sup> / <sub>4</sub> mm inches	305 = 12 mm inches
18,231	18,233		14 Tag Gehwerk - 14 day time - 15 jours simple - 15 días cuerda	
			14 Tag Schlagwerk - 14 day strike - 15 jours sonnerie - 15 días sonería	



Buenos-Aires



Messinglunette, Lackblatt  
Brass bezel, lacquered dial - Lunette laiton, cadran verni - Bisel de latón, esfera esmaltada

Rahmen - Frame - Cadre - Marco			Zifferblatt - Dial - Cadran - Esfera	
Eiche Oak Chêne Roble	Nußbaumfarbig oder schwarz Walnut finish or black Teinte noyer ou noir Color nogal ó negro	Durchmesser Diameter Diamètre Diámetro	Minutenkreisdurchmesser Diameter of minute circle Diamètre du cercle minutes Diámetro del círculo de minutos	
18,133	18,135	34 = 13 <sup>1</sup> / <sub>2</sub> cm inches	184 = 7 mm inches	
18,134	18,136	14 Tag Gehwerk - 14 day time - 15 jours simple - 15 días cuerda		
		14 Tag Schlagwerk - 14 day strike - 15 jours sonnerie - 15 días sonería		
18,137	18,139	38 = 15 cm inches	225 = 9 mm inches	
18,138	18,140	14 Tag Gehwerk - 14 day time - 15 jours simple - 15 días cuerda		
		14 Tag Schlagwerk - 14 day strike - 15 jours sonnerie - 15 días sonería		
18,141	18,143	46 = 18 cm inches	262 = 10 mm inches	
18,142	18,144	14 Tag Gehwerk - 14 day time - 15 jours simple - 15 días cuerda		
		14 Tag Schlagwerk - 14 day strike - 15 jours sonnerie - 15 días sonería		
18,145	18,147	52 = 20 <sup>1</sup> / <sub>2</sub> cm inches	305 = 12 mm inches	
18,146	18,148	14 Tag Gehwerk - 14 day time - 15 jours simple - 15 días cuerda		
		14 Tag Schlagwerk - 14 day strike - 15 jours sonnerie - 15 días sonería		



World II



Afrika



Lackblatt - Lacquered dial - Cadran verni - Esfera esmaltada

Rahmen - Frame - Cadre - Marco

Zifferblatt - Dial - Cadran - Esfera

Buche hell Light beech Hêtre clair Haya color claro	Mahagonifarbig Mahogany finish Teinte acajou Color caoba	Eiche Oak Chêne Roble	Durchmesser Diameter Diamètre Diámetro	Minutenkreisdurchmesser Diameter of minute circle Diamètre du cercle minutes Diámetro del círculo de minutos
World 18,173 18,174	World 18,175 18,176		30 = 11 <sup>3</sup> / <sub>4</sub> cm inches	184 = 7 mm inches 14 Tag Gehwerk - 14 day time - 15 jours simple - 15 días cuerda 14 Tag Schlagwerk - 14 day strike - 15 jours sonnerie - 15 días sonería Messinglunette - Brass bezel - Lunette laiton - Bisel de latón
World 18,169 18,170	World 18,171 18,172		34 = 13 <sup>1</sup> / <sub>2</sub> cm inches	225 = 9 mm inches 14 Tag Gehwerk - 14 day time - 15 jours simple - 15 días cuerda 14 Tag Schlagwerk - 14 day strike - 15 jours sonnerie - 15 días sonería Messinglunette - Brass bezel - Lunette laiton - Bisel de latón
World 18,100 18,101	World 18,102 18,103		38,5 = 15 cm inches	280 = 11 mm inches 14 Tag Gehwerk - 14 day time - 15 jours simple - 15 días cuerda 14 Tag Schlagwerk - 14 day strike - 15 jours sonnerie - 15 días sonería Messinglunette - Brass bezel - Lunette laiton - Bisel de latón
		Afrika 18,91 18,92	54 = 21 cm inches	360 = 14 mm inches 14 Tag Gehwerk - 14 day time - 15 jours simple - 15 días cuerda 14 Tag Schlagwerk - 14 day strike - 15 jours sonnerie - 15 días sonería
		Afrika 18,93 18,94	64 = 25 cm inches	445 = 17 <sup>1</sup> / <sub>2</sub> mm inches 14 Tag Gehwerk - 14 day time - 15 jours simple - 15 días cuerda 14 Tag Schlagwerk - 14 day strike - 15 jours sonnerie - 15 días sonería



30 cm = 11 <sup>3</sup>/<sub>4</sub> inches

18,245 Verchromt, Makassarblatt matt  
Chromium plated, Macassar-dial, mat  
Chromé, cadran en Macassar, mat  
Cromado, esfera de Macassar, mate

Verchromte Striche und Zeiger - Chromium plated strokes and hands - Barres et aiguilles chromées - Rayas y agujas cromadas

8 Tag Ankergehwerk mit Echappement  
8 day lever time movement with escapement  
8 jours simple, échappement à ancre - Máquina 8 días cuerda, escape á áncora



29 cm = 11 <sup>1</sup>/<sub>2</sub> inches

18,244 Nußbaum poliert - Polished walnut - Noyer poli - Nogal pulido

Verchromte Zahlen und Zeiger - Chromium plated figures and hands - Chiffres et aiguilles chromées - Cifras y agujas cromadas

8 Tag Ankergehwerk mit Echappement - 8 day lever time movement with escapement - 8 jours simple, échappement à ancre - Máquina 8 días cuerda, escape á áncora



33 x 33 cm = 13 x 13 inches

18,199 Eiche - Oak - Chêne - Roble

Silberblatt - Silver dial - Cadran argenté  
Esfera plateada 23 cm = 9 inches

14 Tag Gehwerk oder 14 Tag Schlagwerk mit Waldgong - 14 day time or 14 day strike on Waldgong - 15 jours simple ou 15 jours sonnerie sur Waldgong - 15 días cuerda sin, ó 15 días cuerda con sonería sobre Waldgong

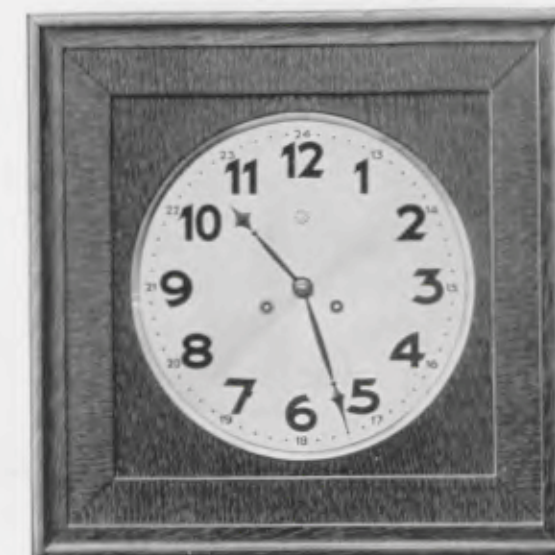

43,5 x 43,5 cm = 17 <sup>1</sup>/<sub>8</sub> x 17 <sup>1</sup>/<sub>8</sub> inches

18,200 Eiche - Oak - Chêne - Roble

Silberblatt - Silver dial - Cadran argenté  
Esfera plateada 25,5 cm = 10 inches

14 Tag Gehwerk oder 14 Tag Schlagwerk mit Waldgong - 14 day time or 14 day strike on Waldgong - 15 jours simple ou 15 jours sonnerie sur Waldgong - 15 días cuerda sin, ó 15 días cuerda con sonería sobre Waldgong





25 x 30 cm = 9 7/8 x 11 7/8 inches

18,246



25 x 30 cm = 9 7/8 x 11 7/8 inches

18,247



25 x 30 cm = 9 7/8 x 11 7/8 inches

18,248

Holzgehäuse matt lackiert - Mat lacquered wooden cases  
Cages en bois lacqué mat - Cajas de madera barnizado mate

Verchromte Zahlen und Zeiger - Chromium plated figures and hands  
Chiffres et aiguilles chromés - Cifras y agujas cromadas

8 Tag Ankergehwerk mit Echappement - 8 day lever time with escapement  
8 jours simple, échappement à ancre - Máquina 8 días cuerda, escape á áncora



Calcutta



40,5 x 24,5 cm = 16 x 9 1/2 inches

18,71

Rangoon



49 x 31 cm = 19 1/4 x 12 1/4 inches

18,96

Lackblatt - Lacquered dial - Cadran verni - Esfera esmaltada

Name Name Nom Nombre	Rahmen - Frame - Cadre - Marco		Zifferblatt - Dial - Cadran - Esfera	
	Buche hell Light beech Hêtre clair Haya color claro	Mahagonifarbig Mahogany finish Teinte arajou Color caoba	Durchmesser Diameter Diamètre Diámetro	Minutenkreisdurchmesser Diameter of minute circle Diamètre du cercle minutes Diámetro del círculo de minutos
Calcutta	18,71	—	24,5 cm = 9 1/2 inches	139 mm = 5 1/2 inches
Rangoon	—	18,96	31 cm = 12 1/4 inches	184 mm = 7 inches

14 Tag Schlagwerk mit Tonfeder  
14 day strike - 15 jours sonnerie sur ressort timbre - 15 días sonería sobre timbre bordón



Bangalore



60 x 38 cm = 23 1/2 x 15 inches

18/110

Haidarabad



60 x 37 cm = 23 1/2 x 14 1/2 inches

18/111

Lackblatt - Lacquered dial - Cadran verni - Esfera esmaltada

Name Name Nom Nombre	Rahmen - Frame - Cadre - Marco		Zifferblatt - Dial - Cadran - Esfera
	Nußbaum Walnut Noyer Nogal	Durchmesser Diameter Diamètre Diámetro	Minutenkreisdurchmesser Diameter of minute circle Diamètre du cercle minutes Diámetro del círculo de minutos
Bangalore	18/110	38 cm = 15 inches	262 mm = 10 inches
Haidarabad	18/111	37 cm = 14 1/2 inches	262 mm = 10 inches

14 Tag Schlagwerk mit Tonfeder

14 day strike - 15 jours sonnerie sur ressort timbre - 15 días sonería sobre timbre bordón



Office



65 x 41 cm = 25 1/2 x 16 inches

18/42

Soerabaya



81 x 43 cm = 32 x 17 inches

18/89

Lackblatt - Lacquered dial - Cadran verni - Esfera esmaltada

Name Name Nom Nombre	Zifferblatt - Dial - Cadran - Esfera	Rahmen - Frame - Cadre - Marco	
	Nußbaum poliert Polished walnut Noyer poli Nogal pulido	Durchmesser Diameter Diamètre Diámetro	Minutenkreisdurchmesser Diameter of minute circle Diamètre du cercle minutes Diámetro del círculo de minutos
Office	18/42	41 cm = 16 inches	262 mm = 10 inches
	Schwarze und goldfarbige Verzierungen - Black and gold coloured metal decorations Garniture couleur noir et or - Adornos negros y de color oro		
Soerabaya	18/89	43 cm = 17 inches	262 mm = 10 inches

14 Tag Schlagwerk mit Tonfeder

14 day strike - 15 jours sonnerie sur ressort timbre - 15 días sonería sobre timbre bordón



GRUPPE 19

*Küchenuhren in Steingut*

Kitchen and Nursery Clocks in earthenware cases – Pendules pour cuisine, cages en faïence – Relojes para cocina, cajas en loza



20 cm = 7 7/8 inches

19/305

**1 Tag Ankergehwerk**

1 day lever time movement

Mouvement 30 heures simple à ancre  
Máquina 30 horas cuerda á âncora



20 cm = 7 7/8 inches

19/306

**1 Tag Ankergehwerk**

1 day lever time movement

Mouvement 30 heures simple à ancre  
Máquina 30 horas cuerda á âncora



20 cm = 7 7/8 inches

19/308

**1 Tag Ankergehwerk**

1 day lever time movement

Mouvement 30 heures simple à ancre  
Máquina 30 horas cuerda á âncora

19/307

**8 Tag Pendelgehwerk**

8 day pendulum time movement  
Mouvement 8 jours simple à balancier  
Máquina 8 días cuerda á péndola

19/309

**8 Tag Pendelgehwerk**

8 day pendulum time movement  
Mouvement 8 jours simple à balancier  
Máquina 8 días cuerda á péndola



24 cm = 9 1/2 inches

19/310

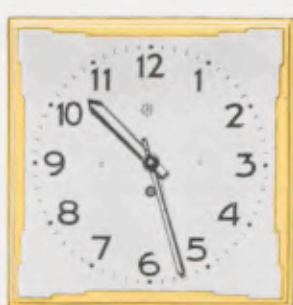

24 cm = 9 1/2 inches

19/311



24 cm = 9 1/2 inches

19/313

**8 Tag Pendelgehwerk** – 8 day pendulum time movement

Mouvement 8 jours simple à balancier – Máquina 8 días cuerda á péndola



24 cm = 9 1/2 inches

19/312

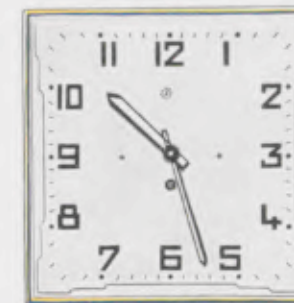

24 cm = 9 1/2 inches

19/314



24 cm = 9 1/2 inches

19/325

Goldlinie – Gilt line  
Filet doré – Línea dorada

**8 Tag Pendelgehwerk** – 8 day pendulum time movement

Mouvement 8 jours simple à balancier – Máquina 8 días cuerda á péndola



24 cm = 9 1/2 inches

19/317



24 cm = 9 1/2 inches

19/315

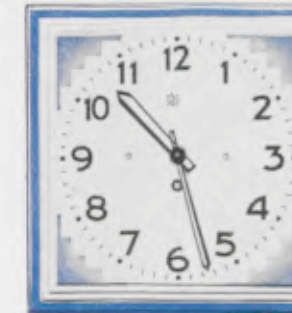

24 cm = 9 1/2 inches

19/318

**8 Tag Pendelgehwerk**

8 day pendulum time movement  
Mouvement 8 jours simple à balancier  
Máquina 8 días cuerda á péndola

**8 Tag Pendelgehwerk**

8 day pendulum time movement  
Mouvement 8 jours simple à balancier  
Máquina 8 días cuerda á péndola

**8 Tag Pendelgehwerk**

8 day pendulum time movement  
Mouvement 8 jours simple à balancier  
Máquina 8 días cuerda á péndola

19/316

**8 Tag Ankergehwerk**  
8 day lever time movement  
Mouvement 8 jours simple à ancre  
Máquina 8 días cuerda á âncora



24 cm = 9 1/2 inches

19/319

8 Tag Pendelgehwerk  
8 day pendulum time movement  
Mouvement 8 jours simple à balancier  
Máquina 8 días cuerda á péndola

19/320

8 Tag Ankergehwerk  
8 day lever time movement  
Mouvement 8 jours simple à ancre  
Máquina 8 días cuerda á áncora



25 cm = 9 7/8 inches

19/294

8 Tag Pendelgehwerk  
8 day pendulum time movement  
Mouvement 8 jours simple à balancier  
Máquina 8 días cuerda á péndola



25 cm = 9 7/8 inches

19/292

8 Tag Pendelgehwerk  
8 day pendulum time movement  
Mouvement 8 jours simple à balancier  
Máquina 8 días cuerda á péndola

19/301

8 Tag Ankergehwerk  
8 day lever time movement  
Mouvement 8 jours simple à ancre  
Máquina 8 días cuerda á áncora

Ziffern und Striche Relief - Raised figures and strokes  
Chiffres et barres en relief - Cifras y rayas en relieve



28 cm = 11 inches

19/321

8 Tag Pendelgehwerk  
8 day pendulum time movement  
Mouvement 8 jours simple à balancier  
Máquina 8 días cuerda á péndola

19/322

14 Tag Pendelgehwerk  
14 day pendulum time movement  
Mouvement 15 jours simple à balancier  
Máquina 15 días cuerda á péndola



28 cm = 11 inches

19/323

8 Tag Pendelgehwerk  
8 day pendulum time movement  
Mouvement 8 jours simple à balancier  
Máquina 8 días cuerda á péndola

19/324

14 Tag Pendelgehwerk  
14 day pendulum time movement  
Mouvement 15 jours simple à balancier  
Máquina 15 días cuerda á péndola



28 cm = 11 inches

19/326

8 Tag Pendelgehwerk  
8 day pendulum time movement  
Mouvement 8 jours simple à balancier  
Máquina 8 días cuerda á péndola

19/327

14 Tag Pendelgehwerk  
14 day pendulum time movement  
Mouvement 15 jours simple à balancier  
Máquina 15 días cuerda á péndola



24 cm = 9 1/2 inches

19/328 1 Tag Ankergehwerk - 1 day lever time movement - Mouvement 30 heures simple à ancre - Máquina 30 horas cuerda á áncora



24 cm = 9 1/2 inches

19/329 8 Tag Pendelgehwerk - 8 day pendulum time movement - Mouvement 8 jours simple à balancier - Máquina 8 días cuerda á péndola



22 x 22 cm = 8 1/4 x 8 1/4 inches

19/332

8 Tag Ankergehwerk mit Echappement - 8 day lever time movement with escapement 8 jours simple, échappement à ancre - Máquina 8 días cuerda, escape á áncora



22 x 22 cm = 8 1/4 x 8 1/4 inches

19/333

Forelle



31 cm = 12 inches

Metallgehäuse - Metal case - Boîte métal - Caja de metal

19/27 Braun lackiert mit Lünette - Brown lacquered with bezel  
Laqué brun avec lunette - Barnizado color marrón con bisel

19/28 Weiß lackiert mit Lünette - White lacquered with bezel  
Laqué blanc avec lunette - Barnizado color blanco con bisel

Bombiertes Glas - Convex glass - Verre bombé - Cristal bombeado

8 Tag Pendelgehwerk - Movement 8 day pendulum time - Mouvement 8 jours simple à balancier  
Máquina 8 días cuerda á péndola



24 x 29 cm = 9 1/2 x 11 3/8 inches

19/335



24 x 29 cm = 9 1/2 x 11 3/8 inches

19/336



29 x 29 cm = 11 3/8 x 11 3/8 inches

19/337



29 x 29 cm = 11 3/8 x 11 3/8 inches

19/338



29 x 29 cm = 11 3/8 x 11 3/8 inches

19/339

8 Tag Ankergehwerk mit Echappement - 8 day lever time movement with escapement  
8 jours simple, échappement à ancre - Máquina 8 días cuerda, escape á âncora



20/4



20/5

Rahmen - Frame  
Cadre - Marco  
21.5 cm = 8 1/2 inches

1 Tag Schlagwerk auf Glocke  
1 day strike on bell  
30 heures sonnerie sur cloche  
30 horas sonería sobre campana

Rahmen nußbaumfarbig, Glaszifferblatt - Frame walnut finish, glass dial  
Cadre teinte noyer, cadran verre - Marco color nogal, esfera de vidrio

Messing-Garnitur - Brass fittings - Garniture laiton - Orladura de latón



Rahmen - Frame  
Cadre - Marco  
21,5 cm = 8 1/2 inches



20/6 Zahlen - Figures - Chiffres - Cifras  
20/7 Striche - Strokes - Barres - Rayas

20/8 Zahlen - Figures - Chiffres - Cifras  
20/9 Striche - Strokes - Barres - Rayas

1 Tag Schlagwerk auf Glocke  
1 day strike on bell  
30 heures sonnerie sur cloche  
30 horas soneria sobre campana

Holz-Rahmen, matt lackiert, Glaszifferblatt - Wooden frame, mat lacquered, glass dial  
Cadre en bois, laqué mat, cadran verre - Marco de madera, barnizado mate, esfera de vidrio

Messing-Garnitur - Brass fittings - Garniture laiton - Orladura de latón



GRUPPE 21

Regulateure

Regulators - Régulateurs - Reguladores

Mosel I



68 x 27 cm = 26 3/4 x 10 1/2 inches

21/2

Mosel II



64 x 27 cm = 25 1/4 x 10 1/2 inches

21/10

Mosel III



68 x 27 cm = 26 3/4 x 10 1/2 inches

21/12

Zelluloidblatt - Celluloid dial - Cadran celluloid - Esfera de celuloide 12,6 cm = 5 inches

Nußbaum poliert, 14 Tag Schlagwerk  
Polished walnut, 14 day strike - Noyer poli, 15 jours sonnerie - Nogal pulido, 15 días soneria



Oder IV



91 x 32 cm = 35 3/4 x 12 1/2 inches

21/14

Weser



89,5 x 35 cm = 34 1/2 x 13 3/4 inches

21/32

Zelluloidblatt - Celluloid dial - Cadran celluloid - Esfera de celuloide 14,5 cm = 5 3/4 inches

Nußbaum poliert, 14 Tag Schlagwerk

Polished walnut, 14 day strike - Noyer poli, 15 jours sonnerie - Nogal pulido, 15 días sonería



Elbe II



96 x 35 cm = 37 3/4 x 13 3/4 inches

21/40

Isar

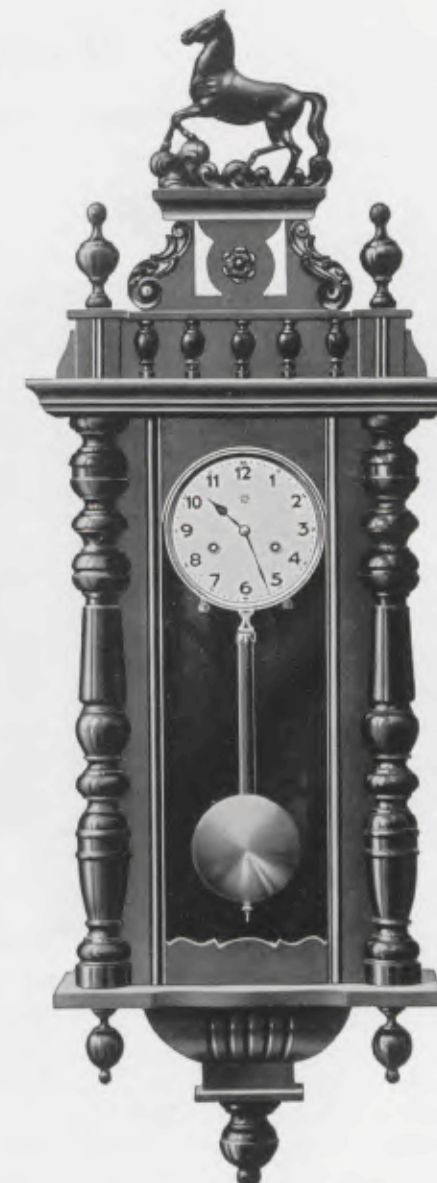

108 x 39 cm = 42 1/2 x 15 1/4 inches

21/53 Auch mit Adleraufsatz lieferbar  
Also with eagle instead of horse  
Livrabile aussi avec aigle au lieu du cheval  
Se suministra también con aderezo de águila

Zelluloidblatt - Celluloid dial - Cadran celluloid - Esfera de celuloide 14,5 cm = 5 3/4 inches

Nußbaum poliert, 14 Tag Schlagwerk

Polished walnut, 14 day strike - Noyer poli, 15 jours sonnerie - Nogal pulido, 15 días sonería

Glasseiten - Glass sides - Côtés en verre - Lados en vidrio



GRUPPEN 23, 24, 25

Wanduhren

Regulators - Régulateurs - Reguladores

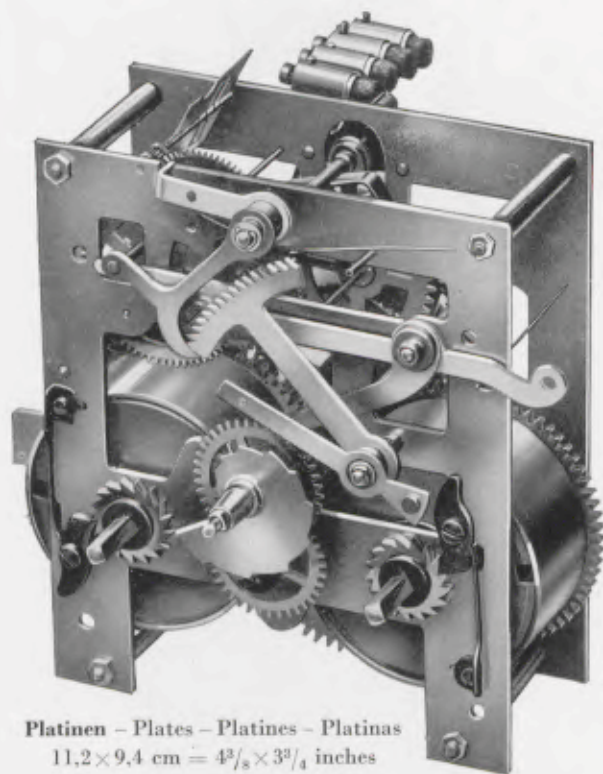

Platinen - Plates - Platines - Platinas  
11,2 x 9,4 cm = 4<sup>3</sup>/<sub>8</sub> x 3<sup>3</sup>/<sub>4</sub> inches

No. 202 A

14 Tag Halbstund-Rechenschlagwerk auf Gong und Bim Bam - Neue zweckmäßige Hammerhebung - Voller, schöner Schlag durch neue Hammeranordnung - Herausnehmbare Federhäuser - Die zweckmäßige Konstruktion erlaubt leichtes Reparieren

14 day half-hour rack-strike movement on Gong and Bim Bam - New efficacious hammer-lifting - Full, nice strike by new arrangement of hammers - Interchangeable spring barrels - Easy to repair

Mouvement à râteau 15 jours sonnerie heures et demies sur Gong et Bim Bam - Elévation nouvelle et pratique des marteaux - Sonnerie pleine et belle grâce à une nouvelle disposition des marteaux - Barillets interchangeables - Facile à réparer

Máquina á sierra 15 días sonería horas y medias sobre Gong y Bim Bam - Elevación nueva y práctica de los martillos - Sonería plena y bonita que se ha obtenido por medio de una nueva disposición de los martillos Barilletes intercambiables - Se deja reparar facilmente

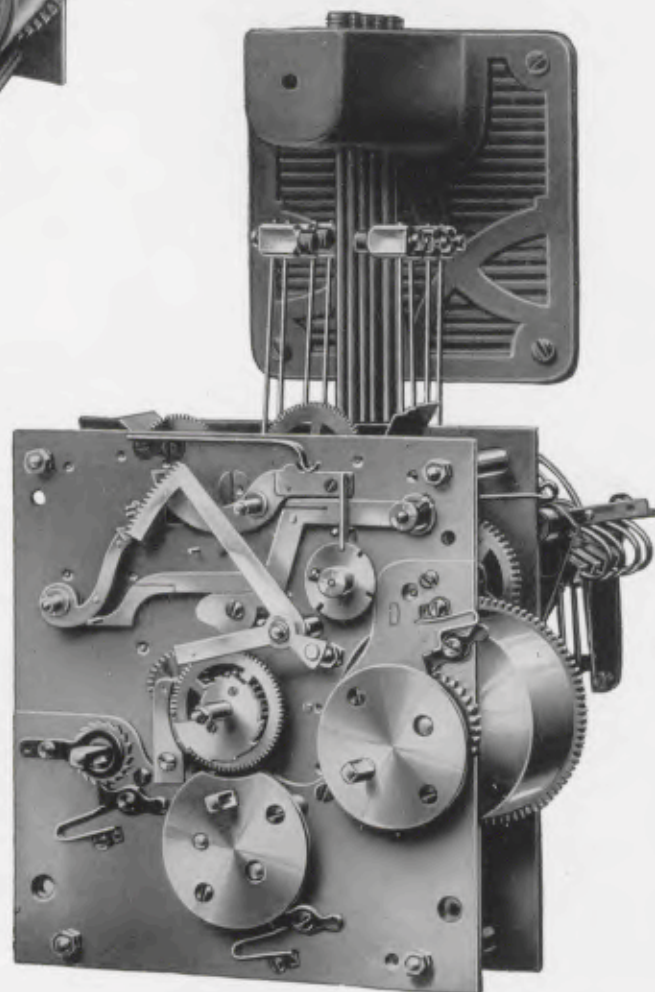

No. 103

Platinen - Plates - Platines - Platinas  
14,5 x 13,5 cm = 5<sup>3</sup>/<sub>4</sub> x 5<sup>1</sup>/<sub>4</sub> inches

8 Tag <sup>1</sup>/<sub>2</sub> Westminster-Schlagwerk No. 103 mit 5 Stäben - 8 day <sup>1</sup>/<sub>2</sub> Westminster chime movement No. 103 with 5 rodgongs 8 jours sonnerie <sup>1</sup>/<sub>2</sub> Carillon Westminster sur 5 tiges, mouvement No. 103 - 8 días sonería <sup>1</sup>/<sub>2</sub> Carillon Westminster sobre 5 varillas, máquina No. 103



Colombo



60 x 33 cm = 23<sup>1</sup>/<sub>2</sub> x 13 inches

Neu-Villach



49 x 23,5 cm = 19<sup>1</sup>/<sub>4</sub> x 9<sup>1</sup>/<sub>4</sub> inches

23/86 Eichenfarbig - Oak finish - Teinte chêne  
Color roble

23/87 Nußbaumfarbig - Walnut finish - Teinte  
noyer - Color nogal

Lack-Zifferblatt - Lacquered dial - Cadran  
verni - Esfera esmaltada

8 Tag Rechenschlag, offene Federn - 8 day half  
hour rack strike, open springs - 8 jours sonnerie  
à râteau heure et demie, ressorts découverts  
8 días sonería á sierra hora y media, cuerdas  
descubiertas

23/79 Nußbaum - Walnut - Noyer - Nogal

Silberblatt - Silver dial - Cadran argenté  
Esfera plateada 14,5 cm = 5<sup>3</sup>/<sub>4</sub> inches

14 Tag <sup>1</sup>/<sub>2</sub> Stund-Schlagwerk, Tonfeder - 14 day  
<sup>1</sup>/<sub>2</sub> hour strike, plain strike - 15 jours sonnerie,  
heures et demies, ressort timbre - 15 días  
sonería, horas y medias, sonería sobre bordón

Eichengehäuse in allen Eichenfarben lieferbar - Oak cases can be had in all oak colours  
Les cages chêne se livrent en toutes teintes de chêne - Las cajas de roble se hacen en todos los colores





Bruck I



54,5 x 25,5 cm = 21 1/2 x 10 inches

23/54 Nußbaum - Walnut  
Noyer - Nogal

23/55 Eiche - Oak  
Chêne - Roble

Bruck III



54,5 x 25,5 cm = 21 1/2 x 10 inches

23/60 Eiche - Oak  
Chêne - Roble

Bruck IV



54,5 x 25,5 cm = 21 1/2 x 10 inches

23/58 Nußbaum - Walnut  
Noyer - Nogal

23/59 Eiche - Oak  
Chêne - Roble

14 Tag 1/2 Stund-Schlagwerk, Tonfeder oder Stabgong

14 day 1/2 hour strike, plain strike or rod gong

15 jours sonnerie, heures et demies, ressort timbre ou gong tige

15 días sonería, horas y medias, sonería sobre bordón ó sonería sobre gong tija

Eichengehäuse in allen Eichenfarben lieferbar - Oak cases can be had in all oak colours

Les cages chêne se livrent en toutes teintes de chêne - Las cajas de roble se hacen en todos los colores

Silberblatt - Silver dial - Cadran argenté - Esfera plateada 15 cm = 6 inches



Gossau I und II



63,5 x 31,5 cm = 25 x 12 1/4 inches

24/111 Eiche - Oak - Chêne - Roble

24/112 Nußbaum - Walnut - Noyer - Nogal

Gewöhnliche Gläser - Plain glasses  
Verres simples - Vidrios ordinarios

24/113 Eiche - Oak - Chêne - Roble

24/114 Nußbaum - Walnut - Noyer - Nogal

Facettegläser - Bevelled glasses  
Glaces biseautées - Vidrios biselados

Tonfeder - Waldgong - Bachgong

Plain strike - Waldgong - Gong „Bim Bam“

Ressort timbre - Waldgong - Gong „Bim Bam“

Sonería sobre: Bordón - Waldgong - Gong „Bim Bam“

Gossau IV



63,5 x 31,5 cm = 25 x 12 1/4 inches

24/115 Eiche - Oak - Chêne - Roble

24/116 Nußbaum - Walnut - Noyer - Nogal

Eichengehäuse in allen Eichenfarben lieferbar - Oak cases can be had in all oak colours

Les cages chêne se livrent en toutes teintes de chêne - Las cajas de roble se hacen en todos los colores

Zifferblatt - Dial - Cadran - Esfera 18 cm = 7 inches



Meersburg



65 x 33 cm = 25 1/2 x 13 inches

24/93 Eiche - Oak - Chêne - Roble

Mit Messingverglasungen No. 113, 114 und No. 115 lieferbar

Can be had with brass mounted bevelled glasses No. 113, 114 and No. 115

Livable avec les glaces biseautées, serties sur laiton, No. 113, 114 et No. 115

Se suministra con los vidrios biselados No. 113, 114 y No. 115

Tonfeder - Waldgong - Bachgong - 1/4 Westminsterschlag

Plain strike - Waldgong - Gong „Bim Bam“ - 1/4 Westminster chime

Ressort timbre - Waldgong - Gong „Bim Bam“ - 1/4 Carillon Westminster

Sonería sobre bordón - Waldgong - Gong „Bim Bam“ - 1/4 Carillon Westminster

Eichengehäuse in allen Eichenfarben lieferbar - Oak cases can be had in all oak colours

Les cages chêne se livrent en toutes teintes de chêne - Las cajas de roble se hacen en todos los colores

Zifferblatt - Dial - Cadran - Esfera 18 cm = 7 inches

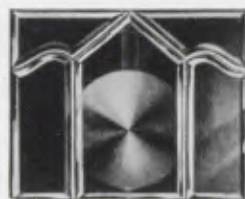

No. 113

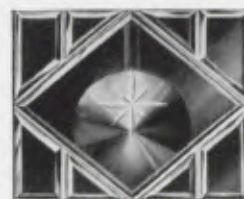

No. 114

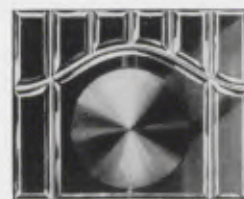

No. 115

Memel II



64 x 29,5 cm = 25 1/4 x 11 3/4 inches

24/91 Nußbaum - Walnut - Noyer Nogal

24/90 Eiche - Oak - Chêne - Roble

Memel III



64 x 29,5 cm = 25 1/4 x 11 3/4 inches

24/95 Nußbaum - Walnut - Noyer Nogal

24/96 Eiche - Oak - Chêne - Roble



Meiringen



64,5 x 30 cm = 25 1/2 x 12 inches

24/80

Mahagoni - Mahogany - Acajou - Caoba

Tonfeder - Waldgong - Bachgong - 1/4 Westminsterschlag

Plain strike - Waldgong - Gong „Bim Bam“ - 1/4 Westminster chime

Ressort timbre - Waldgong - Gong „Bim Bam“ - 1/4 Carillon Westminster

Sonería sobre bordón - Waldgong - Gong „Bim Bam“ - 1/4 Carillon Westminster

Zifferblatt - Dial - Cadran - Esfera 18 cm = 7 inches

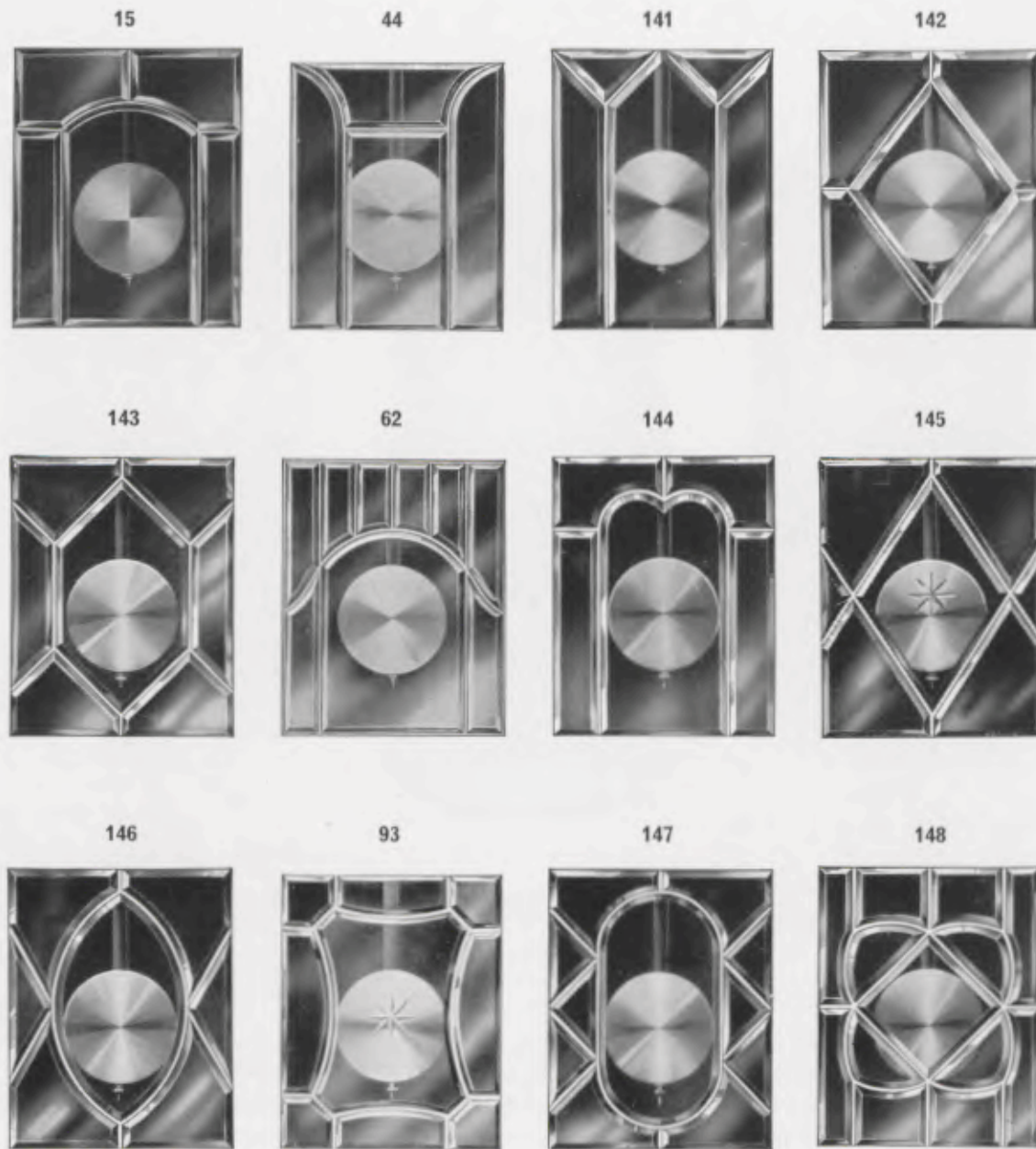

Die Regulateure der Gruppe 25 mit rechteckigen Verglasungen, ausgenommen 25/362, können auch mit den hier abgebildeten Messingverglasungen geliefert werden.

The regulators of group 25 fitted with square brass frames, except 25/362, can also be had with the above shown fittings.

Les régulateurs de la série 25 avec panneaux de glaces carrées, excepté le numéro 25/362, peuvent être fournis avec les panneaux glaces serties laiton suivant gravures ci-dessus.

Los reguladores del grupo 25 con vidrieras rectangulares, excepto el número 25/362, se montan además con las vidrieras de los adjuntos dibujos.



Kassel I und II



78 x 33 cm = 30 3/4 x 13 inches

- 25/466 Eiche - Oak - Chêne - Roble
- 25/467 Nußbaum - Walnut - Noyer - Nogal
- Gewöhnliche Gläser - Plain glasses
- Verres simples - Vidrios ordinarios
- 25/468 Eiche - Oak - Chêne - Roble
- 25/469 Nußbaum - Walnut - Noyer - Nogal

Facettegläser - Bevelled glasses  
Glaces biseautées - Vidrios biselados

Kassel IV



78 x 33 cm = 30 3/4 x 13 inches

- 25/470 Eiche - Oak - Chêne - Roble
- 25/471 Nußbaum - Walnut - Noyer - Nogal

Waldgong - Bachgong - 1/4 Westminsterschlag  
Waldgong - Gong „Bim Bam“ - 1/4 Westminster chime  
Waldgong - Gong „Bim Bam“ - 1/4 Carillon Westminster  
Sonería sobre Waldgong - Gong „Bim Bam“ - 1/4 Carillon Westminster

Eichengehäuse in allen Eichenfarben lieferbar - Oak cases can be had in all oak colours  
Les cages chêne se livrent en toutes teintes de chêne - Las cajas de roble se hacen en todos los colores

Zifferblatt - Dial - Cadran - Esfera 18 cm = 7 inches



Kiel I



78 x 33 cm = 30 3/4 x 13 inches

Kiel II



78 x 33 cm = 30 3/4 x 13 inches

Kiel IV



78 x 33 cm = 30 3/4 x 13 inches

25/367 Nußbaum - Walnut - Noyer  
Nogal

25/368 Eiche - Oak - Chêne - Roble

25/370 Eiche - Oak - Chêne - Roble

25/371 Nußbaum - Walnut - Noyer  
Nogal

25/372 Eiche - Oak - Chêne - Roble

Waldgong - Bachgong - 1/4 Westminsterschlag

Waldgong - Gong „Bim Bam“ - 1/4 Westminster chime

Waldgong - Gong „Bim Bam“ - 1/4 Carillon Westminster

Sonería sobre Waldgong - Gong „Bim Bam“ - 1/4 Carillon Westminster

Eichengehäuse in allen Eichenfarben lieferbar - Oak cases can be had in all oak colours

Les cages chêne se livrent en toutes teintes de chêne - Las cajas de roble se hacen en todos los colores

Zifferblatt - Dial - Cadran - Esfera 20,5 cm = 8 inches



Tölz I



75 x 33 cm = 29 1/2 x 13 inches

Tölz II



75 x 33 cm = 29 1/2 x 13 inches

Tölz V



75 x 33 cm = 29 1/2 x 13 inches

25/384 Eiche - Oak - Chêne  
Roble

25/386 Eiche - Oak - Chêne  
Roble

25/390 Nußbaum - Walnut  
Noyer - Nogal

25/391 Eiche - Oak  
Chêne - Roble

25/382 Mahagonifarbig  
Mahogany finish - Teinte  
acajou - Color caoba

Waldgong - Bachgong - 1/4 Westminsterschlag

Waldgong - Gong „Bim Bam“ - 1/4 Westminster chime

Waldgong - Gong „Bim Bam“ - 1/4 Carillon Westminster

Sonería sobre Waldgong - Gong „Bim Bam“ - 1/4 Carillon Westminster

Eichengehäuse in allen Eichenfarben lieferbar - Oak cases can be had in all oak colours

Les cages chêne se livrent en toutes teintes de chêne - Las cajas de roble se hacen en todos los colores

Zifferblatt - Dial - Cadran - Esfera 20,5 cm = 8 inches



Flensburg I



78 x 33 cm = 30 3/4 x 13 inches

25/416 Eiche - Oak - Chêne  
Roble

Flensburg II

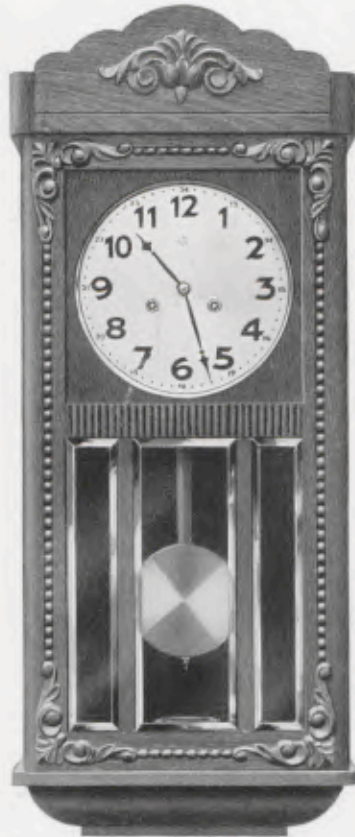

78 x 33 cm = 30 3/4 x 13 inches

25/418 Eiche - Oak - Chêne  
Roble

Flensburg III



78 x 33 cm = 30 3/4 x 13 inches

25/419 Nußbaum - Walnut  
Noyer - Nogal

25/420 Eiche - Oak - Chêne  
Roble

Waldgong - Bachgong - 1/4 Westminsterschlag  
Waldgong - Gong „Bim Bam“ - 1/4 Westminster chime  
Waldgong - Gong „Bim Bam“ - 1/4 Carillon Westminster  
Sonería sobre Waldgong - Gong „Bim Bam“ - 1/4 Carillon Westminster

Eichengehäuse in allen Eichenfarben lieferbar - Oak cases can be had in all oak colours  
Les cages chêne se livrent en toutes teintes de chêne - Las cajas de roble se hacen en todos los colores

Zifferblatt - Dial - Cadran - Esfera 20,5 cm = 8 inches



Flensburg IV



78 x 33 cm = 30 3/4 x 13 inches

25/422 Eiche - Oak - Chêne - Roble

Zifferblatt - Dial - Cadran  
Esfera 20,5 cm = 8 inches

Waldgong - Bachgong - 1/4 Westminsterschlag  
Waldgong - Gong „Bim Bam“ - 1/4 Westminster chime  
Waldgong - Gong „Bim Bam“ - 1/4 Carillon Westminster  
Sonería sobre Waldgong - Gong „Bim Bam“ - 1/4 Carillon Westminster

Eichengehäuse in allen Eichenfarben lieferbar - Oak cases can be had in all oak colours  
Les cages chêne se livrent en toutes teintes de chêne - Las cajas de roble se hacen en todos los colores

Guatemala III



78 x 36 cm = 30 3/4 x 14 inches

25/362 Nußbaum - Walnut - Noyer - Noga

25/363 Eiche - Oak - Chêne - Roble

Zifferblatt - Dial - Cadran  
Esfera 21,5 cm = 8 1/2 inches



Hall I



78 x 33 cm = 30 5/8 x 13 inches

25/432 Eiche - Oak - Chêne - Roble

Hall II



78 x 33 cm = 30 5/8 x 13 inches

25/433 Eiche - Oak - Chêne - Roble

Messingverglasung No. 139

Brass mounted bevelled glass

No. 139 - Glace biseauté,

sertie sur laiton, No. 139

Vidrio biselado No. 139

Hall II



78 x 33 cm = 30 5/8 x 13 inches

25/433 Eiche - Oak - Chêne - Roble

Messingverglasung No. 140

Brass mounted bevelled glass

No. 140 - Glace biseauté,

sertie sur laiton, No. 140

Vidrio biselado No. 140

Waldgong - Bachgong - 1/4 Westminsterschlag

Waldgong - Gong „Bim Bam“ - 1/4 Westminster chime

Waldgong - Gong „Bim Bam“ - 1/4 Carillon Westminster

Sonería sobre Waldgong - Gong „Bim Bam“ - 1/4 Carillon Westminster

In allen Eichenfarben lieferbar - Can be had in all oak colours

Peuvent être livrés en toutes teintes de chêne - Las cajas de roble se hacen en todos los colores

Zifferblatt - Dial - Cadran - Esfera 20,5 cm = 8 inches



Geislingen I



62 x 33 cm = 24 1/4 x 13 inches

25/426 Eiche - Oak - Chêne - Roble

Geislingen II



62 x 33 cm = 24 1/4 x 13 inches

25/427 Eiche - Oak - Chêne - Roble

Waldgong - Bachgong • Waldgong - Gong „Bim Bam“

In allen Eichenfarben lieferbar - Can be had in all oak colours

Peuvent être livrés en toutes teintes de chêne - Las cajas de roble se hacen en todos los colores

Zifferblatt - Dial - Cadran - Esfera 21,5 cm = 8 1/2 inches



Marburg I



78 x 33 cm = 30 3/4 x 13 inches

25/316 Mahagoni - Mahogany  
Acajou - Caoba

Marburg II



78 x 33 cm = 30 3/4 x 13 inches

25/317 Mahagoni - Mahogany  
Acajou - Caoba

Zifferblatt - Dial - Cadran - Esfera 20,5 cm = 8 inches

Waldgong - Bachgong - 1/4 Westminsterschlag

Waldgong - Gong „Bim Bam“ - 1/4 Westminster chime

Waldgong - Gong „Bim Bam“ - 1/4 Carillon Westminster

Sonerie sobre Waldgong - Gong „Bim Bam“ - 1/4 Carillon Westminster



GRUPPE 27

Aparte Wanduhren für die moderne Wohnung  
Smart wall clocks for the modern home - Pendules art nouveau pour intérieurs modernes  
Relojes de pared especiales para la casa moderna



45 x 24 cm = 18 x 9 1/2 inches

27/16 Eiche - Oak - Chêne - Roble

27/17 Nußbaum poliert - Polished walnut - Noyer poli  
Nogal pulido

Goldblatt - Gilt dial - Cadran doré - Esfera dorada  
16 x 16 cm = 7 x 7 inches

Tonfeder - Plain strike - Ressort timbre - Sonería sobre bordón

Einstabgong - Rod gong - Gong tige - Gong tija • Bim Bam 3 Stäbe - Gong „Bim Bam“: 3 rods - 3 tiges - 3 varillas



52 x 26 cm = 20 1/2 x 10 1/4 inches

27/18 Eiche - Oak - Chêne - Roble

Silberblatt - Silver dial - Cadran argenté - Esfera plateada 20 x 20 cm = 8 x 8 inches

27/19 Nußbaum gestreift, poliert - Striped walnut, polished  
Noyer rayé, poli - Nogal rayado, pulido

Goldblatt - Gilt dial - Cadran doré - Esfera dorada  
20 x 20 cm = 8 x 8 inches



57,5 x 31,5 cm = 22 3/4 x 12 1/4 inches

27/27 Eiche mit Nußbaumtüre - Oak with walnut door  
Chêne avec porte en noyer - Roble con puerta en nogal

27/28 Nußbaum - Walnut - Noyer - Nogal

Silberzahlenreif, verchromte Zahlen und Zeiger  
Silvered figure-circle, chromium plated figures and hands  
Cercle à chiffres argenté, chiffres et aiguilles chromés  
Cercos con cifras plateadas, cifras y agujas cromadas

Einstabgong - Rod gong - Gong tige - Gong tija • Bim Bam - Gong „Bim Bam“

Eichengehäuse in allen Eichenfarben lieferbar - Oak cases can be had in all oak colours  
Les cages chêne se livrent en toutes teintes de chêne - Las cajas de roble se hacen en todos los colores de roble



57,5 x 31,5 cm = 22 3/4 x 12 1/4 inches

27/29 Eiche - Oak - Chêne - Roble

Zifferblatt - Dial - Cadran - Esfera  
23 cm = 9 inches



50 x 29 cm = 19 1/2 x 11 1/2 inches

27/5 Eiche - Oak - Chêne - Roble



50 x 29 cm = 19 1/2 x 11 1/2 inches

27/6 Eiche mit kaukasisch Nußbaum poliert  
Oak with polished Caucasian walnut  
Chêne avec noyer Caucasiens poli  
Roble con nogal Cáucaso pulido



50 x 30 cm = 19 3/4 x 11 3/4 inches

27/22 Zahlen - Figures - Chiffres - Cifras  
27/23 Striche - Strokes - Barres - Rayas

Kaukasisch Nußbaum poliert  
Polished Caucasian walnut  
Noyer Caucasiens poli  
Nogal Cáucaso pulido

Einstabgong - Rod gong - Gong tige - Gong tija  
Bim Bam 4 Stäbe - Gong „Bim Bam“: 4 rods - 4 tiges - 4 varillas

27/5: In allen Eichenfarben lieferbar - Can be had in all oak colours  
Se livrent en toutes teintes de chêne - Se hacen en todos los colores de roble



48 x 29 cm = 18 7/8 x 11 3/4 inches

27/24 Zahlen - Figures - Chiffres - Cifras  
27/25 Striche - Strokes - Barres - Rayas

Kaukasisch Nußbaum poliert  
Polished Caucasian walnut  
Noyer Caucasiens poli  
Nogal Cáucaso pulido



49,5 x 30 cm = 19 1/2 x 11 3/4 inches

27/20 Zahlen - Figures - Chiffres - Cifras

27/21 Striche - Strokes - Barres - Rayas

Kaukasisch Nußbaum poliert, abgerundete Türkante - Polished Caucasian walnut, rounded dooredge - Noyer Caucasiens poli, porte arrondie - Nogal Cáucaso pulido, puerta redondeada

Einstabgong - Rod gong - Gong tige - Gong tija

Bim Bam 4 Stäbe - Gong „Bim Bam“: 4 rods - 4 tiges - 4 varillas



32 x 30 cm = 12 1/2 x 11 3/4 inches

27/15 Kaukasisch Nußbaum poliert  
Polished Caucasian walnut  
Noyer Caucasiens poli  
Nogal Cáucaso pulido

Aufgelegter Silberzahlenreif  
Raised silver figure-circle  
Cercle à chiffre argenté appliqué  
Cercos con cifras plateado aplicado

8 Tag Ankergehwerk mit Echappement  
8 day lever time movement with escapement  
8 jours simple, échappement à ancre  
Máquina 8 días cuerda, escape á áncora

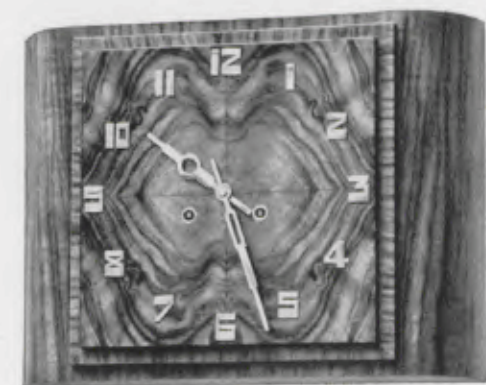

28,5 x 35 cm = 11 1/4 x 13 3/4 inches

27/26 Kaukasisch Nußbaum poliert  
Polished Caucasian walnut  
Noyer Caucasiens poli  
Nogal Cáucaso pulido

Verchromte Zahlen und Zeiger  
Chromium plated figures and hands  
Chiffres et aiguilles chromés  
Cifras y agujas cromadas

14 Tag Ankerschlagwerk mit Echappement  
14 day lever strike movement with escapement  
15 jours sonnerie à ancre avec échappement  
15 días sonería, escape á áncora

Bim Bam 3 Stäbe - Gong „Bim Bam“:  
3 rods - 3 tiges - 3 varillas





GRUPPE 28

*Dielenuhren*

Hall clocks - Horloges de parquet - Relojes de recibidor

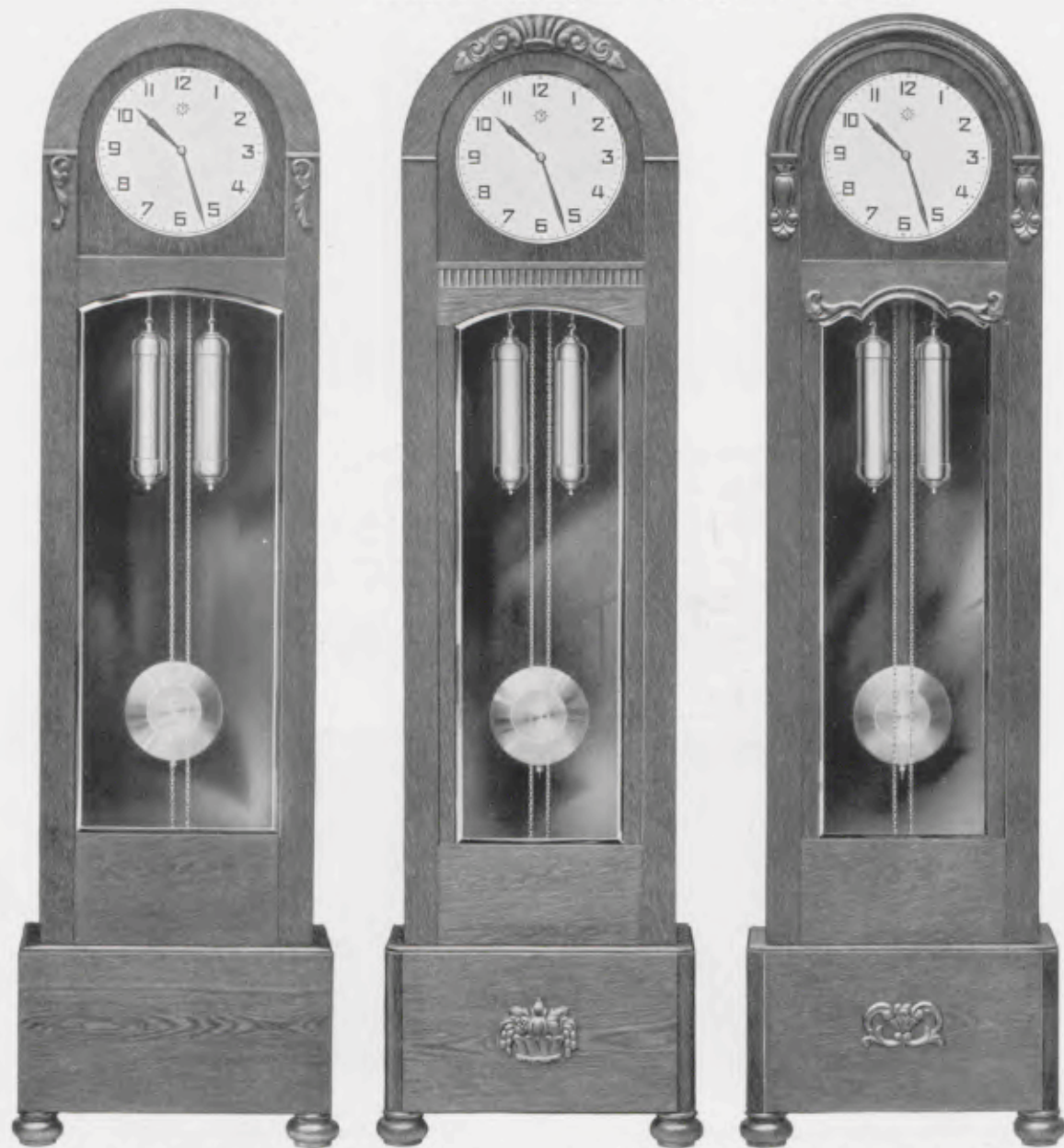

198 x 55 cm = 78 x 21 1/4 inches

198 x 55 cm = 78 x 21 1/4 inches

190 x 55 cm = 78 x 21 1/4 inches

- 28/154 Eiche - Oak - Chêne - Roble  
 Flachglas - Flat glass - Verre plat - Vidrio plano
- 28/155 Eiche - Oak - Chêne - Roble  
 Facetteglas - Bevelled glass  
 Verre biseauté - Vidrio biselado
- 28/156 Eiche - Oak - Chêne - Roble  
 Nußbaum poliert  
 Polished walnut - Noyer poli  
 Nogal pulido
- 28/157 Eiche - Oak - Chêne - Roble

Zifferblatt - Dial - Cadran - Esfera 29,5 cm = 12 inches

Eichengehäuse in allen Eichenfarben lieferbar - Oak cases can be had in all oak colours  
 Les cages chêne se livrent en toutes teintes de chêne - Las cajas de roble se hacen en todos los colores de roble

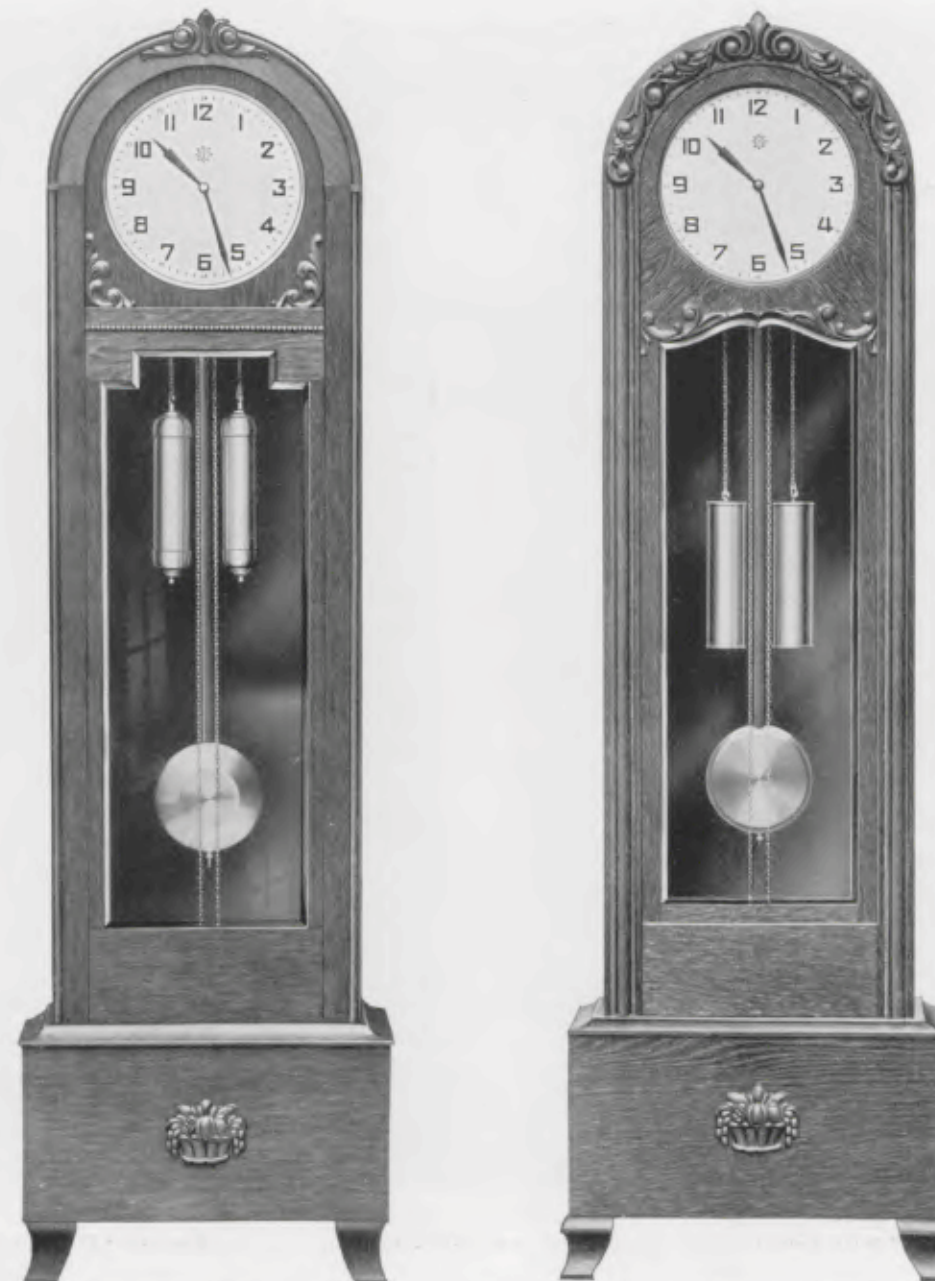

200 x 61 cm = 79 x 24 inches

200 x 61 cm = 79 x 24 inches

28/158

28/159

Eiche - Oak - Chêne - Roble

Zifferblatt - Dial - Cadran - Esfera 33 cm = 13 inches

In allen Eichenfarben lieferbar - Can be had in all oak colours  
 Se livrent en toutes teintes de chêne - Se hacen en todos los colores de roble

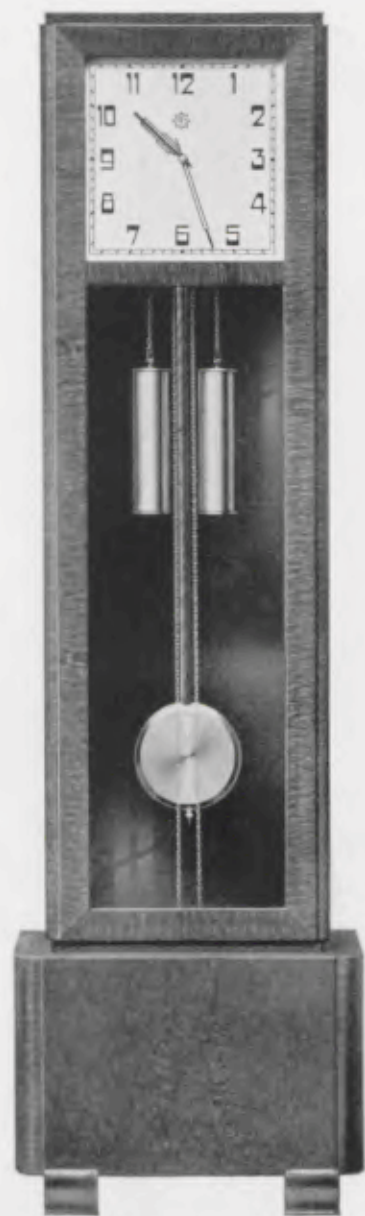

190 x 56 cm = 75 x 22 inches

28/160

Eiche - Oak - Chêne - Roble

Silberblatt mit schwarzen Zahlen  
Silver dial with black figures  
Cadran argenté avec chiffres noirs  
Esfera plateada con cifras negras  
33 x 33 cm = 13 x 13 inches

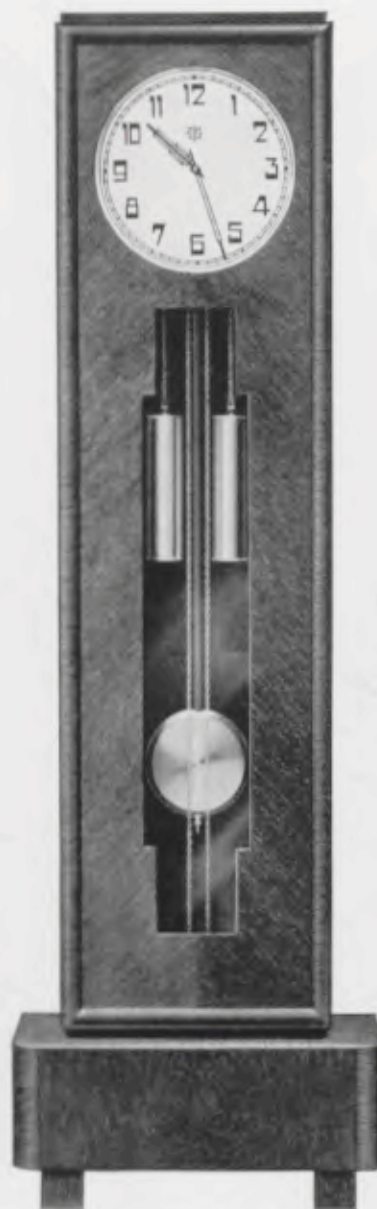

190 x 60 cm = 75 x 23 1/4 inches

28/162

Eiche - Oak - Chêne Roble

Silberblatt mit blauen Zahlen  
Silver dial with blue figures  
Cadran argenté avec chiffres bleus  
Esfera plateada con cifras azules  
33 cm = 13 inches

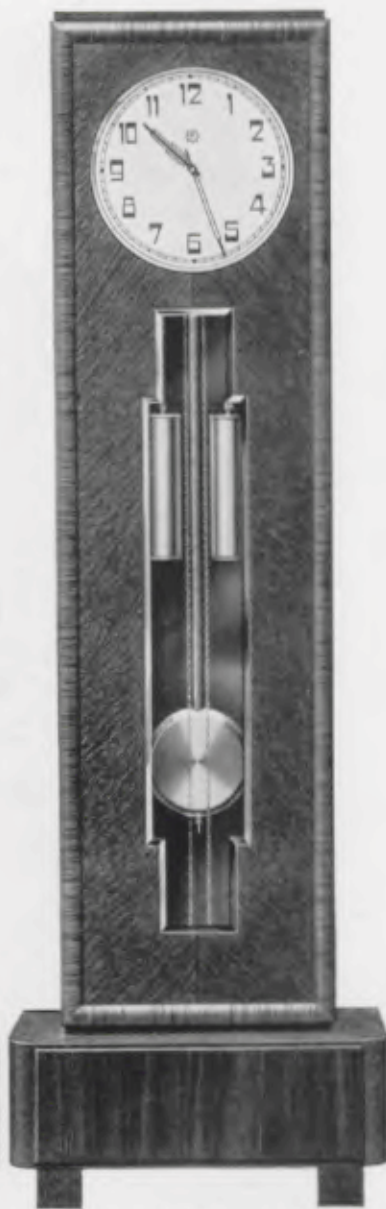

190 x 60 cm = 75 x 23 1/4 inches

28/163

Eiche mit Nußbaum poliert - Oak  
with polished walnut - Chêne avec  
noyer poli - Roble con nogal pulido

Silberblatt mit blauen Zahlen  
Silver dial with blue figures  
Cadran argenté avec chiffres bleus  
Esfera plateada con cifras azules  
33 cm = 13 inches

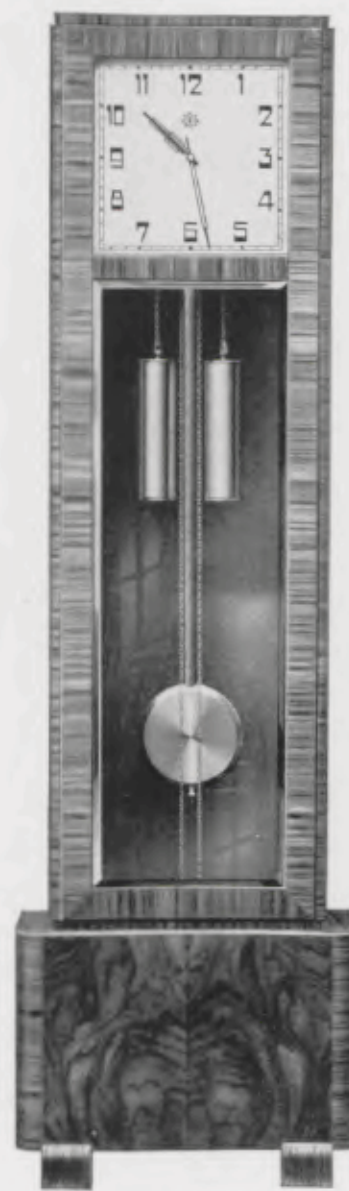

190 x 56 cm = 75 x 22 inches

28/164 Front und Sockel kaukasisch Nußbaum poliert

Front and base polished Caucasian walnut  
Façade et socle noyer Caucasiens poli  
Frente y zócalo nogal Cáucaso pulido

Goldblatt mit schwarzen Zahlen  
Gilt dial with black figures  
Cadran doré avec chiffres noirs  
Esfera dorada con cifras negras  
33 x 33 cm = 13 x 13 inches

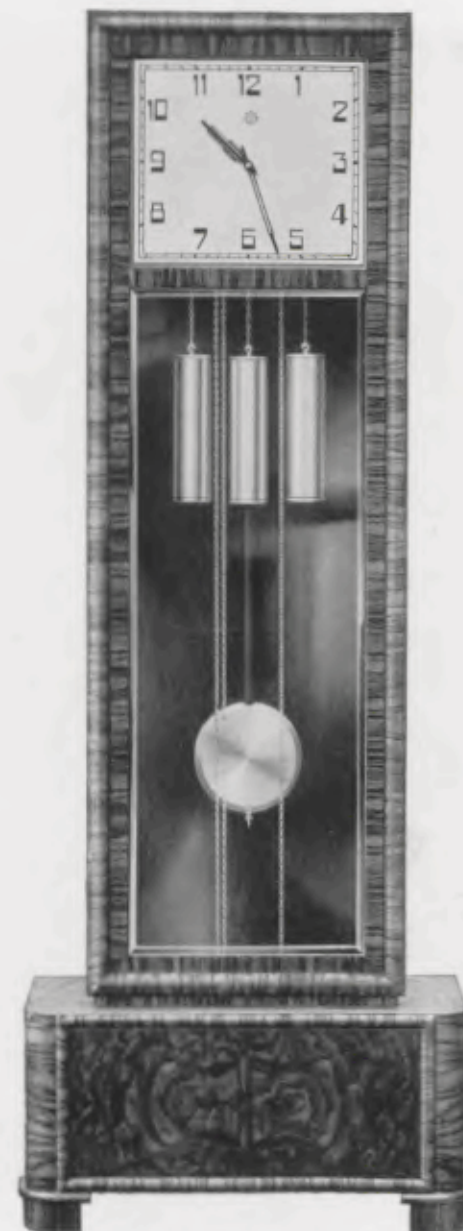

192 x 73 cm = 75 1/2 x 28 3/4 inches

28/166 Kaukasisch Nußbaum poliert

Polished Caucasian walnut  
Noyer Caucasiens poli  
Nogal Cáucaso pulido

Silberblatt mit blauen Zahlen  
Silver dial with blue figures  
Cadran argenté avec chiffres bleus  
Esfera plateada con cifras azules  
33 x 38 cm = 13 x 15 inches



